

# Kantoormeubilair van A tot Z

2024

Ontvangen

Werken

Vergaderen

Opbergen

Directie

Zitten



[www.swan-products.nl](http://www.swan-products.nl)

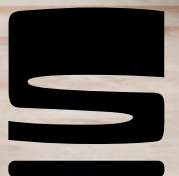

Prijs 6.95



Sittland

Un modello di sostenibilità per Sittland

**ECONA**

Our sustainable approach to design

Een kantoor inrichten is een vak apart. U krijgt te maken met ergonomie op de werkplek, akoestiek, normeringen, efficiency, maar bovenal uw eigen smaak en specifieke praktische wensen. Deze catalogus sluit hier perfect op aan en biedt u een totaalaanbod van A tot Z.

Onze gids informeert, adviseert en motiveert u bij het maken van de juiste keuzes voor de totale invulling van uw kantoor- en projectinrichting.

De getoonde producten worden geproduceerd volgens de strengste internationale normen waarbij kwaliteit, duurzaamheid en milieubelasting uiteraard optimale aandacht krijgen. Per pagina ziet u land van herkomst en algemene iconen over relevante aspecten van het getoonde product.



## Scan voor prijslijst

Voor actuele prijzen en opties kunt u eenvoudig met de camera van uw mobiel het handje met de QR-code scannen. Hier treft u vervolgens de aparte prijslijst met alle uitvoeringen en mogelijkheden van de getoonde producten, aangevuld met handige informatie en afbeeldingen. Vraag ons ook gerust naar de papieren versie van de prijslijst, wij helpen u graag.



In de catalogus treft u bovenin diverse icoontjes, hieronder leggen we ze even uit.



VOORRAAD

Deze producten zijn op voorraad dus snel leverbaar.



LEVERTIJD

Producten die speciaal voor u gemaakt worden met de verwachte levertijd.



GARANTIE

Garantie op uw producten aangeduid in aantal jaar.



CIRCULAIR

Deze producten zijn herbruikbaar (second life) en recyclebaar.



DUURZAAM

Vanaf de bron aantoonbaar milieuvriendelijk en duurzaam geproduceerd.



ARBO KEUR

Voldoet aan de ARBO eisen voor veilig en gezond werken.



AKOESTIEK

Hiermee biedt u akoestische oplossingen voor uw ruimte.



MAATWERK

Staat dit erbij dan is maatwerk op aanvraag ook mogelijk.



OOK VOOR BUITEN

UV-bestendige producten, geschikt voor binnen én buiten.



CONFIGUREERBAAR

Deze producten zijn online te configureren.



MODULAIR

Werkplekken met modulaire onderstellen voor optimale flexibiliteit.



MONTAGE

Dit zijn producten die op locatie nog (af-)gemonteerd moeten worden.



## Ontvangen

12 - 47

Z1 balies	12 - 15
Z2 balies	16 - 19
To Go	20 - 21
Lido	22 - 23
Astro Twist	24 - 25
Avana	26 - 27
Dodo, Joy en Moon	28 - 29
Cleopas	30 - 31
City Lounge en City Déco Lounge	32 - 33
Millos Lounge, Rest en Bistrot	34 - 35
Ado	36 - 37
Canapé	38 - 39
Cell 128 en Cell Space	40 - 41
Cell 72 en Cell 75	42 - 43
Askia Kameleon	44 - 45
Salontafels	46 - 47



## Werken

48 - 123

Een goede werkplek	48 - 51
Entrada	52 - 53
Arca	54 - 55
Air2	56 - 57
Componenten	58 - 61
PL-1 en PL-S	62 - 63
Neutral	64 - 65
Elite en Q4 ladenblokken	66 - 67
Idea+ Tube en Idea+ 01	68 - 69
X4 werkplekken en Q4 wanden	70 - 71
S-Light slinger	74 - 75
Flex Raster	76 - 77
S-Line single en bench	78 - 79
Flex Eco+	80 - 81
Flex 3+	82 - 93
Flex 3+ manager	94 - 95
Flex accessoires	96 - 97
Follow Desk	98 - 99
Akoestische wanden	100 - 111
Eco-Light verlichting	112 - 113
Q4 Lighting	114 - 117
Kabelmanagement en elektrificatie	118 - 121
CPU-houders en monitorarmen	122 - 123



## Vergaderen

124 - 157

Turn & Go	126 - 127
Timmy-R	128 - 129
Argo Libro	130 - 131
Timmy Libro	132 - 133
Air2 Co-Work	134 - 135
Entrada, Arca en Air2 vergadertafels	136 - 137
Bartafels en 4-All kantinetafels	138 - 139
Tmeeting 1	140 - 141
Tmeeting 3	142 - 142
Tmeeting 4	144 - 145
Kolomtafels	146 - 147
Q4 meeting	148 - 149
Follow meeting en Follow tilting	150 - 151
Flex 3+ meeting	152 - 153
Freestand	154 - 155
Electrificatie vergadertafels	156 - 157

## Opbergen

158 - 183

Slide & Go schuifdeurkasten	160 - 163
Ecotec roldeurkasten	164 - 165
New Generation roldeurkasten	166 - 167
Roldeurkast ombouwsets, plantenbakken en accessoires	168 - 169
Metalen draaideurkasten en open kasten	170
Metalen lockerkasten	171 - 173
Q4 melamine kasten	174 - 175
Q4 metalen kasten	176 - 177
Q4 schuifdeurkasten en lockerkasten	178 - 179
Libreria boekenkasten	180 - 181
Boiserie open kasten	182 - 183



## Directie

184 - 199

T45 bureaus	186 - 187
T45 meeting	188 - 189
X5 bureaus en meeting	190 - 191
X7 bureaus en meeting	192 - 193
X8 bureaus en meeting	194 - 195
E-10 bureaus en meeting	196 - 197
X-10 bureaus en meeting	198 - 199



## Zitten

200 - 281

SW-1 bureaustoelen	202 - 203
NPR bureaustoelen	204 - 209
Bureaustoelen	210 - 223
Manager- en directiestoelen	224 - 235
Conferentie- en vergaderstoelen	236 - 267
Terras- en kantinstoelen	268 - 281
Stofkleuren overzicht	282 - 299
Index	302 - 305





## Quadrifoglio Group



Made in Italy met Quadrifoglio Group, zo ziet een hedendaagse fabrikant eruit na meer dan 30 jaar innovatie op gebied van kantoormeubilair. Ondertussen is de groep van Quadrifoglio uitgegroeid tot een totaal leverancier van onder andere meubilair, stoelen, soft seating, verlichting en akoestische oplossingen.

Schitterend gelegen aan de voet van de Dolomiti is het compleet vernieuwde fabriekscomplex nu een toonbeeld van duurzame en efficiënte productie van slimme en prachtige oplossingen.

Duurzaam produceren gaat steeds verder en wordt steeds belangrijker in de transparante processen van Quadrifoglio. Ondertussen bestaat 98% van het gewicht in ruwe materialen uit gerecycled materiaal en worden alle melamine bladen en panelen vervaardigd uit gebruikt hout (Ecological panel certification, bron: Sustainability report Quadrifoglio 2022).

Daken vol zonnepanelen, lokale leveranciers en een uniek afval management systeem (60% wordt herbruikt in nieuwe materialen) geven aan dat Quadrifoglio écht bezig is met een duurzame toekomst!



Veel producten komen pas tot stand nadat Italiaanse designers er hun visie over hebben gegeven. Bekende namen als Dorigo, Dolcini, Caini design en anderen geven de producten hun kenmerkende look & feel en zorgen voor de perfecte finishing touch!

Een breed assortiment met zeer snelle levertijden geven dit merk een wereldwijd aanzien waar wij al bijna 20 jaar als trotse partner mee samenwerken.



Het Italiaanse Sitland is gelegen in de prachtige omgeving van Vicenza midden in het technologische epicentrum van de vele toeleveranciers in de meubelindustrie. Met een ongekende prijs-kwaliteit is de grootste stoelenfabrikant van Italië een wereldwijd opererende fabrikant van bureaustoelen, vergaderstoelen en ontvangstmeeubelair.

Vakmanschap meesterschap, ruik de geur van prachtig leder en hoor het gezoem van naaimachines waar de mooiste ontwerpen van vooraanstaande designers tot leven komen. Denk aan de prachtige Vega serie, de bestseller vergaderstoelen Passepartout en Uni, de unieke vormgeving van de Cell Space of de innovatieve Skate bureaustoel, allen smaakmakers in uw interieur.



Maar liefst 80% van de toeleveranciers komen uit de buurt, echt made in Italy dus!

Overall waar u het fraaie Sitland logo ziet, kunt u rekenen op 100% vakmanschap met oog voor detail én... de toekomst.



ECONA is hét keurmerk waarmee Sitland naast duurzaam materiaalgebruik ook alle relevante processen definieert, van samenstelling tot productie en van onderhoudsvriendelijkheid tot circulariteit. Alles duidelijk in kaart gebracht, de ideale combi van vormgeving en optimale kwaliteit voor de inrichting die letterlijk goed voelt.



Company with quality, environment and safety management system certified according to ISO 9001, ISO 14001, ISO 45001



Dorigo Design



Bertolini Ferrarese Scagnellato



Baldanzi Novelli

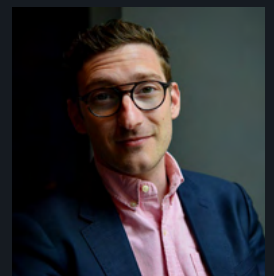

Adrian Blanc

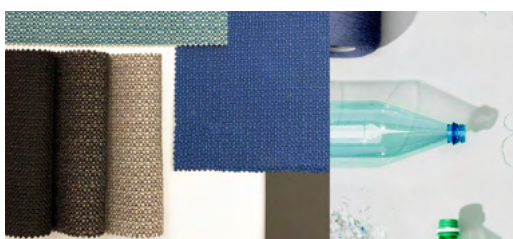

Diverse stoffen uit de Sitland collectie zijn geproduceerd uit 100% gerecycled materiaal en daardoor dus 100% duurzaam.

Sitland volgt de European Green Deal. De groene keuze voor producten en materialen.



Het Italiaanse Gaber behoort al decennia lang tot de betere producenten in de wereld van spuitgietmallen voor kunststof. Vanuit de passie voor mooie producten en de aanwezige technologische kennis heeft Gaber een groeiend assortiment stoelen en tafels ontwikkeld.

Met een totale oppervlakte van 50.000m2 productie en opslag en meer dan 200 gemotiveerde medewerkers, werkt Gaber aan de nieuwste modellen die wereldwijd worden geleverd.

Made in Italy met een jonge en open blik op de toekomst van onze planeet. De omvangrijke collectie met bestsellers als de Kanvas en Bakhita alsook vele innovatieve nieuwe producten zoals de Dame kuipstoelen zijn enkele voorbeelden van het grote aanbod van Gaber.

Gaber produceert volgens de hoogste milieunormen. Zo liggen de daken vol met zonnepanelen waarmee de productie, verlichting en airconditioning wordt voorzien.



RECYCLE



REDUCE



REUSE



Gaber produceert haar producten van 100% recyclebaar materiaal. Deze technoplastics worden verwerkt zonder chemische toevoegingen.

Houten producten worden vervaardigd volgens de Europese regelgevingen mbt Formaldehyde emissies ((E1 volgens EN717-EN120). Gaber gebruikt ruwe materialen afkomstig van de PEFC chain of custody.

Dit prachtige logo staat dus gegarandeerd voor kwaliteit, duurzaamheid en Italiaans vakmanschap.





Mara is een historisch Italiaans bedrijf dat gespecialiseerd is in de productie van innovatieve, esthetische en veelal gepatenteerde meubelsystemen voor op kantoor en in het dagelijks leven. Een nauwkeurig eigen onderzoekslab en geavanceerde technieken stellen Mara in staat om alle processen in eigen huis uit te voeren binnen haar productiefaciliteiten in Brescia: van lasersnijden tot lassen, en van poedercoaten tot verpakken.

Mara zet zich altijd in voor het milieu middels duurzame ontwikkelingen en intelligente consumptie. Van ontwerp tot productie, elke stap wordt zorgvuldig doordacht en geanalyseerd, waarbij energie- en materiaalverspilling tot een minimum worden beperkt, een win-win situatie voor zowel de producent als onze wereld.



100% van haar energieconsumptie betreft Mara van zelf opgewekte groene stroom.

Het Spaanse Gapsa produceert al meer dan 25 jaar roldeur- en lockerkasten met de hoogste kwaliteit en maximale aandacht voor het milieu. Hierdoor is Gapsa uitgegroeid tot Europa's grootste fabrikant op dit gebied.

Met de gerobotiseerde productiestraten en nieuwste technieken is Gapsa in staat om haar kasten supersnel, met behoud van een constante kwaliteit, te produceren.



Bekende Gapsa producten zijn de intelligente lockerkasten, de roldeurkasten van de New Generation serie en natuurlijk de exclusief voor Nederland geproduceerde Ecotec kasten.

Gapsa: al 25 jaar een belangrijk merk binnen ons assortiment.



Vanaf het moment dat het ruwe staal binnen komt tot het uiteindelijke product dat in de trailer wordt geladen, zorgt Gapsa voor een efficiënte werkwijze waarbij minimale verspilling wordt nagestreefd. Alles met oog voor het optimaal duurzaam produceren. Vanzelfsprekend volgt Gapsa de allerhoogste normen en Europese regelgeving op gebied van milieu.



ISO 9001  
ISO 14001

BUREAU VERITAS  
Certification





Met liefde ontworpen en geproduceerd in Roemenië. Askia is de fabrikant van de indrukwekkende Kameleon-serie en levert hiermee, alles in-house en zeer snel, een prachtig breed programma akoestische pod-oplossingen.

Uniek is de online configurator, waarmee zeer eenvoudig de gewenste versie, indeling en uitvoering kan worden gekozen, lekker visueel en heerlijk gebruiksvriendelijk. Bijkomend voordeel is de snelle montage en demontage, middels vooraf geassembleerde elementen die u in staat stellen om de pod makkelijk in elkaar te steken of aan te passen... een echte Kameleon.

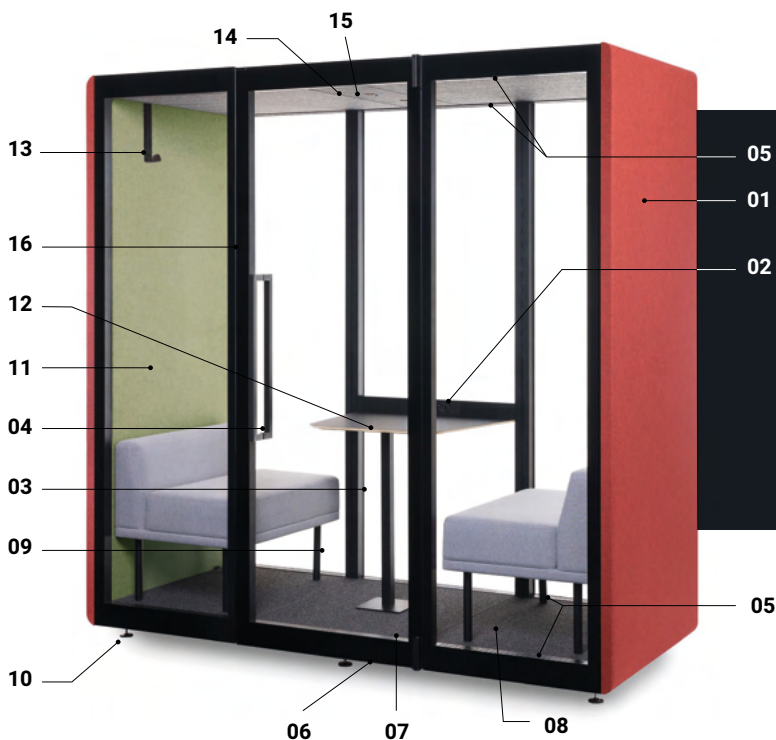

Askia is een merk van het Roemeense Arcade Group, en gebruikt haar omvangrijke productiefaciliteiten voor de nieuwe en innovatieve ontwerpen van hun jonge designbureau ARS (Askia Research Studio). Een dynamisch DNA van passie en nieuwe technische oplossingen.

De naam Askia komt van het Roemeense "aschia" wat houtsnipper betekent; één van de belangrijkste en oudste bouwstenen in onze wereld. Askia wil de bouwsteen zijn voor nieuwe duurzame en vriendelijke producten, tijdloze oplossingen die ons werk en leven aangenamer kunnen maken. Hierbij krijgt niet alleen het eindproduct, maar ook verpakking en transportvolume, alle aandacht wat leidt tot aantoonbare en zeer verrassende oplossingen.







Geef uw ontvangstruimte het welkom-gevoel met een passende balie en comfortabele zitelementen.

Maak de perfecte eerste indruk met één van de prachtige balieseries van Quadrifoglio.

Kies voor de rechte lijnen van Z1 of de veelzijdigheid van Z2 waarbij gekozen kan worden voor diverse afwerkniveaus en opties.



Quadrifoglio Group

Balie elementen

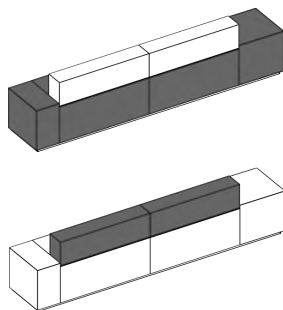

Mat lak kleuren

LT Beige grey	LL Grey white	LS Silk grey	LA Orange	LB White	LE Beige	LO Umbra grey	LG Grey
LR Purple red	LF Tele grey 4	LC Pigeon blue	LZ Sapphire blue	LN Traffic black	LH Flame red	LD Ocean blue	LI Black red
LP Pine green	NW Ocher	NV Olive green	NU Dark brown	NJ Burnt orange	NK Light beige	NQ Cobalt blue	

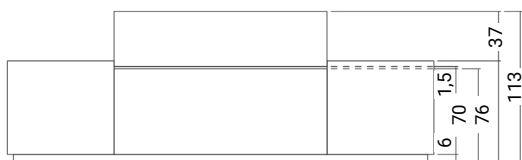

Frontaanzicht met hoogtes Z1 balie

Metalen elementen

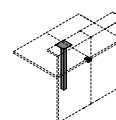

Kleuren

I White	R Anthracite
------------	-----------------

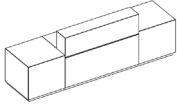
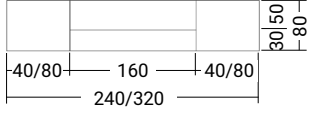
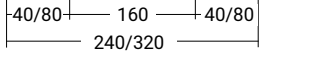
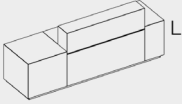
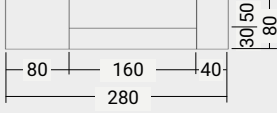
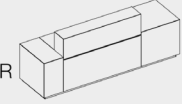
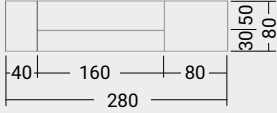
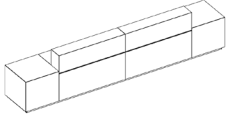
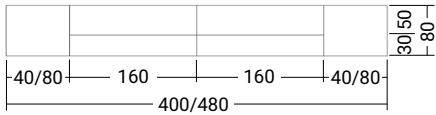
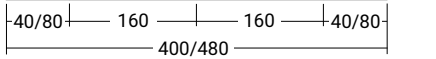
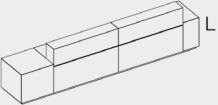
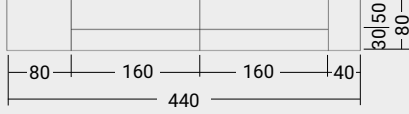
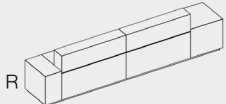
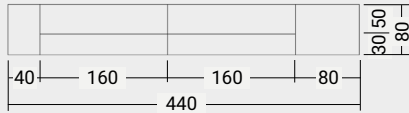
Opstelling		b x d x h (cm)	Code
		240 x 80 x 113	Z1C01240
		320 x 80 x 113	Z1C01320
		280 x 80 x 113	Z1S01280
			280 x 80 x 113
		400 x 80 x 113	Z1C01400
		480 x 80 x 113	Z1C01480
		440 x 80 x 113	Z1S01440
			440 x 80 x 113

Werkbladhoogte 76cm hoog



- Aluminium afwerkprofiel
- Led strip onderzijde balie
- Led strip onderzijde opzetmodule





**Balie modules, zijpanelen, (top)bladen en lage counters**

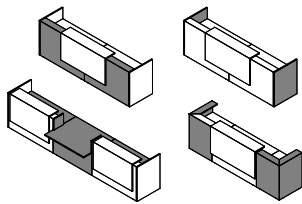

Melamine kleuren



**Opzet elementen**

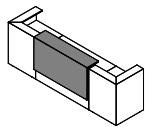

Melamine kleuren

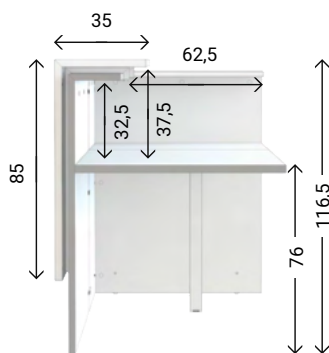

Mat lak kleuren (4-6 weken levertijd)

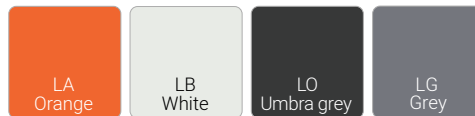

Mat lak of eigen RAL kleuren (6-8 weken levertijd)



Leder kleuren (meerprijs)



**Metalen elementen**

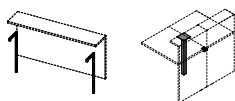

Kleuren



- 1 Led verlichting onder opzetelementen
- 2 Lage balie module in diverse breedtes leverbaar
- 3 Werkplekverlichting (LED met soft touch)
- 4 Opzetmodule in diverse afwerkingen en maatvoeringen

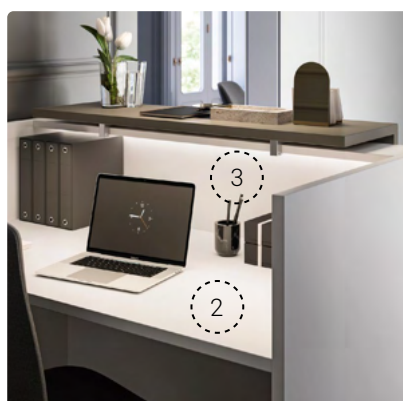
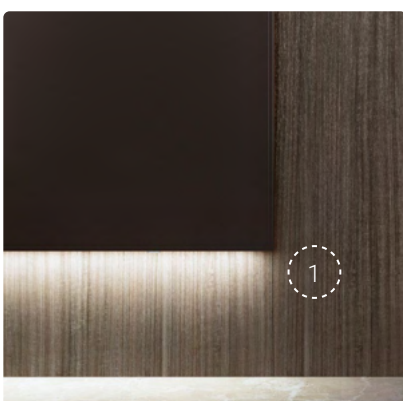



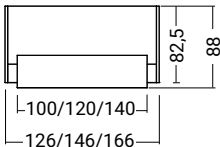
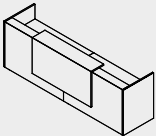
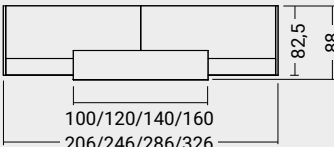
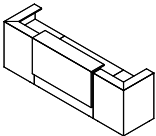
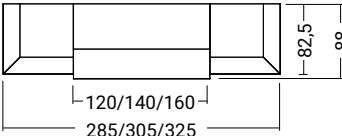
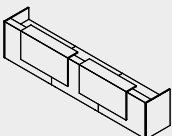
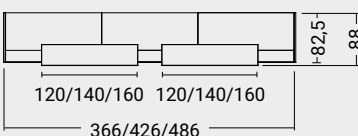
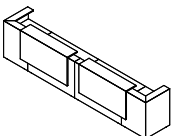
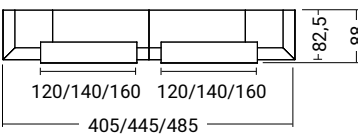
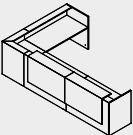
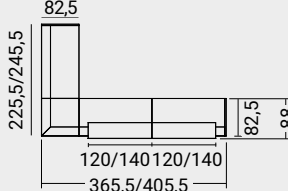
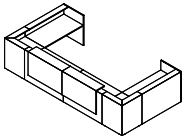
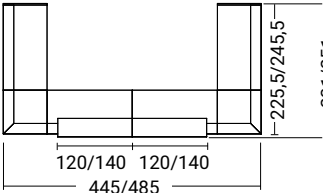
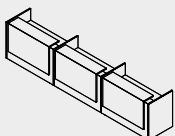
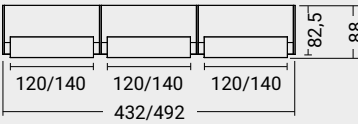

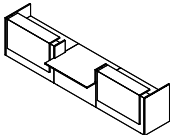
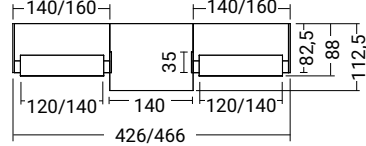
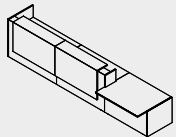
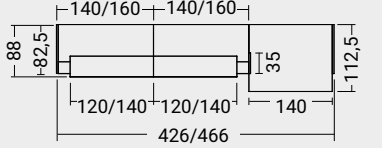
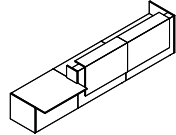
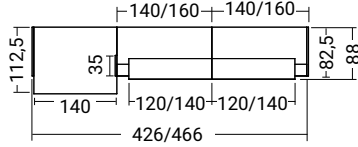
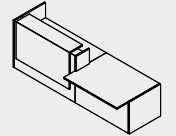
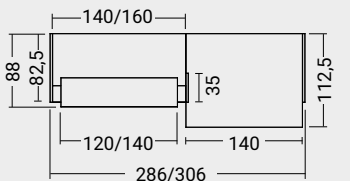
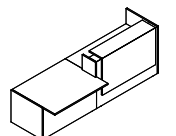
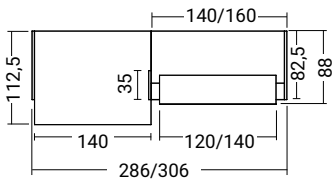

Opstelling	b x d x h (cm)	Code
 	<p>126 x 88 x 116,5 146 x 88 x 116,5 166 x 88 x 116,5</p>	<p>Z2C71 Z2C72 Z2C73</p>
 	<p>206 x 88 x 116,5 246 x 88 x 116,5 286 x 88 x 116,5 326 x 88 x 116,5</p>	<p>Z2C04 Z2C01 Z2C02 Z2C03</p>
 	<p>285 x 88 x 116,5 305 x 88 x 116,5 325 x 88 x 116,5</p>	<p>Z2C05 Z2C06 Z2C07</p>
 	<p>366 x 88 x 116,5 426 x 88 x 116,5 486 x 88 x 116,5</p>	<p>Z2C10 Z2C11 Z2C12</p>
 	<p>405 x 88 x 116,5 445 x 88 x 116,5 485 x 88 x 116,5</p>	<p>Z2C20 Z2C21 Z2C22</p>
 	<p>365,5 x 225,5 x 116,5 405,5 x 245,5 x 116,5</p>	<p>Z2C25 Z2C26</p>
 	<p>445 x 231 x 116,5 485 x 251 x 116,5</p>	<p>Z2C30 Z2C31</p>
 	<p>432 x 88 x 116,5 492 x 88 x 116,5</p>	<p>Z2C35 Z2C36</p>

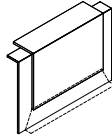

Opstelling		b x d x h (cm)	Code
		426 x 112,5 x 116,5 466 x 112,5 x 116,5	Z2C40 Z2C41
		426 x 112,5 x 116,5 466 x 112,5 x 116,5	Z2C45 Z2C46
		426 x 112,5 x 116,5 466 x 112,5 x 116,5	Z2C50 Z2C51
		286 x 112,5 x 116,5 306 x 112,5 x 116,5	Z2C55 Z2C56
		286 x 112,5 x 116,5 306 x 112,5 x 116,5	Z2C57 Z2C58

Werkbladhoogte 76cm hoog

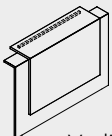
Opties LED verlichting onder opzetelement	Lengte (cm)	Code
	 100	Z2E04
	 120	Z2E01
	 140	Z2E02
	 160	Z2E03
 Verlichting op werkblad met softtouch	98	Z2E10

Kabelklep met borstelafwerking	b x d x h (cm)	Code
	30 x 12 x 12	ACVAF04
	45 x 12 x 12	ACVAF03

Incl. freezen van gat in werkblad (plaats opgeven)





To-Go bestaat uit drie hoofdelementen: de zitting, de rugleuning en de arMLEuning. Vrijstaande elementen met zachte vormen maken het mogelijk om zeer eenvoudig wachtruimtes, openbare- of loungeruimtes in te richten.

Design by Favaretto & Partners

Gaber®

Model



To Go poef

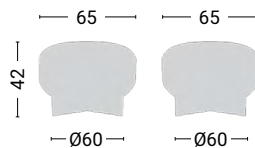

To Go met rug



To Go met rug en armleuning

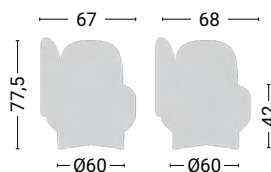

Onderstel kleuren

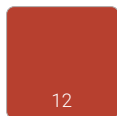

Stofferingen



**King Trevira CS**  
100% Polyester



**Kvadrat Steelcut 3**  
90% New Wol  
10% Nylon

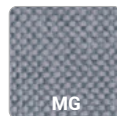

**Maglia Vinyl**  
100% Vinyl



**Simil Ecoleder Aurea**  
72% PVC, 3% PU  
25% Katoen





Een ruimte waar mensen elkaar ontmoeten en gasten worden ontvangen, zo'n ruimte vraagt om een vriendelijke en functionele inrichting.









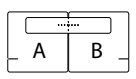

Lido, ontworpen door Fiorenze Dorigo, bestaat uit minimalistische elementen waarmee u de perfecte modulaire oplossing creëert voor uw wachtruimte.

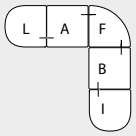
Verschillende vormen zitmodules, die kunnen worden gecombineerd met rugleuning, houten tafeltjes en open kastunits tot een praktisch geheel. Opvallend is de subtiele inkeping die met een ritssluiting wordt ontsloten en waar de accessoires simpelweg worden ingestoken.

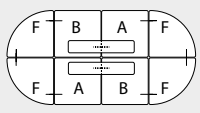
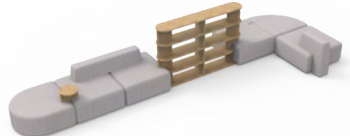
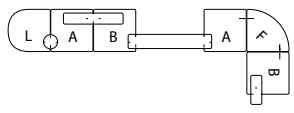
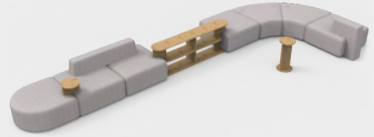
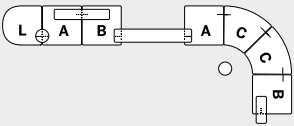

Dorigo Design  
**sitland**

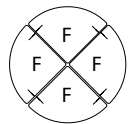
Creëer uw ideale opstelling, hieronder enkele voorbeelden

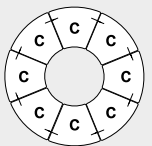
Model			b x d x h (cm)
		Lido 2x pouf met rug	90 x 110 x 71h
		Lido lage hoekopstelling	270 x 270 x 41h
		Lido eiland 1	510 x 160 x 41h
		Lido eiland 2	360 x 180 x 71h
		Lido eiland 3	608 x 200 x 116h
		Lido eiland 4	608 x 245 x 71h
		Lido cirkel klein	rond 180 x 41h
		Lido cirkel groot	rond 325 x 41h

Stoffering



ME-CH-ST-MF-MW-SY  
WI-FT-RM-HE-FD-S1



SC



-



# ASTRO TWIST



Quadrifoglio Group

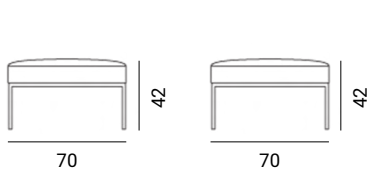

Astro poef

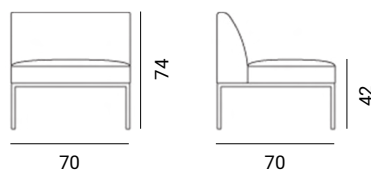

Astro zitje recht

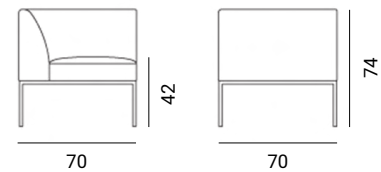

Astro zitje hoek

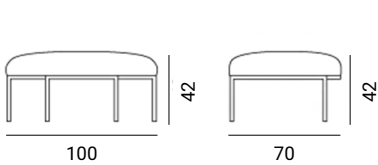

Astro poef gebogen

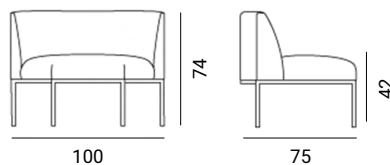

Astro zitje concaaf, gebogen binnen

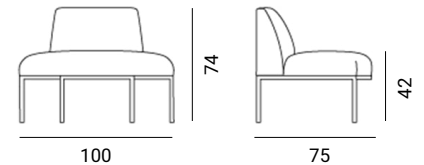

Astro zitje convex, gebogen buiten



Astro tafel vierkant

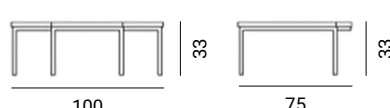

Astro tafel gebogen





Maak uw ontvangstruimte extra aantrekkelijk met de praktische Astro modules van het Italiaanse Quadrifoglio. Keuze uit vierkant of gebogen zitelementen uitgevoerd in comfortabel en vormvast koudschuim op duurzaam berken multiplex met een metalen frame. Hier en daar een bijpassend tafeltje en de ruimte is klaar om uw gasten te verwelkomen.

Metaalkleuren

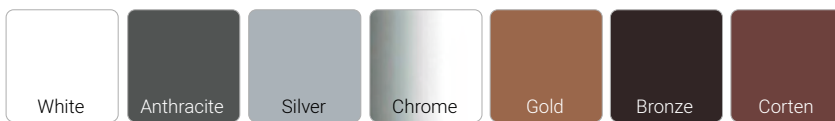

Melamine tafelblad

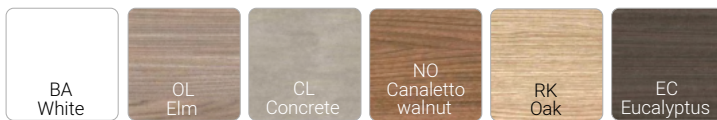

Mat lak kleuren



Stoffering

 B01-C01-C05-D02-D03  
E01-D04-E02-E03-E04  
I01-I02-M01-M02-M03

 B03 - D06

 P01





Bovenzijde armleuning wordt gestoffeerd in gelijke kleur als de sofa. Optioneel in B03 of P01 bekleed.

Optionele draaibare tafel met 12mm gelakt mdf topblad in shadow grey.

Optionele stroom aansluiting met 1x stroom en 2x USB lader.

Onderstel standaard uitgevoerd in antraciet of chroom. Optioneel in corten, bronze of gold.

Tafelblad uitgevoerd in 6 melamine bladkleuren.

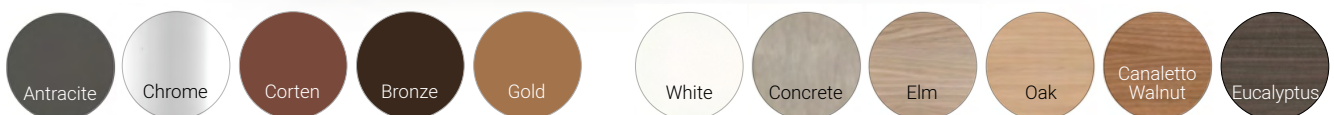



LEVERTIJD



GARANTIE



CONFIGUREERBAAR



MONTAGE

Met Avana maakt u de meest uiteenlopende creatieve opstellingen waarbij zitjes afgewisseld worden met tafels en poefjes. Hierdoor zijn de mogelijkheden eindeloos! Creëer uw Avana met deze ruime keus aan modellen, stoffering en opties. Avana is leverbaar in de maten small, large en extra large.

### Enkele voorbeeld modellen

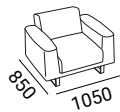

Avana small met armleuningen

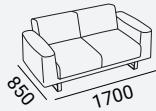

Avana large met armleuningen

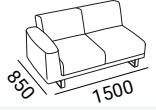

Avana large met armleuning R

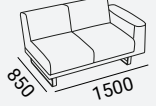

Avana large met armleuning L

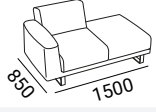

Avana large sofa-poef met armleuning R

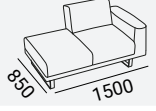

Avana large sofa-poef met armleuning L

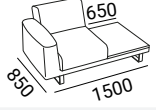

Avana large sofa-tafel met armleuning R

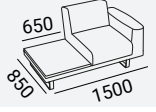

Avana large sofa-tafel met armleuning L

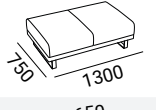

Avana large poef

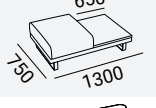

Avana large poef-tafel

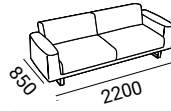

Extra large met armleuningen

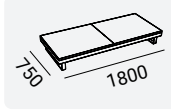

Extra large tafel

### Opties



ArMLEuning met bovenzijde afwijkend



Draaibaar tafeltje in shadow grey gelakt mdf

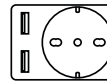

1x stroom 220V  
2x USB lader



Standaard in antraciet of chroom.  
Optioneel in corten, bronze of gold

### Stoffering



B01-C01-C05-D02-D03-E01-D04-E02  
E03-E04-I01-I02-M01-M02-M03



B03 - D06



P01





Dodo maakt zitten net even anders. Deze lichtgewicht poef zit fantastisch en kan geleverd worden in 3 modellen. Dodo is leverbaar in diverse modellen en kan desgewenst in duo-toon stoffering worden uitgevoerd.  
Kies optioneel voor een handige draaghendel in fraai leder of draaghendel in dezelfde kleur/stof van zitting.



Dodo

**Model**

Dodo poef 45h (43 cm rond)

Dodo poef 61h (43 cm rond)

Dodo poef 40h (80 cm rond)

**Stoffering voor zowel Dodo als Joy**BN - ST - RG - MF - MW - SY - CS  
WI - FT - RM - RW - HE - ME - CH

SC

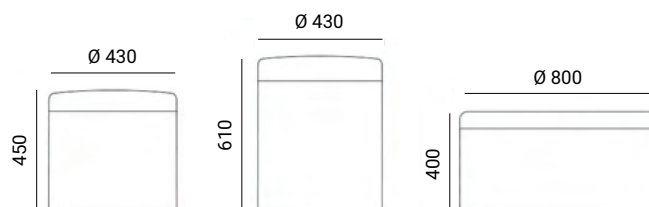

-

**Model**

Joy 50h verrijdbaar

Joy 60h verrijdbaar

Ergonomisch, comfortabel en multi-inzetbaar, dat is Joy! Kies de verrijdbare Joy of voor de versie met verzwaarde bolle voet zodat u altijd in beweging blijft en dat is uiteraard erg goed voor de rug. Joy is leverbaar in 2 hoogtes en kan worden uitgevoerd in diverse stofsoorten en kleuren. Kies voor een duo-toon uitvoering of de lederen draaghendel om uw Joy helemaal af te maken.



Joy

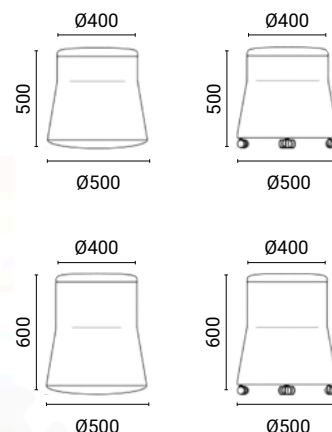



reddot winner 2023  
best of the best

De unieke vormgeving van de Moon, ontworpen door Serena Papait, herschrijft het concept van een ergonomische en natuurlijke zithouding. Een oneindig ontwerp, uitgevoerd in polypropyleen versterkt met fiberglass, en voorzien van gestoffeerde kussens in diverse stoffen en kleuren.



### Framekleuren



### Stoffering

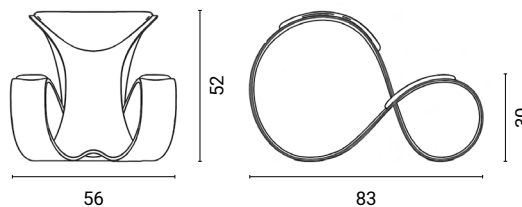



Cleopas, ontworpen door Trevor Holland & Brado, biedt een combinatie van ultiem comfort met ongekend Italiaans vakmanschap. Leverbaar met hoge of lage rugleuning, voorzien van vormvaste koudschuim kussens die u het gevoel geven van zitten op een wolk.

De fraaie schaal met decoratief rasterpatroon is vervaardigd uit gerecycled polypropeen en mogelijk in lakkleur of te bekleden met stof of eco-leder, geheel naar uw wens en smaak.

Maak uw Cleopas compleet met het optionele tafeltje of de elegante bijpassende hocker.





Kuip en metaalkleuren

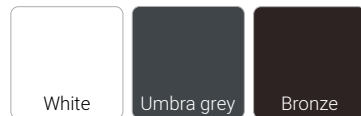

Stoffering



B01-C01-C05-D02-D03-E01  
D04-E02-E03-E04-I01-I02  
M01-M02-M03



B03-D06



P01

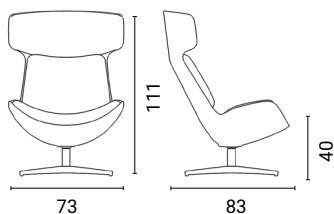

Cleopas high back

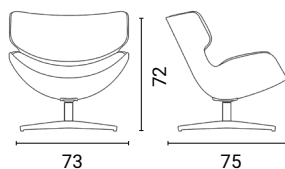

Cleopas low back

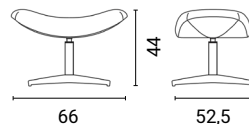

Cleopas hocker





### City Lounge modellen



City Lounge high back incl. hoofdsteun  
 -4-teens metaal polish alu of black  
 -4-poots metaal anthracite, gold, bronze of corten  
 -4-poots hout

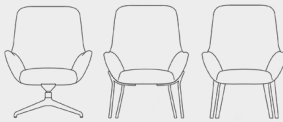

City Lounge high back  
 -4-teens metaal polish alu of black  
 -4-poots metaal anthracite, gold, bronze of corten  
 -4-poots hout



City Lounge medium back  
 -4-teens metaal polish alu of black  
 -4-poots metaal anthracite, gold, bronze of corten  
 -4-poots hout

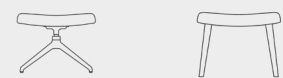

City Lounge hocker  
 -4-teens metaal polish alu of black  
 -4-poots hout

### Optie City Lounge

Neigmechaniek tbv 4-teens metaal

### Metaalkleuren



### Houtkleuren



City Lounge, oogstrelend comfort voor uw inrichting. Lounge stoel in diverse afmetingen met fraaie onderstellen in hout en metaal.

### Stoffering



B01 - C01 - C05 - D02  
 D03 - D04 - E01 - E02  
 E03 - E04 - I01 - I02  
 M01 - M02 - M03



B03 - D06



P01



City Lounge hocker en high back incl. hoofdsteun

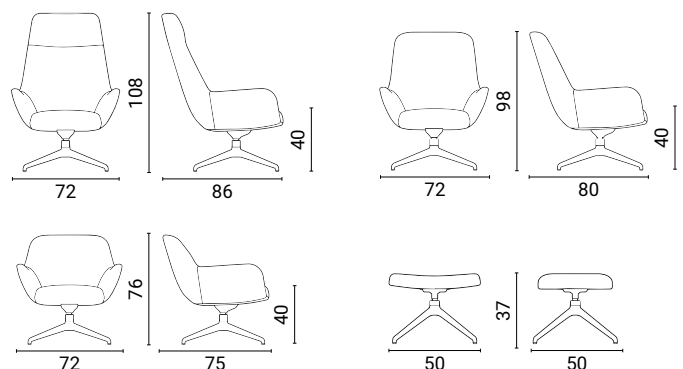



# CITY DÉCO LOUNGE

4-6  
weken  
LEVERTIJD

3  
GARANTIE

33

Ontvangen



City Déco Lounge is een luxe variant met handgemaakte bekleding waardoor een exclusief gedrapeerd effect ontstaat. De elegante Déco is leverbaar met metalen of houten 4-poots onderstel. Perfect passend in uw hedendaagse kantoor.

## Stoffering



D02 - D03 - D04 - E01  
E02 - E03 - E04 - I01



-



-

## Metaalkleuren



## Houtkleuren

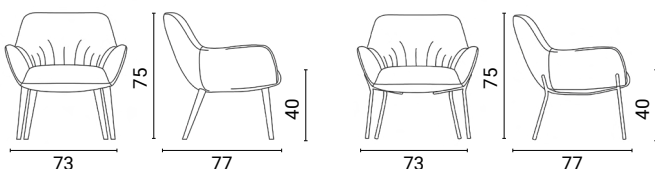

City Déco Lounge hout

City Déco Lounge metaal



**Quadrifoglio Group**



Our  
sustainable  
approach  
to design

Milos bestaat uit een ruime collectie stoelen met een elegante vormgeving en duurzame materialen. Voor elke functie en ruimte een passend model en te combineren met de fraaie Milos tafels. Milos en de Milos lounge voor de hybride kantoor-inrichting, laat uw mensen duurzaam en comfortabel zitten.

**sitland**  
Design by Dorigo

**Model Milos lounge**



Milos Lounge 4-poots hout\*  
Frame beuken naturel of beuken zwart



Milos Lounge 4-poots metaal  
Frame zwart of wit



Milos Lounge draaibaar 4-spaaks  
Frame zwart of chroom

**Stoffering**



ME - RG - MF - MW - CS - SY - FT - WI  
RM - RW - HE - FD - S1 - SE - S4 - CH



NX - SC



PA



\* Optioneel ook met armleggers te verkrijgen

**Houtkleuren**



**Frame kleuren metaal**

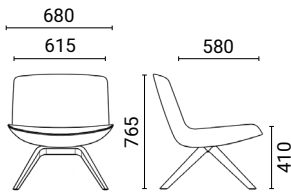

Milos Lounge 4-poots  
hout

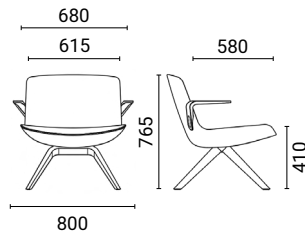

Milos Lounge 4-poots  
hout met armleuning

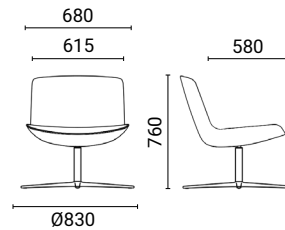

Milos Lounge draaibaar  
4-spaaks

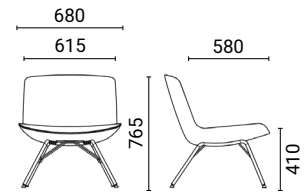

Milos Lounge 4-poots  
metaal

**Model Milos tafel**



Rest tafel 69 rond 35h  
Blad beuken naturel 18mm en frame 3-poots beukenhout  
Blad Fenix zwart 10mm en frame 3-poots beukenhout zwart



Rest tafel 55 rond 50h  
Blad beuken naturel 18mm en frame 3-poots beukenhout  
Blad Fenix zwart 10mm en frame 3-poots beukenhout zwart



Bistrot tafel 69 rond 35h  
Blad beuken naturel 18mm en frame 3-poots metaal  
Blad Fenix zwart 10mm en frame 3-poots metaal  
Blad HPL wit 10mm en frame 3-poots metaal



Bistrot tafel 69 rond 74h  
Blad beuken naturel 18mm en frame 3-poots metaal  
Blad Fenix zwart 10mm en frame 3-poots metaal  
Blad HPL wit 10mm en frame 3-poots metaal

**Rest/Bistrot houtkleuren**

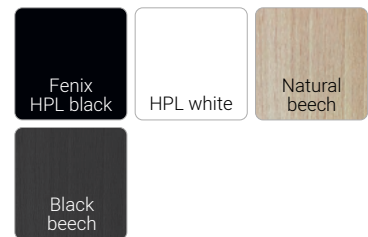

**Bistrot metaalkleuren**



Milos Rest

Milos Bistrot





Ado kenmerkt zich door zijn ranke stalen frame met strakke houten armleggers.  
Leverbaar in 1- of 2-zits met bijpassende tafel.

**Model**

Ado 1-zits in white of shadow grey

Ado 2-zits in white of shadow grey

Meerprijs armleuning in kleur Anthracite varnish  
Meerprijs frame in gold, bronzee en corten

**Stoffering**



B01-C01-C05-D02-D03-D04-E01  
E02-E03-E04-I01-I02-M01-M02-M03



B03-D06



P01

**Massief houten armleuningen**



**Metalen frame**

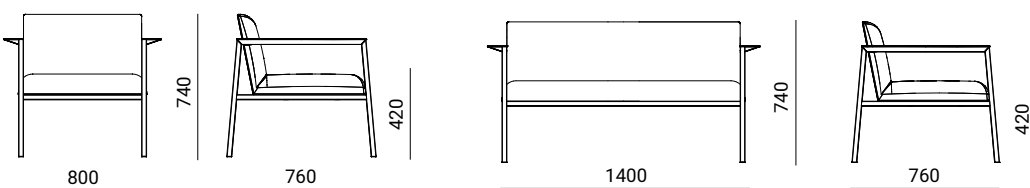

**Model**

Ado tafel

**Melamine tafelblad**

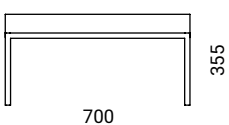
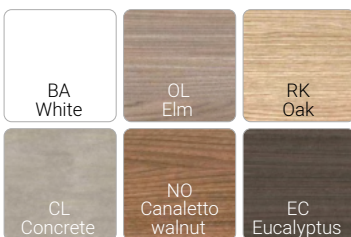





De Canapé serie is door haar hoge en dikke kussens een perfecte combinatie van comfort en design. Leverbaar als basisversie of met stiksels (GL) in 3 maatvoeringen.

Optioneel kan Canapé worden uitgevoerd in duo-toon (binnen dezelfde stofgroep/soort)

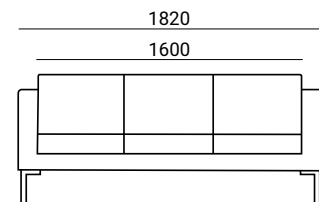
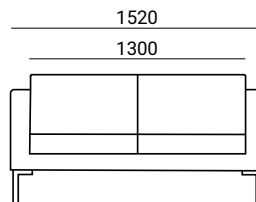
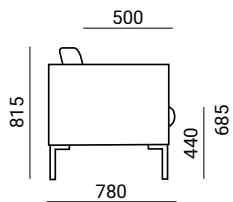
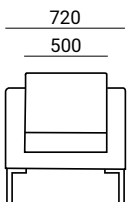

#### Model

- Canapé 1-zits
- Canapé GL 1-zits
- Canapé 2-zits
- Canapé GL 2-zits
- Canapé 3-zits
- Canapé GL 3-zits

#### Stoffering



AB - ST - RG - MF - MW - CS  
SY - RM - HE - FD - S1



NX - SC



SX+NX - PA - TS



Duo-toon stoffering +10%



Cell is ontworpen door Firenze Dorigo en bestaat uit een collectie zitelementen in diverse fraaie uitvoeringen. Kies voor de hoge versie met Cell 128 of de elegante lage versies met Cell 72 en Cell 75. De afwerking is van tophiveau met een kuip in geïnjecteerd koudschuim en een keuze uit de mooiste meubelstoffen. Kwaliteit en comfort zoals u van Sitland kunt verwachten.

**sitland**





Cell 128 is een opvallende verschijning in uw interieur. Een combi van comfort en akoestiek met haar fraaie hoge rug en dikke koudschuim zitting. Met de Cell Space koppelwand maakt u van de Cell 128 gesloten een functionele akoestische 2 of 4-zits spreekruimte. Voeg nuttige accessoires toe om de Cell Space compleet te maken.

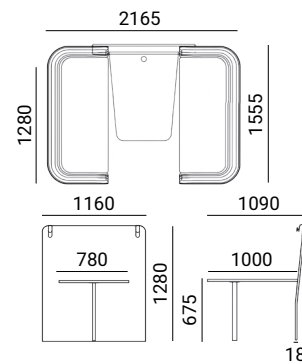
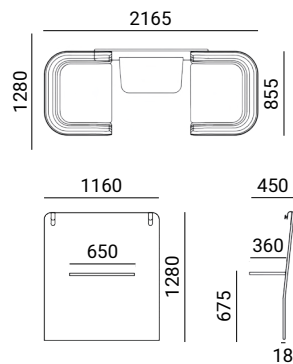
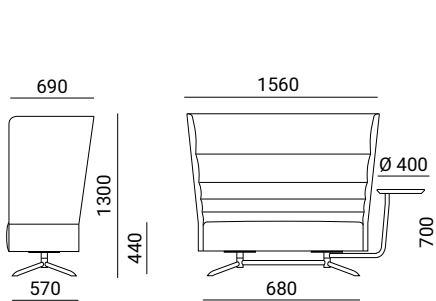

## Model



Cell 128 1-zits gesloten



Cell 128 1-zits draaibaar ronde voet zwart of wit\*



Cell 128 1-zits draaibaar 4-teens zwart of wit\*



Cell 128 1-zits draaibaar 4-teens beuken naturel\*

## Model



Cell 128 sofa gesloten



Cell 128 sofa 4-teens metaal zwart of wit\*  
Cell 128 sofa 4-teens beuken naturel\*

Stoffering zie pagina 42  
Meerprijs duo-toon +10%



Cell Space koppelstuk met kleine tafel  
(alleen op de gesloten versie)



Cell Space koppelstuk met grote tafel  
(alleen op de gesloten versie)

\* Optie draaibare tafel in mdf lak zwart, wit of massief hout naturel



Cell 72 combineert zijn royale en comfortabele zitkussen met een elegante lage kuip. Met verschillende onderstellen mogelijk.

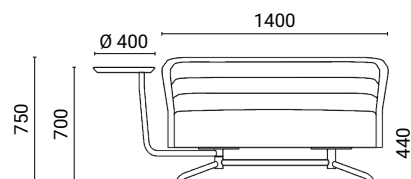
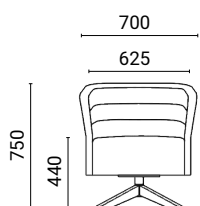
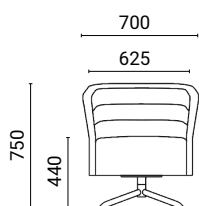
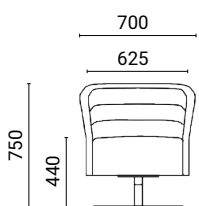

### Model



Cell 72 draaibaar  
ronde voet zwart of wit



Cell 72 draaibaar  
4-teens zwart of wit



Cell 72 draaibaar  
4-teens beuken naturel

### Model



Cell 72 sofa 4-teens metaal zwart of wit



Cell 72 sofa 4-teens beuken naturel

Meerprijs duo-toon +10%

### Stoffering



AL - ME - CH - ST - RG - MF - MW  
CS - SY - YO - FT - RM - HE - FD - S1



SC17 - SC18 - SC24



-

### Opties

Cell kussen 40x40, 50x50, 30x50, 60x45cm

Draaibare tafel in mdf lak zwart,  
wit of massief hout naturel

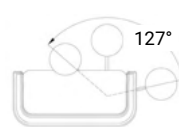

# CELL 75



LEVERTIJD



GARANTIE



CIRCULAIR



AKOESTIEK

43

Ontvangen

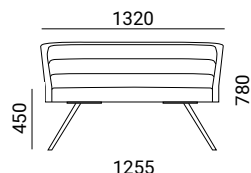
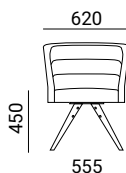
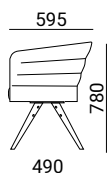

Cell 75 staat wat hoger op haar pootjes en heeft een normale zithoogte. Geniet van de comfortabele zitting in vormvast koudschuim en de fraai vormgegeven kuip.

## Model



Cell 75 4-poots beuken naturel

## Model



Cell 75 sofa 4-poots beuken naturel

## Optie

Cell kussen 40x40, 50x50, 30x50, 60x45cm

Meerprijs duo-toon +10%

## Stoffering



AL - ME - CH - ST - RG - MF - MW  
CS - SY - YO - FT - RM - HE - FD - S1



SC17 - SC18 - SC24



sitland



De akoestische en modulaire Kameleon zorgt voor rust in iedere inrichting. Een discreet telefoontje of een meeting met de collega's of klant, het kan allemaal.

Door het modulaire ontwerp kan elke Kameleon worden omgebouwd zowel vanbinnen als vanbuiten. Elk model heeft automatische verlichting, luchtventilatie met ionisering en stroompunten met USB en data aansluitingen. Natuurlijk volledig naar wens samen te stellen middels de handige configurator.

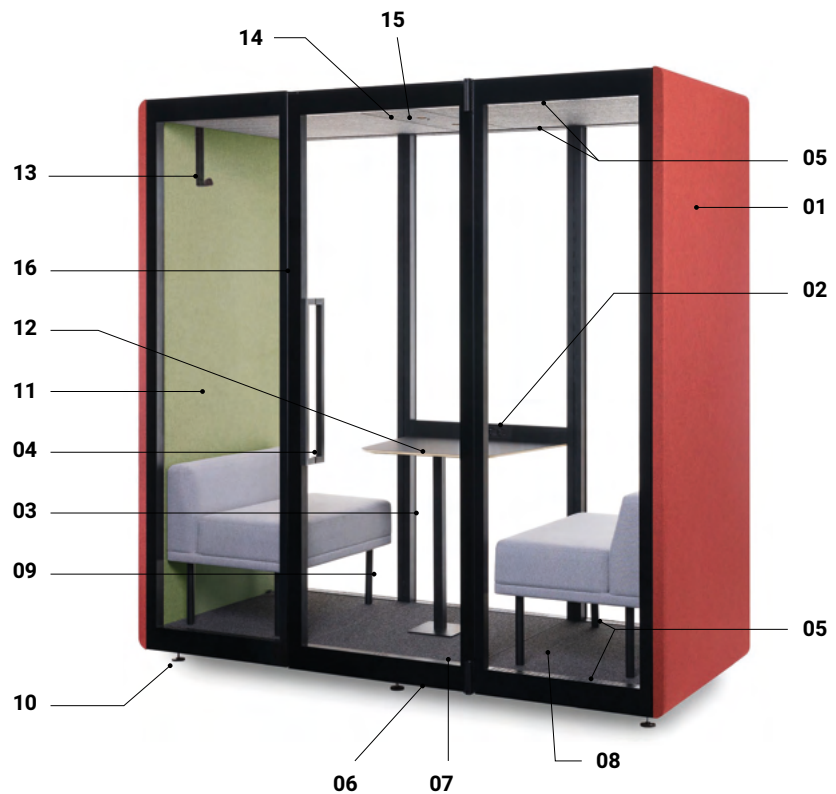

- 1. Uitwisselbaar exterieurpaneel**  
Kies uit diverse uitvoeringen, materialen en stofferingen.
- 2. Connectiviteit**  
Elk model heeft altijd een 220V stopcontact, USB charger en data aansluiting
- 3. Achterwand**  
Kies voor een akoestisch gelamineerd glaspaneel of een gesloten achterpaneel met verwisselbare interieurafwerking.
- 4. Links/rechts omkeerbare deuropening**  
Kies tijdens de installatie voor links of rechts draaiende openingsrichting.
- 5. Luchtinlaat & -uitlaat**  
Optimale luchtbehandeling: schone lucht wordt van onderaf naar binnen geblazen en van bovenaf weggezogen (ventilator is instelbaar).

- 6. Stroom- en ethernetuitgangen**  
Eenvoudige aansluiting van stroom en data. Kies voor aansluiting van bovenaf of onderaf.
- 7. Geïoniseerde en gezuiverde lucht**  
Geventileerde lucht wordt gefilterd en geïoniseerd. Binnen 68-100 sec. is de ruimte volledig ververs.
- 8. Zacht polyamide tapijt**  
Comfortabel en geluid isolerend.
- 9. Akoestisch gelamineerd glas**  
12 mm dik voor hoge geluid isolatie prestaties.
- 10. Stelpootjes + wielen**  
Uitgerust met wielen voor eenvoudige verplaatsing en van binnenuit verstelbare stevige stelpootjes.
- 11. Verwisselbaar interieurpanelen**  
Magnetische akoestische vilt binnenpanelen naar wens uitvoerbaar in diverse stofferingen.

- 12. Tafelbladen**  
Antimicrobieel HPL gelamineerd grenenhout.
- 13. Extra accessoires**  
Optioneel zijn er diverse accessoires leverbaar voor optimaal gebruiksgemak.
- 14. Plafond**  
Magnetische plafonddelen in donkergrijs 100% gerecycled PET-vilt.
- 15. Bewegingssensor**  
Bewegingsmelder activeert de ventilatie en sfeervolle verlichting. Na het verlaten van de ruimte blijft de ventilatie 15 min. aan.
- 16. Magnetisch vergrendelsysteem**  
Magnetische sluiting zorgt ervoor dat de deur altijd perfect gesloten blijft. De dubbele seals zorgen tevens voor een optimaal akoestisch resultaat.

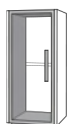

K1

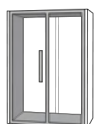

K1,5



K2



K4



K6



K6 Glass

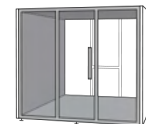

K7

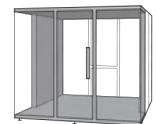

K7 Glass



LEVERTIJD



GARANTIE



CIRCULAIR



DUURZAAM



AKOESTIEK









CONFIGUREERBAAR



MONTAGE



Combineer de Askia Kameleon met functionele kasten en open Bridge elementen.

Kameleon modellen	Buitenmaten (bxdxh)	
 K1	107,5 x 100 x 230	1 persoon
 K1,5 K1,5+	152,5 x 100 x 230 152,5 x 120 x 230	1 persoon 1 persoon
 K2 K2+	227,5 x 100 x 230 227,5 x 120 x 230	2 personen 2-4 personen
 K4	227,5 x 200 x 230	4-6 personen
 K6 K6 Glass	227,5 x 300 x 230 227,5 x 300 x 230	6-8 personen 6-8 personen
 K7 K7 Glass	270,4 x 300 x 230 270,4 x 300 x 230	6-8 personen 6-8 personen





## T02

Tafel met metalen kolompoot en voetplaat (48x48cm) inclusief blad, hoogte 42 of 75cm.

Model	Code
T02 60 x 60 x 42h	CTPI604
T02 90 x 90 x 75h	CTPI907

### T02 melamine bladen

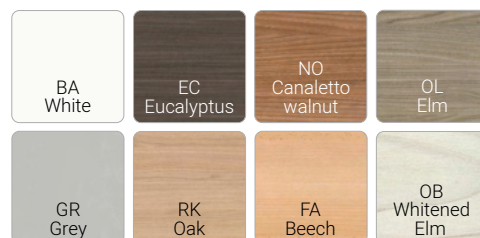

### T02 metalen framekleuren

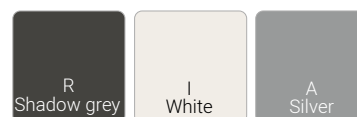

Quadrifoglio Group



## T05

Robuuste salontafel met 30mm dik blad van melamine in verstek. Ook leverbaar in 23 lakkleuren (zie pag 47).

Model	Code
T05 70 x 70 x 26h	CT45207
T05 100 x 100 x 26h	CT45210
T05 140 x 70 x 26h	CT45214

### T05 melamine

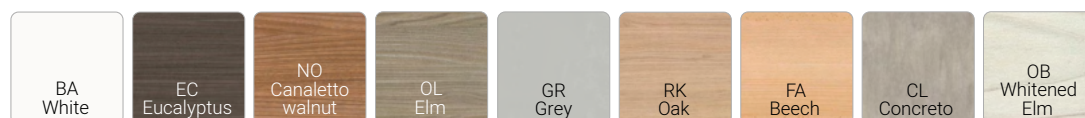



LEVERTIJD



GARANTIE



CIRCULAIR



MONTAGE

# Montreal

Elegante bijzettafels met metalen frame in diverse uitvoeringen voor uw ideale inrichting.

**Model 30h**

Montreal rond 99,8cm

Montreal vierkant 87,5 x 87,5cm

**Model 40h**

Montreal rond 58,8cm

Montreal vierkant 52 x 52cm

**Model 50h**

Montreal rond 45,8cm

Montreal vierkant 41 x 41cm

SCAN  
VOOR  
PRIJSLIJST

# Miami

Italiaans design met fraai metalen kokerframe en blad in diverse kleuren, materialen en maten.

**Model 30h**

Miami rond 99,8cm

Miami vierkant 87,5 x 87,5cm

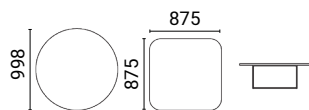
**Model 40h**

Miami rond 58,8cm

Miami vierkant 52 x 52cm

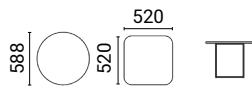
**Model 50h (sofa model)**

Miami rond 45,8cm

Miami vierkant 41 x 41cm

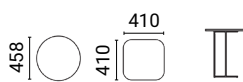
**Model 50h**

Miami rond 45,8cm

Miami vierkant 41 x 41cm

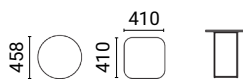
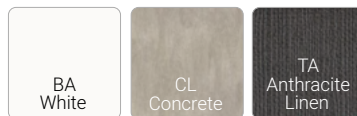
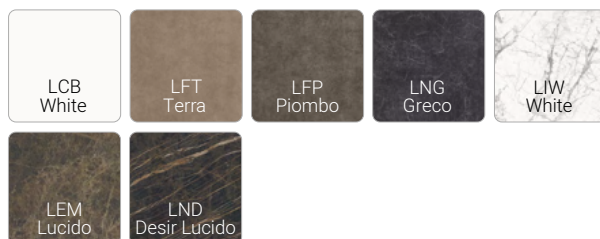
**Metaal frame****Melamine blad****Mat gelakt mdf blad****Porseleinen blad**







Een kantoor/werkruimte moet tegenwoordig niet alleen aan de strenge arbo-normen voldoen, maar ook aan tal van persoonlijke wensen die de gebruiker daar aan stelt. Een enkel rechthoekig bureau, een hoekbureau of een duowerkplek, hoogte instelbaar of verstelbaar voor flexibel gebruik en bijvoorbeeld stand werken.

Met onze modulaire systemen voldoen wij al jaren aan deze normen en wensen met producten die continu worden verbeterd en uitgebreid. Zowel voor de enkele werkplek als voor complete kantoortuinen. De keuzes om een werkplek samen te stellen zijn enorm. U kiest uit één van de bureauonderstellen het gewenste model: een T-poot, een 4-poots, A-poot of een wangpoot.

Vervolgens heeft u de keuze voor het ideale bureaublad qua afmeting, materiaal en kleur. Met deze keuzes kan de juiste opstelling gemaakt worden. Wij adviseren u daarna graag nog verder over praktische producten zoals ladenblokken, scheidingswanden, kabelmanagement etc. Kortom, de juiste oplossing voor uw werkplekken.



Het is algemeen bekend; een goede werkplek levert meer werkplezier op en verhoogt de productiviteit! Omdat er tegenwoordig enorm veel mogelijkheden zijn, nemen wij u graag mee om aan de hand van de juiste adviezen tot de beste keuze te komen. Van tafels met een vaste hoogte tot compleet uitgeruste zit-sta tafels, wij tonen u graag de oplossingen en zorgen dat u kunt genieten van een optimale werkplek.



#### Werkplekken 62-86cm bladhoogte.

In de serie metalen onderstellen bieden wij u diverse modulaire frames waarbij u zelf het gewenste type poot en tafelblad kunt kiezen. De onderstellen zijn hoogte instelbaar met eenvoudige schroefjes voor een bladhoogte van 62 tot 86cm (volgens Arbo). Het voordeel is een zeer stevig en praktisch bureau met telescopische kabelgoten voor uw kabelmanagement, en eindeloze configuraties die u zelf kunt maken met de talloze tafelbladen in diverse materialen en decors. Combineer uw werkplekken met de optionele vaste onderstellen voor mooi passende spreektafels.



#### Hoogte verstelbare werkplekken 71-119cm.

Bureaus die flexibel toegepast kunnen worden en waarvan de bladhoogte eenvoudig aan te passen is, bijvoorbeeld met een slinger of een slim kliksysteem. Een ideale oplossing voor gebruik van een werkplek door verschillende mensen. Neem plaats en stel het bureau op de gewenste hoogte voor uw ideale werkhouding. In het hoofdstuk Flex dynamisch werken bieden wij u tal van oplossingen voor de verstelbare werkplek.

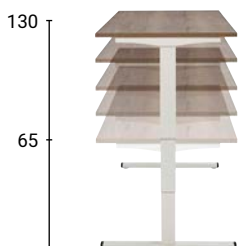

#### Zit-sta werkplekken 65-130cm.

Werken doen we nog steeds veel in een zittende houding, een zit-stabureau biedt u daarom de mogelijkheid om uw werk dynamisch uit te voeren met de vrijheid om de werkhogte eenvoudig en snel aan te passen van zitten naar staan. Onze elektrisch verstelbare bureaus hebben een hoogtebereik van 65 tot 130cm voor de ideale en gezonde werkplek! Kijk voor de vele mogelijkheden in modellen en maten vanaf pag. 78 bij Flex Dynamisch werken voor uw optimale kantoorinrichting.



### Single of duo-bench werkplekken.

Bureaus die je kunt combineren met bijpassende benchframes hebben een aantal belangrijke voordelen. Zo is een bench met een H-frame zeer praktisch om de vloer vrij te houden en schoon te maken, én kun je eenvoudig de scheidingswanden netjes op gelijke hoogte houden. Tussen de benchpoten is een optionele kabelbak ideaal om al uw kabels netjes weg te werken, of kies voor een dichte wangepoot aan de zijkant om uw kantoor een verzorgd en rustig aanzicht te geven.

### Welk bureaublad is voor u het meest geschikt?

Voor het juiste bureau- of tafelblad heeft u een ruime keuze, met voor elke toepassing een ideale oplossing. Hieronder stellen wij u kort de verschillende materialen voor



**Melamine bladen**, de standaard in de kantoorinrichting. De spaanplaat kern is voorzien van een decor waarover een krasvaste toplaag in diverse afwerkingen; van glad tot voelbare houtnerf. De randen worden afgewerkt met stootvast ABS. Melamine bladen zijn leverbaar in bijzonder veel kleuren en maatvoeringen. In dit boek treft u veel melamine aan, grotendeels uit voorraad leverbaar.



**HPL bladen**, waarbij HPL staat voor High Pressure Laminate. Bladen met HPL bestaan uit een kernplaat (zoals spaanplaat, mdf of multiplex) waarop een HPL decor wordt verlijmd. HPL is zeer krasvast en heeft een hogere puntbelasting dan melamine. Op aanvraag leverbaar in vele maatvoeringen en decors.

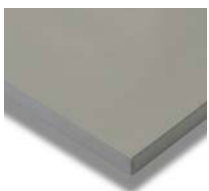

**Arpa Fenix HPL**, een variant met zeer praktische en unieke eigenschappen. Door de nanotech coating voelt het fluweelzacht aan en is het zelfs mogelijk om kleine krasjes met warmte te verwijderen (thermal healing). Anti reflectie, antibacterieel, zuurbestendig, bestand tegen vingerafdrukken en hygiënisch, kortom een prachtig materiaal in diverse kleuren en maten op aanvraag verkrijgbaar.



Bureau rechthoek			Onderstel bestaande uit	Aanbouw bureau		Onderstel bestaande uit
80 x 80			2 poten kabelgoot K	60 x 60		1 korte poot + kabelgoot kort + kabelgoot koppelstuk + 2 koppelplaatjes
120 x 80			2 poten kabelgoot L	60 x 80		1 korte poot + kabelgoot lang + kabelgoot koppelstuk + 2 koppelplaatjes
140 x 80			2 poten kabelgoot L	60 x 100		1 korte poot + kabelgoot lang + kabelgoot koppelstuk + 2 koppelplaatjes
160 x 80			2 poten kabelgoot L	60 x 120		1 korte poot + kabelgoot lang + kabelgoot koppelstuk + set bladragers
180 x 80			2 poten kabelgoot XL			
180 x 90			2 poten kabelgoot XL			
200 x 80			2 poten kabelgoot XL			
200 x 100			2 poten kabelgoot XL			



**Entrada onderstel**  
Voorraad kleuren

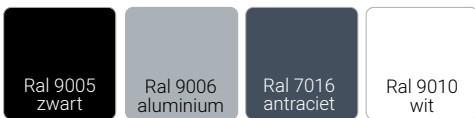

Entrada kort hoogte instelbaar

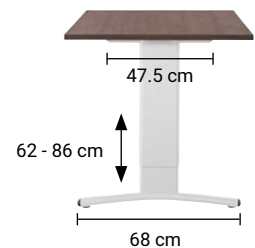

Entrada lang hoogte instelbaar



**Bladgroep 1**  
Melamine 25mm op voorraad

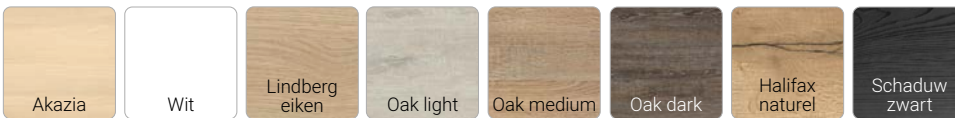

**Bladgroep 2**  
Melamine 25mm op bestelling

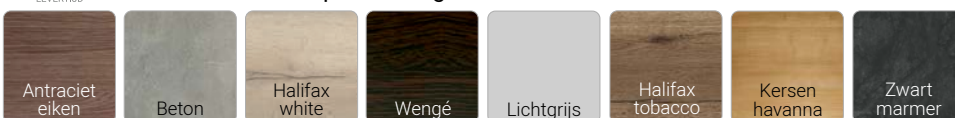

**Bladgroep 3**  
Quadrifoglio melamine 25mm op bestelling

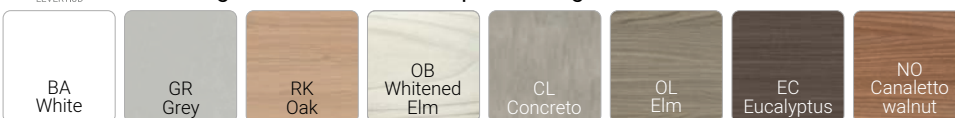

**Maatwerk**

Ook maatwerk op aanvraag in elke gewenste maatvoering op bestelling leverbaar, rekening houdend met maximale plaatmaten (levertijd 4-6 weken).



VOORRAAD



4-6  
weken

LEVERTIJD



GARANTIE



ARBO KEUR



CONFIGUREERBAAR



MONTAGE

In hoogte instelbaar van 62 tot 86 cm inclusief blad. Eindeloos te combineren met bladvormen, aanbouwmogelijkheden en accessoires.

Entrada is uit voorraad leverbaar in HI (hoogte instelbaar) in de ralkleuren 9005 zwart, 9006 aluminium, 7016 antraciet en 9010 wit.





Bureau rechthoek			Onderstel bestaande uit	Aanbouw bureau		Onderstel bestaande uit
80 x 80			2 poten 80 kabelgoot K	60 x 60		1 poot 60 + kabelgoot kort + kabelgoot koppelstuk + 2 koppelplaatjes
120 x 80			2 poten 80 kabelgoot L	60 x 80		1 poot 60 + kabelgoot lang + kabelgoot koppelstuk + 2 koppelplaatjes
140 x 80			2 poten 80 kabelgoot L	60 x 100		1 poot 60 + kabelgoot lang + kabelgoot koppelstuk + 2 koppelplaatjes
160 x 80			2 poten 80 kabelgoot L	60 x 120		1 poot 60 + kabelgoot lang + kabelgoot koppelstuk + set bladdragers
180 x 80			2 poten 80 kabelgoot XL			
180 x 90			2 poten 90 kabelgoot XL			
200 x 80			2 poten 80 kabelgoot XL			
200 x 100			2 poten 100 kabelgoot XL			



VOORRAAD

### Arca onderstel Voorraad kleuren



VOORRAAD

### Bladgroep 1 Melamine 25mm op voorraad

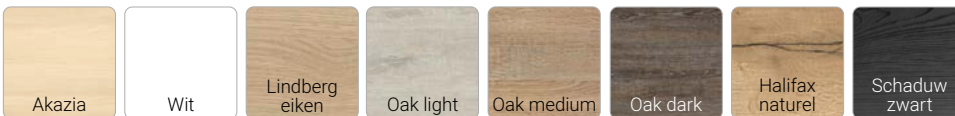

LEVERTIJD

### Bladgroep 2 Melamine 25mm op bestelling

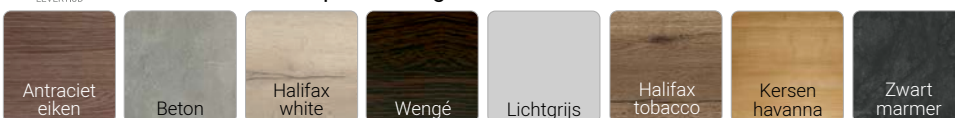

LEVERTIJD

### Bladgroep 3 Quadrifoglio melamine 25mm op bestelling

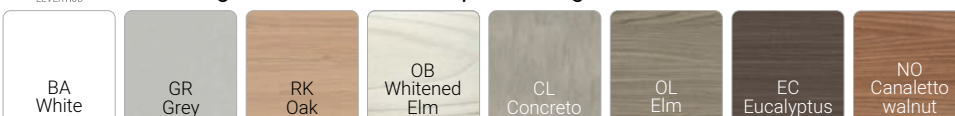

Arca is uit voorraad leverbaar in HI (hoogte instelbaar) en vaste hoogte in de ral kleuren 9005 zwart, 9006 aluminium en 9010 wit. Tevens leverbaar als modulaire Arca benchtafel voor meerdere werkplekken met één onderstel.

### Maatwerk



MAATWERK

Ook maatwerk op aanvraag in elke gewenste maatvoering op bestelling leverbaar, rekening houdend met maximale plaatmaten (levertijd 4-6 weken).



Bench-oplossingen		Onderstel bestaande uit
2 personen 120		2 poten 160 2 kabelgoten L
4 personen 120		2 poten 160 1 poot intermediair 4 kabelgoten L
6 personen 120		2 poten 160 2 poten intermediair 6 kabelgoten L
2 personen 140		2 poten 160 2 kabelgoten L
4 personen 140		2 poten 160 1 poot intermediair 4 kabelgoten L
6 personen 140		2 poten 160 2 poten intermediair 6 kabelgoten L
2 personen 160		2 poten 160 2 kabelgoten L
4 personen 160		2 poten 160 1 poot intermediair 4 kabelgoten L
6 personen 160		2 poten 160 2 poten intermediair 6 kabelgoten L
2 personen 180		2 poten 160 2 kabelgoten XL
4 personen 180		2 poten 160 1 poot intermediair 4 kabelgoten XL
6 personen 180		2 poten 160 2 poten intermediair 6 kabelgoten XL

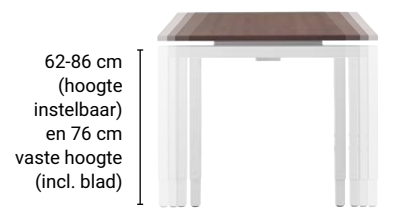

Arca 60, 80, 90 en 100

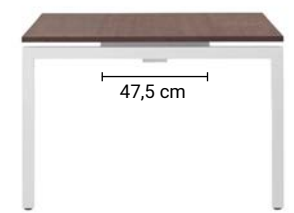

Arca 120  
vaste hoogte



Arca 160



Arca intermediair



Bureau rechthoek			Onderstel bestaande uit	Aanbouw bureau		Onderstel bestaande uit
80 x 80			2 poten 80 kabelgoot K	60 x 60		1 poot 60 + kabelgoot kort + kabelgoot koppelstuk + 2 koppelplaatjes
120 x 80			2 poten 80 kabelgoot L	60 x 80		1 poot 60 + kabelgoot lang + kabelgoot koppelstuk + 2 koppelplaatjes
140 x 80			2 poten 80 kabelgoot L	60 x 100		1 poot 60 + kabelgoot lang + kabelgoot koppelstuk + 2 koppelplaatjes
160 x 80			2 poten 80 kabelgoot L	60 x 120		1 poot 60 + kabelgoot lang + kabelgoot koppelstuk + set bladdragers
180 x 80			2 poten 80 kabelgoot XL			
180 x 90			2 poten 90 kabelgoot XL			
200 x 80			2 poten 80 kabelgoot XL			
200 x 100			2 poten 100 kabelgoot XL			



VOORRAAD

### Air2 onderstel Voorraad kleuren

Ral 9005  
zwartRal 9006  
aluminiumRal 9010  
wit

Elegante A-poot met een strak gelijnd  
60 x 30 mm kokerframe, zowel in vaste  
hoogte als in hoogte instelbare variant.

Air2 is uit voorraad leverbaar in ralkleur  
9005 zwart, 9006 aluminium en 9010 wit.



VOORRAAD

### Bladgroep 1 Melamine 25mm op voorraad

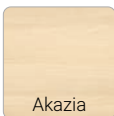

Akazia

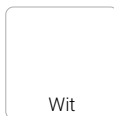

Wit

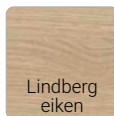
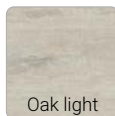
Lindberg  
eiken

Oak light



Oak medium

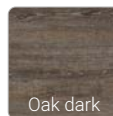

Oak dark

Halifax  
naturelSchaduw  
zwart

LEVERTIJD

### Bladgroep 2 Melamine 25mm op bestelling

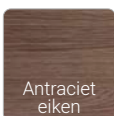
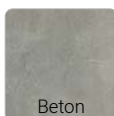
Antraciet  
eiken

Beton

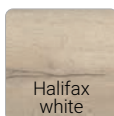
Halifax  
white

Wengé

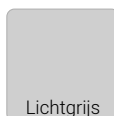

Lichtgrijs

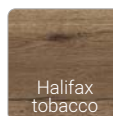
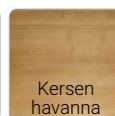
Halifax  
tobaccoKersen  
havannaZwart  
marmar

LEVERTIJD

### Bladgroep 3 Quadrifoglio melamine 25mm op bestelling

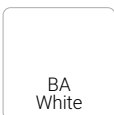
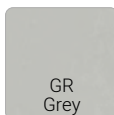
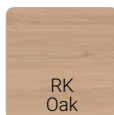
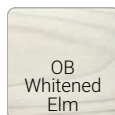
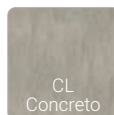
BA  
WhiteGR  
GreyRK  
OakOB  
Whitened  
ElmCL  
ConcretoOL  
ElmEC  
EucalyptusNO  
Canaletto  
walnut

MAATWERK

### Maatwerk

Ook maatwerk op  
aanvraag in elke gewenste  
maatvoering op bestelling  
leverbaar, rekening houdend  
met maximale plaatmaten  
(levertijd 4-6 weken).





VOORRAAD



LEVERTIJD



GARANTIE



ARBO KEUR



CONFIGUREERBAAR



MONTAGE

Bench-oplossingen		Onderstel bestaande uit
2 persoons 120		2 poten 160 2 kabelgoten L
4 persoons 120		2 poten 160 1 poot intermediair 4 kabelgoten L
6 persoons 120		2 poten 160 2 poten intermediair 6 kabelgoten L
2 persoons 140		2 poten 160 2 kabelgoten L
4 persoons 140		2 poten 160 1 poot intermediair 4 kabelgoten L
6 persoons 140		2 poten 160 2 poten intermediair 6 kabelgoten L
2 persoons 160		2 poten 160 2 kabelgoten L
4 persoons 160		2 poten 160 1 poot intermediair 4 kabelgoten L
6 persoons 160		2 poten 160 2 poten intermediair 6 kabelgoten L
2 persoons 180		2 poten 160 2 kabelgoten XL
4 persoons 180		2 poten 160 1 poot intermediair 4 kabelgoten XL
6 persoons 180		2 poten 160 2 poten intermediair 6 kabelgoten XL

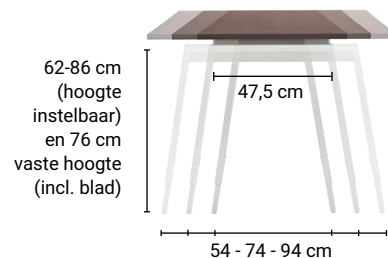

Air2 60, 80 en 100



Air2 160



Air2 160 intermediair



Het componenten assortiment kent een ruime keuze aan producten en biedt een veelzijdigheid aan mogelijkheden.

Combineer diverse onderstel types met praktische onderdelen waardoor elke uitdaging kan worden verwezenlijkt.

Voeg daarbij diverse accessoires toe voor de ideale werkplek. Alle producten zijn leverbaar in diverse ral kleuren. Voor mogelijkheden en prijzen zie pag. 60-61.



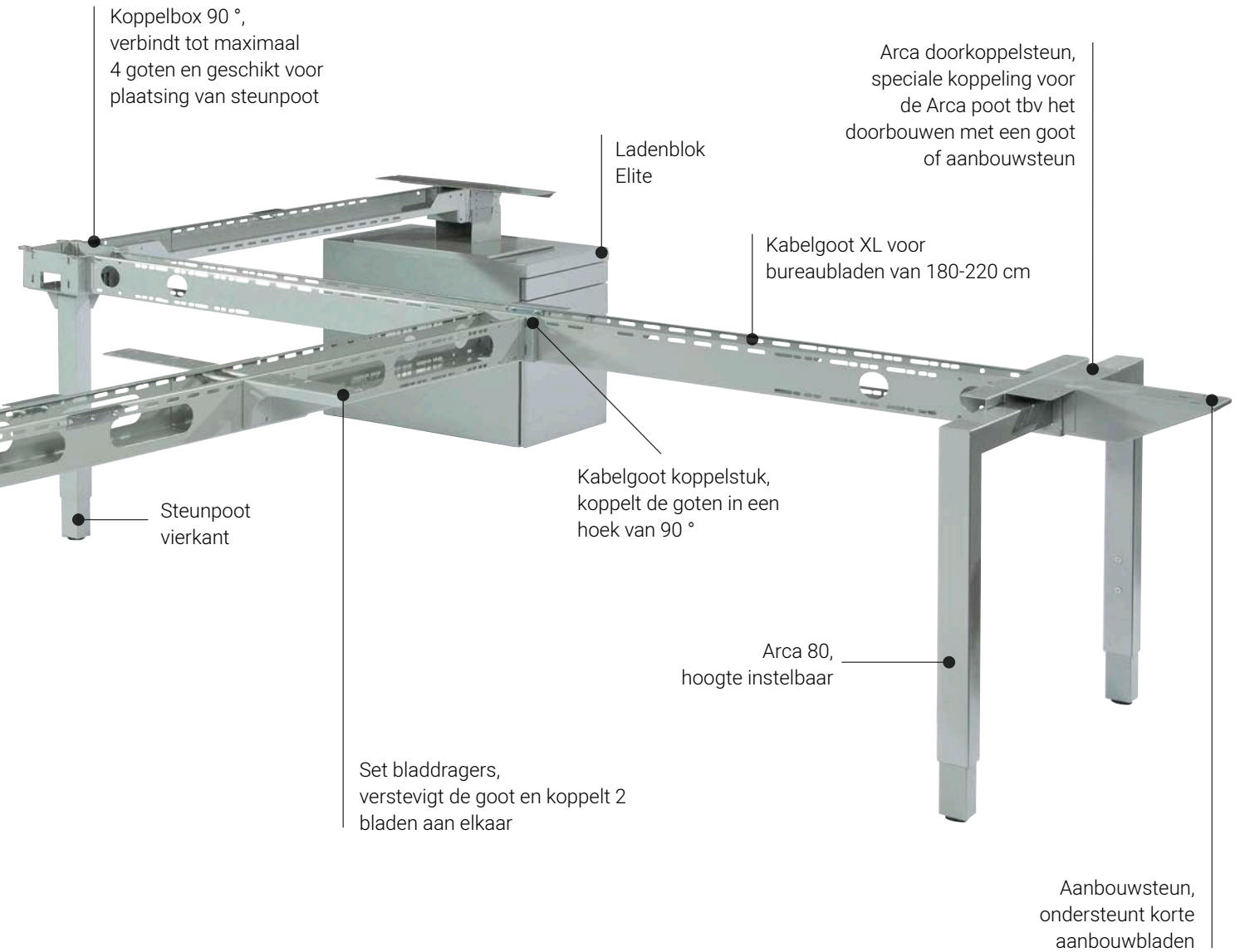



zw alu ant wit

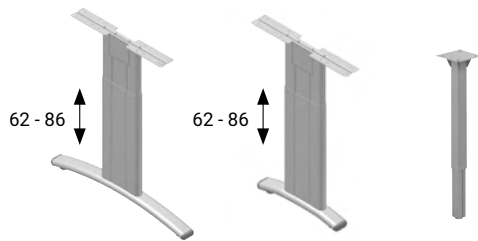

### Entrada losse poten HI (bladhoogte 62-86cm)

Entrada lang of kort

Steunpoot vierkant

zw alu wit

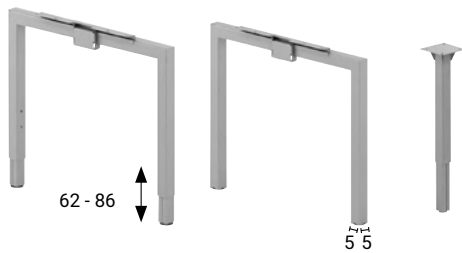

### Arca losse poten HI of vast (bladhoogte 62-86cm of vast 76cm)

Arca 60

Arca 80

Arca 90

Arca 100

Arca 120

Arca 160

Arca intermediair 113

Steunpoot vierkant

zw alu wit

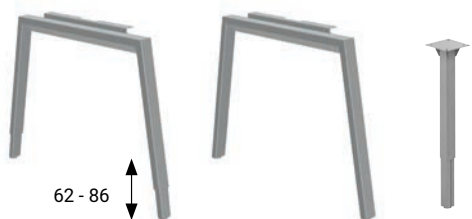

### Air2 losse poten HI of vast (bladhoogte 62-86cm of vast 76cm)

Air2 60

Air2 80

Air2 100

Air2 160

Air2 intermediair

Steunpoot vierkant

Hoogte aanduiding inclusief blad van 25mm





VOORRAAD



GARANTIE



CIRCULAIR



ARBO KEUR



CONFIGUREERBAAR



MONTAGE

zw alu wit

**Kabelgoten telescopisch**

Kort 70-110 cm  
Lang 120-180 cm  
Extra lang 180-220 cm  
XXL 220-260 cm

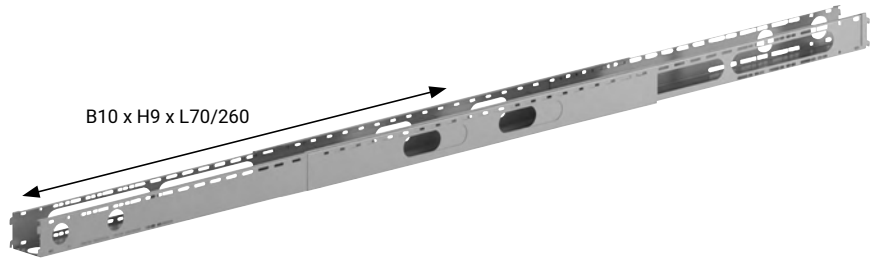

Maatvoering inclusief poten.

zw alu wit



15 x 15 x 9.5

**90° Koppelbox**

voor bevestiging op steunpoot, maakt doorkoppelen van kabelgoten mogelijk



13 x 9 x 15

**Kabelgoot koppelstuk**

verbindt kabelgoten haaks op elkaar



19 x 7.5 x 8.5 (x2)

**Set bladdragers**

versteviging voor het koppelen van bladen



33 x 75 x 9

**Arca doorkoppelsteun**

te monteren op Arca onderstel om kabelgoten door te koppelen



33 x 75 x 9

**Air2 doorkoppelsteun**

te monteren op Air2 onderstel om kabelgoten door te koppelen

zw alu wit



23 x 10 x 9

**Aanbouwsteun**

voor aanbouwbladen bij Entrada en Arca en Air2

zw



8 x 8 x 0.3

**Koppelplaatje**

alu



**U-profiel - 140 cm**

U-profiel voorkomt doorbuigen

zw alu ant wit (incl. beugels)

Zichtschot 120 cm

Zichtschot 160 cm

Zichtschot 180 cm

Losse set zichtschot beugels

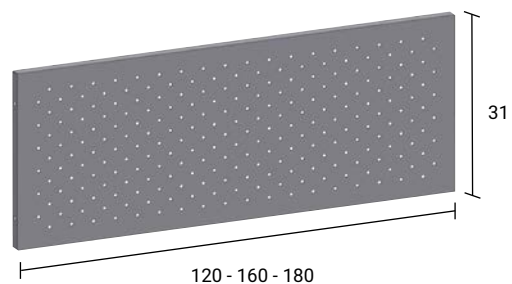



PL-1 persoonlijke lade voorzien van telescopische geleiders (100% uittrekbaar) en soft-close. De lade is afsluitbaar en voorzien van 2 kniksleutels. Buitenmaat 41x34,5x10cm en binnenmaat 35,5x28,5x5,5cm (bxdxh).

Direct te monteren onder het werkblad, ruimtebesparend en efficiënt! Tot maximaal 2 stuks boven elkaar te monteren.

#### PL-1 metaal kleuren



Model	h x b x d
PL-1	10 x 41.5 x 34.5 cm





VOORRAAD



GARANTIE



CIRCULAIR



MONTAGE

PL-S persoonlijke, compacte lade voorzien van telescopische geleiders (100% uittrekbaar). De lade is afsluitbaar en voorzien van 2 sleutels. Buitenmaat 30x31x5cm en binnenmaat 28x29,5x4cm (bxdxh). Zeer efficiënte lade, te monteren direct onder het werkblad.



PL-S is perfect te plaatsen onder de S-line serie met bladen van 80cm diep.

PL-S  
metaal kleuren

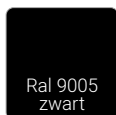

Ral 9005  
zwart



Ral 7045  
grijs

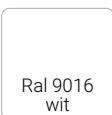

Ral 9016  
wit

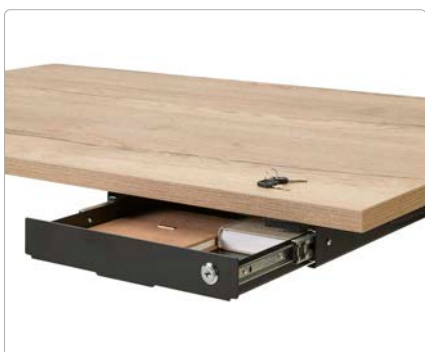



Neutral Plus 3+1



Neutral 2



Neutral Plus 2+1



Neutral 3



### Neutral en Neutral Plus ladenblok

De verrijdbare ladenblokken uit de Neutral serie kenmerken zich door haar optimale praktische eigenschappen. Neutral is leverbaar in 2 laden met hangmaplade of 3 laden versie, en is voorzien van een degelijk Meroni slot met 2 kniksleutels. De Neutral Plus heeft als extra een aparte ondiepe bovenlade met pennenbakje om al uw persoonlijke spullen netjes op te bergen.

Model	h (incl. wielen) x b x d
Neutral 2 verrijdbaar, hangmaplade* + 1x lade	53.5 x 42 x 58 cm
Neutral 3 verrijdbaar, 3x laden	53.5 x 42 x 58 cm
Neutral Plus 2+1 verrijdbaar, hangmaplade* + 1x lade + 1x pennenlade	53.5 x 42 x 58 cm
Neutral Plus 3+1 verrijdbaar, 3x laden + 1x pennenlade	53.5 x 42 x 58 cm

LET OP: Ral 7016 antraciet alleen bij Neutral 2 + 3, Ral 7022 shadow grey alleen bij Neutral Plus 2+1 en 3+1.

\* Standaard in de hangmaplade een losse dwarsstang tbv foliomappen (lade geschikt voor A4 mappen)

### Opties

- 1a. Diepteschetje tbv 60 diepe lade
- 1b. Recht ladenschotje tbv 42 breed (niet voor pennenlade)
2. Schuin ladenschotje tbv 42 breed (niet voor pennenlade)
3. Telescopisch pennenbakje tbv Neutral 2 en 3

### Topbladen

60 x 42 voor ladenblok



### Blad groep 1 Melamine op voorraad

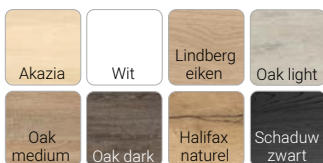

### Blad groep 2 Melamine op bestelling

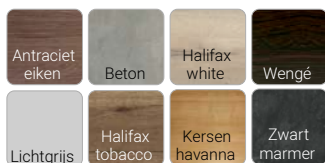

### Neutral Metaal kleuren



### Neutral Plus Metaal kleuren



Gemonteerd geleverd

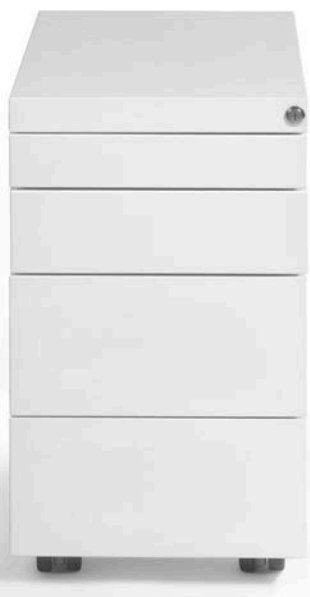

ELS 460



EL 360



EL 460

Model	h x b x d
ELS 460 smal verrijdbaar 3x lade - pennenlade	56,5 x 32 x 60 cm
EL 360 verrijdbaar hangmaplade - lade - pennenlade	56,5 x 42 x 60 cm
EL 460 verrijdbaar 3x lade - pennenlade	56,5 x 42 x 60 cm
EL 480 verrijdbaar 3x lade - pennenlade	56,5 x 42 x 80 cm

Elite verrijdbare metalen ladenblokken, voorzien van kleine rubberen wielen met rem. De pennenlade heeft standaard een pennenbakje, de overige lades zijn telescopisch uittrekbaar. Inclusief slot met dubbele kniksleutel.

### Topbladen

60 x 32	60 32
60 x 42	60 42
80 x 42	80 42



Gemonteerd  
geleverd



**Blad groep 1**  
Melamine op voorraad

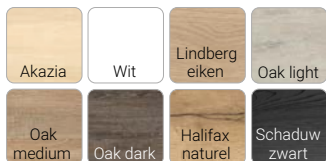

**Blad groep 2**  
Melamine op bestelling

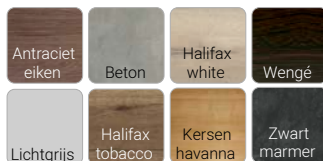

**Elite**  
Metaal kleuren



### Opties

- 1a. Diepteschetje tbv. 60 of 80 diepe lade
- 1b. Recht ladenschotje tbv. 42 breed
2. Schuin ladenschotje tbv. 42 breed
3. Telescopisch pennenbakje inbegrepen



1a/b



2



3

# Q4 LADENBLOKKEN



VOORRAAD



LEVERTIJD



GARANTIE



CIRCULAIR







MONTAGE

67

Merken

Q4 verrijdbare melamine ladenblokken zijn leverbaar in 8 kleuren en perfect passend bij de Q4 bureaubladen. De lades met uittrekbeveiliging zijn afsluitbaar en uitgevoerd in neutraal grijs melamine. Voorzien van 4 zwenkwielen, de hangmaplade heeft een extra wielje ter ondersteuning.



Model	b x d x h
 Gewone lade en hangmappenlade	42 x 56 x 58
 3x gewone lade	42 x 56 x 58
 Pennenlade, gewone lade, hangmappenlade	42 x 56 x 58,5
 Pennenlade en 3x gewone lade	42 x 56 x 58,5



## Opties

Softclose op de lades

Pennenbakje zwart PVC passend in lade

Metalen greepje Zen (p/st)

## Standaard ABS greepjes



Look silver (J)

Look white (JB)

Look shadow grey (JR)

## Optie metalen greepjes



Zen silver (Z)

Zen white (A)

Zen shadow grey (Q)

Zen chroom (Y)



LEVERTIJD

## Quadrifoglio melamine kleuren

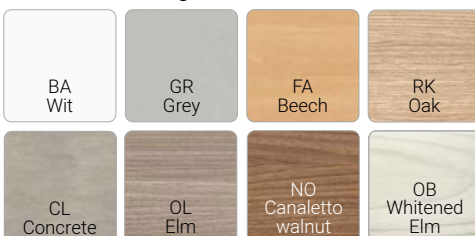

Quadrifoglio Group



Getoonde bureaustoel Diade Rock

De ranke T-poot kenmerkt Idea+ Tube en is als vaste hoogte óf in hoogte instelbare variant leverbaar. Een ruime keuze aan kleuren en mogelijkheden waardoor voor iedere ruimte een passende werkplek te realiseren is.

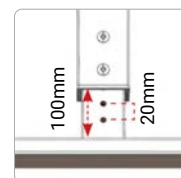
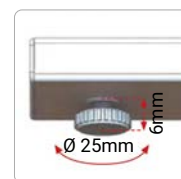
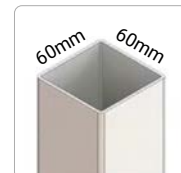

#### Kleuren metalen frame



#### Kleuren topbladen bureaus Idea+ Tube en Idea+ 01 (dikte 30mm)

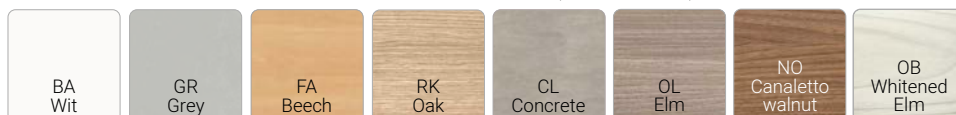

# IDEA+ 01

4-6  
weken

3  
GARANTIE

CIRCULAIR

MONTAGE

69

Merken

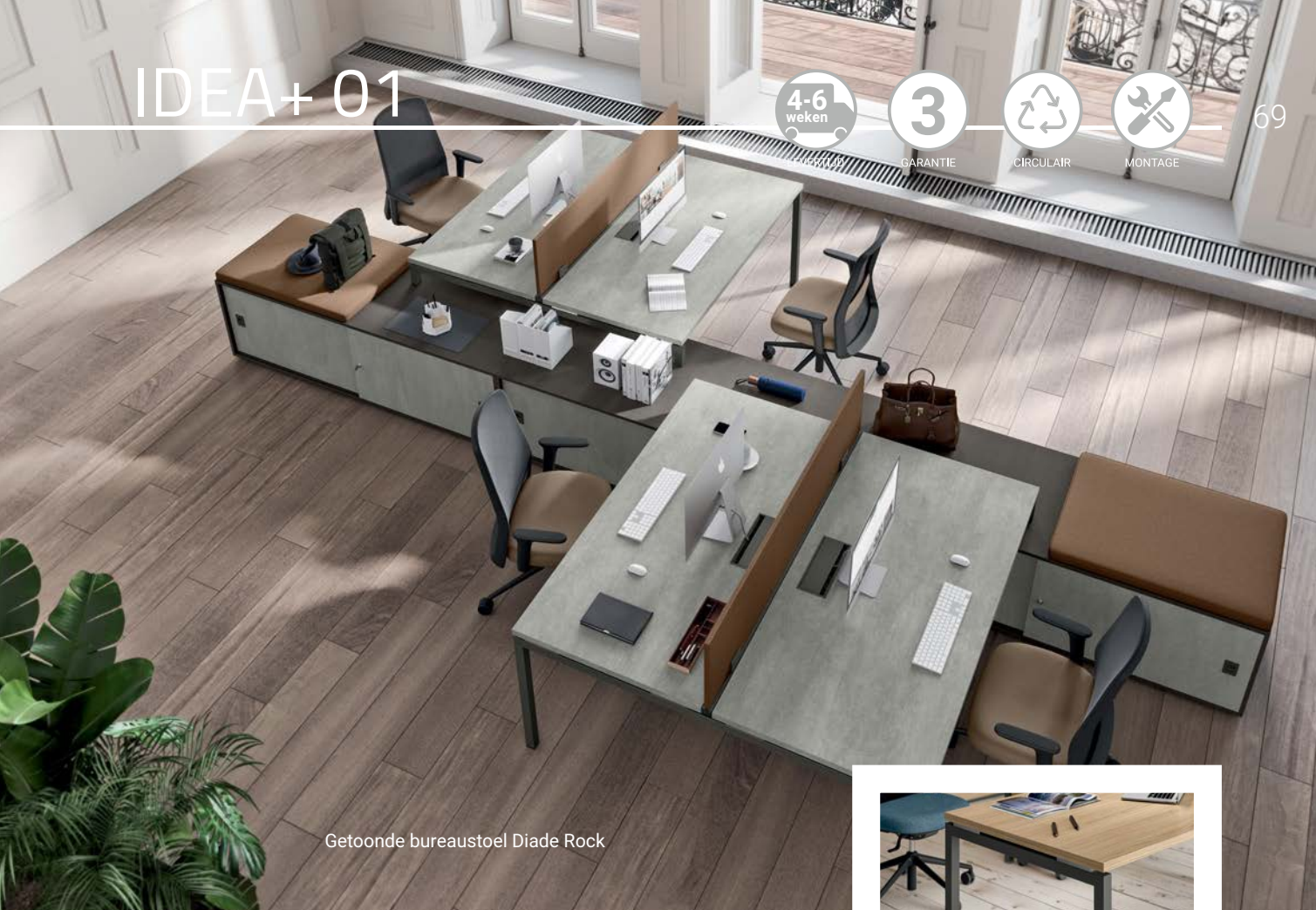

Getoonde bureaustoel Diade Rock



De stoere 4-poots werkplek, zowel in een vaste hoogte als hoogte instelbare versie leverbaar.  
De vele creatieve mogelijkheden maken Idea+ 01 tot een ideale oplossing voor elk interieur.

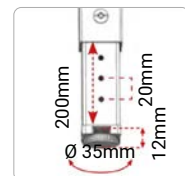



X4 van Quadrifoglio is zeer functioneel door zijn schuifbare werkblad waardoor kabels en stekkers snel binnen handbereik zijn. Kies voor het stoere metalen onderstel óf de luxe combinatie met de houten afwerking.

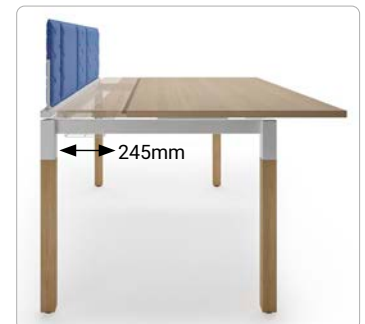

Schuifblad

#### Kleuren topbladen X4 (dikte 25mm)

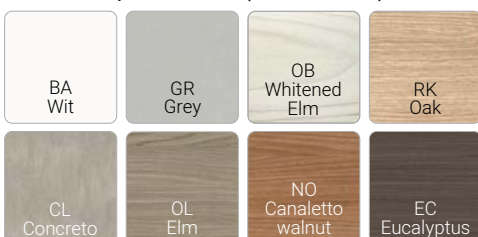

#### Kleuren metalen onderstel

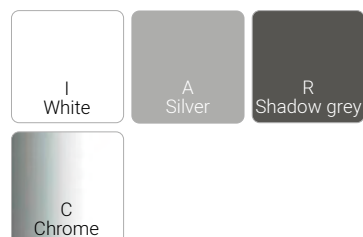

#### Kleur onderstel houten deel (icm metalen onderstel)

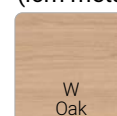



De Q4 scheidingswanden zijn leverbaar in diverse uitvoeringen en geschikt voor de series Idea+ Tube, Idea+ 01 en X4. Kies voor de optisch fraaie glazen of de akoestische gestoffeerde wanden met de gewenste klem of beugel. Voor elke wens de ideale oplossing.

Naast wanden biedt Quadrifoglio ook diverse kabelbakken en goten die met de eigen klemmen perfect te combineren zijn.



## Kleuren wanden melamine

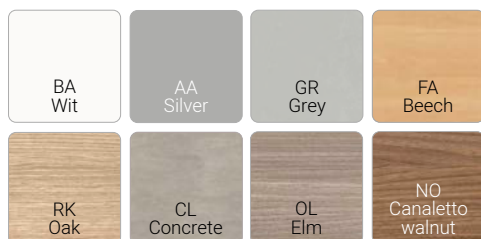

## Kleuren wanden stof



## Frame metaal kleuren

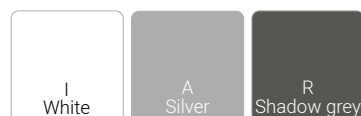





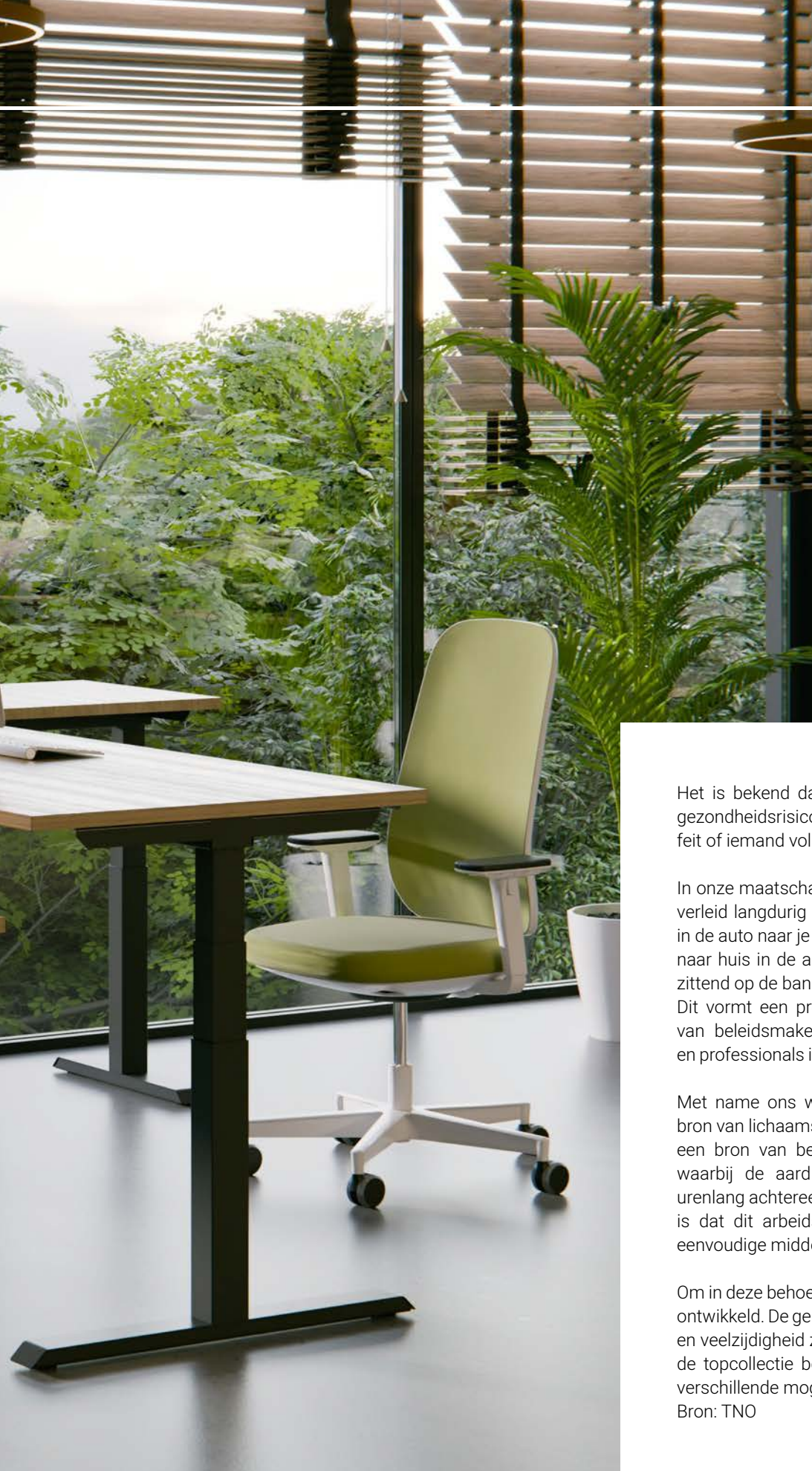

Het is bekend dat langdurig achtereen zitten gezondheidsrisico's kent, onafhankelijk van het feit of iemand voldoende sport of beweegt.

In onze maatschappij worden we steeds vaker verleid langdurig te zitten; je zit tijdens ontbijt, in de auto naar je werk, op het werk, weer terug naar huis in de auto, en vervolgens rusten we zittend op de bank uit na een dag hard werken. Dit vormt een probleem dat aandacht vraagt van beleidsmakers, werkgevers, werknemers en professionals in preventie, zorg en inrichting.

Met name ons werk, vroeger een belangrijke bron van lichaamsbeweging, is in vele sectoren een bron van bewegingsarmoede geworden, waarbij de aard van het werk ons dwingt urenlang achtereen te zitten. Het goede nieuws is dat dit arbeidsrisico mogelijk met relatief eenvoudige middelen beheersbaar wordt.

Om in deze behoefte te voorzien is de Flex serie ontwikkeld. De gebruiksvriendelijkheid, kwaliteit en veelzijdigheid zorgen ervoor dat deze lijn tot de topcollectie behoort. Blader verder om de verschillende mogelijkheden te bekijken.

Bron: TNO



## S-Light slinger

### Bestaande uit:

- 1 x S-Light slinger
- 1 x blad 160x80cm Lindberg Eiken

### Getoond:

- bureaustoel SW-1 met 4D armleggers
- ECO-screen 9 opzetwand met V-groef éénzijdig 160x40cm (incl. 2 klemmen)



**Gewicht capaciteit**  
70 kg



**Verstelbereik**  
71 - 119 cm



**Snelheid**  
12 mm/draai



VOORRAAD



LEVERTIJD



GARANTIE



ARBO KEUR



MONTAGE

S-Light slinger is in hoogte verstelbaar middels de handige opklapbare slinger van 71-119cm. Na gebruik klappt u de slinger eenvoudig in en bergt deze op in de houder onder het werkblad. Door het speciale mechaniek waarbij 1 omwenteling het blad 12mm in hoogte verstuelt, past u de hoogte razendsnel aan van zitten naar staan. Het frame is telescopisch in breedte instelbaar van 110 - 180cm en heeft een gewicht capaciteit van 70kg.



Slinger opklapbaar om netjes onder het blad op te bergen.



VOORRAAD

S-Light slinger onderstel  
Voorraad kleuren



VOORRAAD

Blad groep 1  
Melamine 25mm op voorraad

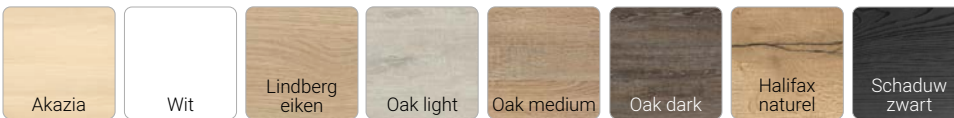

LEVERTIJD

Blad groep 2  
Melamine 25mm op bestelling

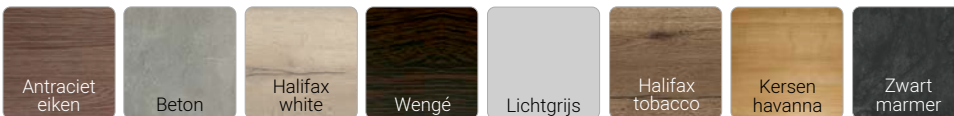

LEVERTIJD

Blad groep 3  
Quadrifoglio melamine 25mm op bestelling

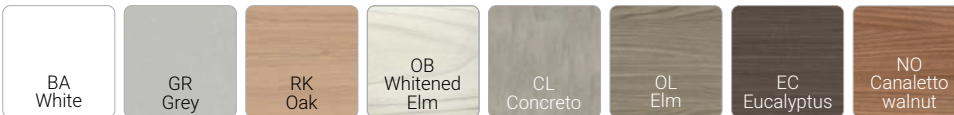

Maatwerk

Ook maatwerk op aanvraag in elke gewenste maatvoering op bestelling leverbaar, rekening houdend met maximale plaatmaten (levertijd 4-6 weken).



## Flex Raster 160x80

**Bestaande uit:**

1x Flex Raster 160x80 wit  
1x Blad 160x80cm NO Canaletto walnut

Getoonde bureaustoel: Oxygen



Hoogte aanduiding



Verstel het frame naar de gewenste hoogte en blokkeer het frame met de schuif.

Flex Raster met gebruiksvriendelijk raster systeem om uw werkblad handmatig in hoogte te verstellen van 65 tot 86cm.

Met de blokkeerschuif zet u eenvoudig het frame vast op de gewenste hoogte.

Op elke poot staat de hoogte netjes per 2 cm vermeld.



Model	Bladmaat
Flex Raster 120	120 x 80
Flex Raster 140	140 x 80
Flex Raster 160	160 x 80
Flex Raster 180	180 x 80
Flex Raster 180	180 x 90
Flex Raster 200	200 x 80
Flex Raster 200	200 x 100



Flex raster onderstel voorraad kleuren



Blad groep 1 Melamine 25mm op voorraad

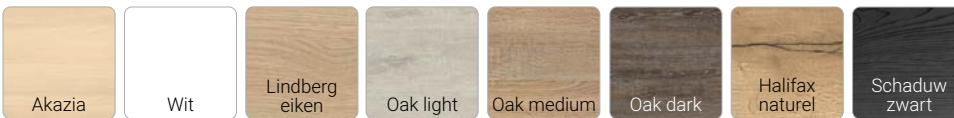

Blad groep 2 Melamine 25mm op bestelling

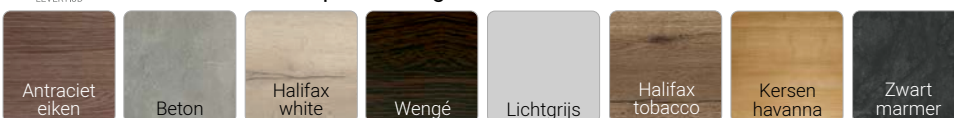

Blad groep 3 Quadrifoglio melamine 25mm op bestelling

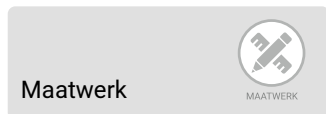
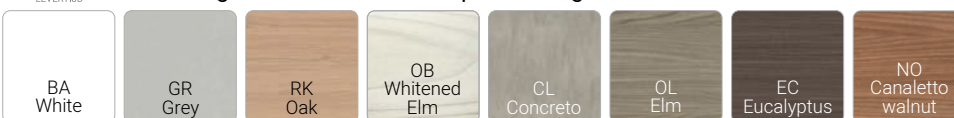

Maatwerk

Ook maatwerk op aanvraag in elke gewenste maatvoering op bestelling leverbaar, rekening houdend met maximale plaatmaten (levertijd 4-6 weken).

# S-LINE SINGLE & BENCH

S-Line, de nieuwste generatie elektrisch verstelbare zit-stafels met stabiele T-poot of als stevige H-duobench. Hoogte verstelbaar van 65 tot 130cm met 2 sterke en stille motoren rechtstreeks op de 3-delige kolompoten. Standaard voorzien van memory unit met 4 geheugens en een praktische USB-A charger. Het stevige ladderframe is verstelbaar van 110 tot 190cm voor bladen tot 200cm lang en een bladdiepte van 70 tot 100cm. Onder het blad worden alle kabels en elektronica netjes opgeborgen in een gestoffeerde magnetische kabelbak.

Voor de bench is optioneel de handige telescopische centrale kabelbak leverbaar in de 3 ralkleuren, netjes afgesloten door 2 afdekplaten en standaard geleverd met 2 kabelslangen in de juiste kleur.

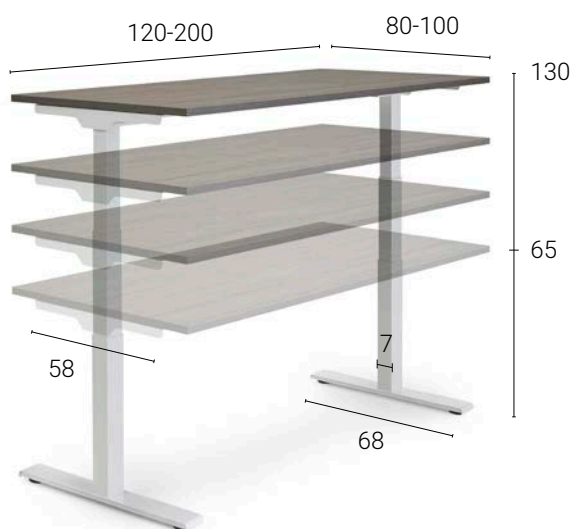

S-Line is elektrisch in hoogte verstelbaar van 65 tot 130cm (incl. 25mm tafelblad). Dynamisch gewicht max 125kg incl. anti-collision sensor.



De meegeleverde magnetische kabelbak verbergt netjes alle kabels en elektronica



Standaard memory-unit met 4 geheugen posities en handige USB-A charger.



**Gewicht capaciteit**  
125 kg



**Stroom verbruik**  
Standby < 0,5 W



**Snelheid**  
38 mm/s



**Verstelbereik**  
65 - 130 cm



**Geluidsniveau**  
< 38 dB



VOORRAAD



LEVERTIJD



GARANTIE



CIRCULAIR



ARBO KEUR



CONFIGUREERBAAR



MONTAGE



S-line bench met telescopische kabelbak en kabelslangen



S-line onderstellen zijn modulair: bouw 2 single frames om naar een bench of andersom.

Model	Bladmaat
S-Line single 120	120 x 80
S-Line single 140	140 x 80
S-Line single 160	160 x 80
S-Line single 180	180 x 80
S-Line single 180	180 x 90
S-Line single 200	200 x 80
S-Line single 200	200 x 100

Model	Bladmaat
S-Line bench 120-165	120 x 80
S-Line bench 140-165	140 x 80
S-Line bench 160-165	160 x 80
S-Line bench 180-165	180 x 80
S-Line bench 200-165	200 x 80

**Opties**

Telescopische kabelbak met afdeklatten, incl. 2 kabelslangen

PL-S persoonlijke lade

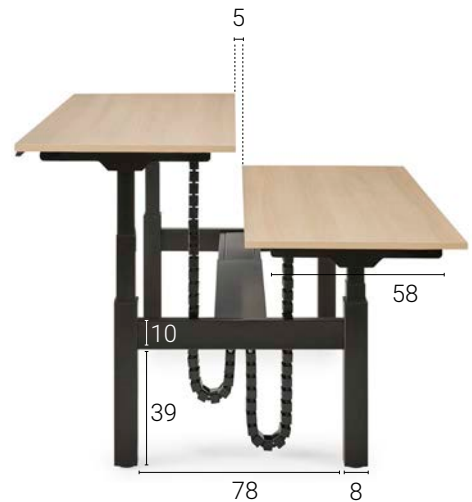

VOORRAAD

**Frame kleuren**



VOORRAAD

**Blad groep 1  
Melamine 25mm op voorraad**

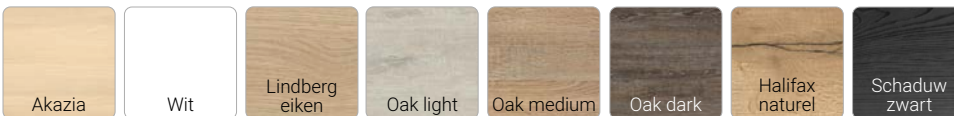

LEVERTIJD

**Blad groep 2  
Melamine 25mm op bestelling**

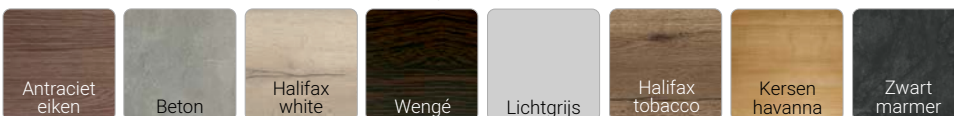

LEVERTIJD

**Blad groep 3  
Quadrifoglio melamine 25mm op bestelling**

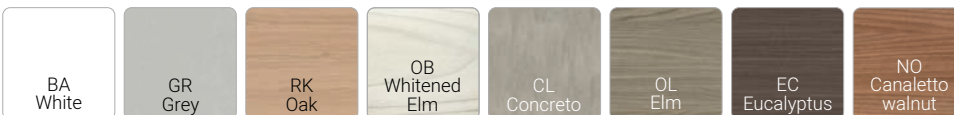



## Flex Eco+ 160x80

### Bestaande uit:

- 1x Flex Eco+ 160 Shadow grey
- 1x Blad 160x80 CL Concreto

Getoond: Q4 ladenblok in CL Concreto, Power Desk-up en bureaustoel SW-1 mesh

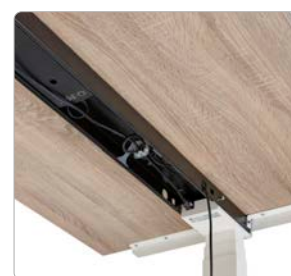

Centrale traverse onder het bureau waarin kabels en controller netjes worden weggewerkt



**Gewicht capaciteit**  
100 kg



**Stroom verbruik**  
In gebruik 118 W  
Standby < 0,3 W



**Snelheid**  
40 mm/s tot 100 kg



**Verstelbereik**  
64 - 130 cm



**Geluidsniveau**  
< 38 dB(A)



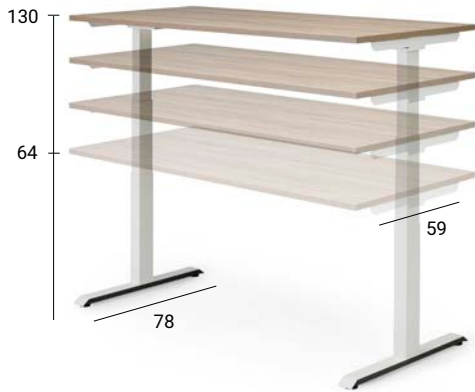

Flex Eco+ is elektrisch in hoogte verstelbaar van 64 tot 130 cm (incl 25mm tafelblad).  
Leverbaar als enkele werkplek in diverse maatvoeringen.

De stille en sterke motoren zijn rechtstreeks gemonteerd op de 3-delige kolompoten. In de stabiele C-traverse worden de kabels en controller netjes verwerkt en aan het zicht onttrokken. Geen losse onderdelen dus gebruiksvriendelijk en onderhoudsvrij.

De up-down bediening en optionele memory-unit zijn zowel links als rechts onder het bureaublad te plaatsen.

Model	Bladmaat
Flex Eco+ 120	120 x 80
Flex Eco+ 140	140 x 80
Flex Eco+ 160	160 x 80
Flex Eco+ 180	180 x 80
Flex Eco+ 180	180 x 90
Flex Eco+ 200	200 x 80
Flex Eco+ 200	200 x 100



Overige opties en accessoires zie pagina 97



Strak vormgegeven teen met stabiele 3-delige kolompoet



Flex Eco+ onderstel  
Voorraad kleuren

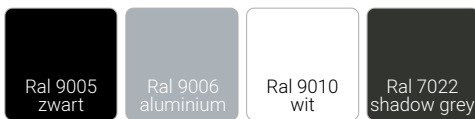

Blad groep 1  
Melamine 25mm op voorraad

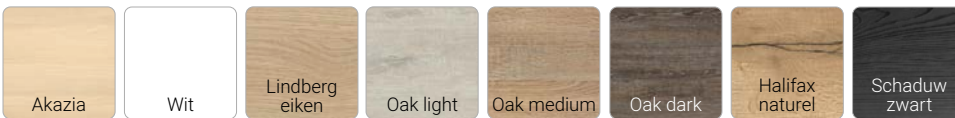

Blad groep 2  
Melamine 25mm op bestelling

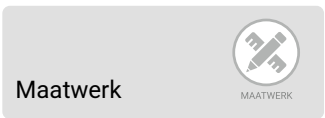
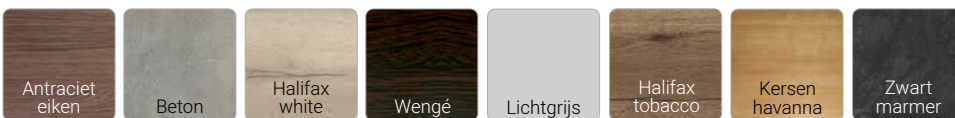

Maatwerk



Blad groep 3  
Quadrifoglio melamine 25mm op bestelling

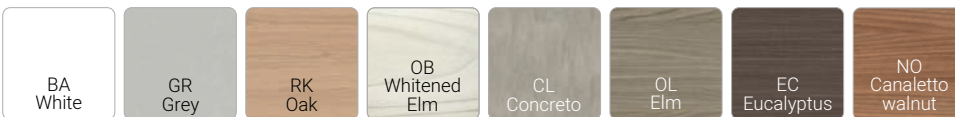

Ook maatwerk op aanvraag in elke gewenste maatvoering op bestelling leverbaar, rekening houdend met maximale plaatmaten (levertijd 4-6 weken).



## Flex 3+ 160x80

### Bestaande uit:

1x Flex 3+ 160 Shadow grey  
1x blad 160x80cm CL Concreto  
Getoonde bureaustoel: SW-1



Centrale traverse onder het bureau  
waarin kabels en controller netjes  
worden weggewerkt



**Gewicht capaciteit**  
100 kg



**Stroom verbruik**  
In gebruik 118 W  
Standby < 0,3 W



**Verstelbereik**  
64 - 130 cm



**Geluidsniveau**  
< 38 dB(A)



**Snelheid**  
40 mm/s tot 100 kg



Modulair systeem: maak van Flex3+  
een wang of bench opstelling!



Flex 3+ is elektrisch in hoogte verstelbaar van 64 tot 130cm (incl. 25mm tafelblad). Leverbaar als enkele werkplek, hoekopstelling en functionele duo-bench.

De twee stille en sterke motoren zijn rechtstreeks gemonteerd op de 3-delige kolompoten. In de stabiele E-traverse worden de kabels en controller netjes verwerkt en aan het zicht onttrokken. Geen losse onderdelen dus gebruiksvriendelijk en onderhoudsvrij.

De standaard meegeleverde memory-unit is zowel links als rechts onder het bureaublad te plaatsen. Maximale en minimale hoogte van de tafel kunt u eenvoudig zelf programmeren, bijvoorbeeld als u een ladenblok onder het bureau heeft staan.

Een extra optie is de instelbare Flex safety sensor waarmee de tafel meteen reageert bij een lichte aanraking of botsing.

Model	Bladmaat
Flex 3+ 120	120 x 80
Flex 3+ 140	140 x 80
Flex 3+ 160	160 x 80
Flex 3+ 180	180 x 80
Flex 3+ 180	180 x 90
Flex 3+ 200	200 x 80
Flex 3+ 200	200 x 100

Optie



Flex safety sensor (Verticaal binnen/buitenzijde E-traverse monteren)

Overige opties en accessoires zie pagina 97



Strak vormgegeven teen met stabiele 3-delige kolompot en standaard memory-unit



Flex 3+ onderstel  
Voorraad kleuren

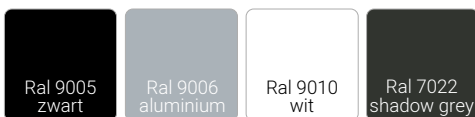

Blad groep 1  
Melamine 25mm op voorraad

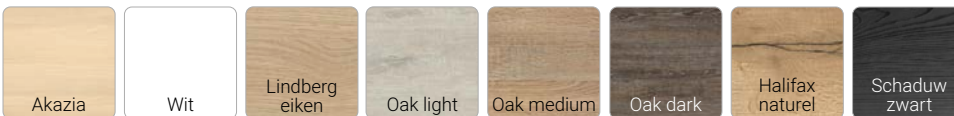

Blad groep 2  
Melamine 25mm op bestelling

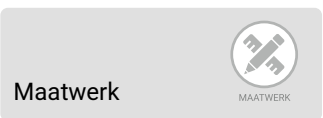
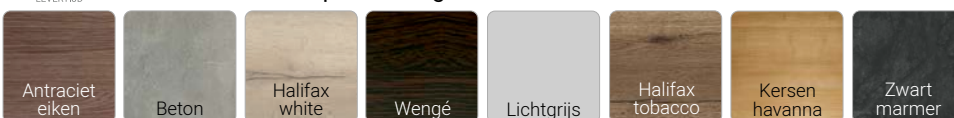

Maatwerk



Blad groep 3  
Quadrifoglio melamine 25mm op bestelling

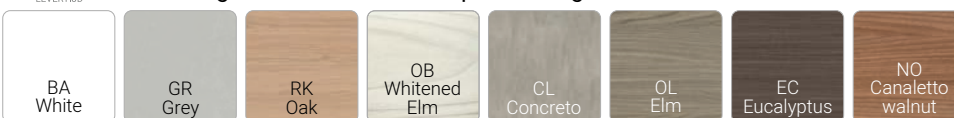

Ook maatwerk op aanvraag in elke gewenste maatvoering op bestelling leverbaar, rekening houdend met maximale plaatmaten (levertijd 4-6 weken).



## Flex 3+ aanbouw 200x180

### Bestaande uit:

- 1x Flex 3+ 200 wit met memory unit
- 1x Flex 3+ aanbouw wit incl. 2x koppelplaatje
- 1x blad 200x80cm Halifax naturel
- 1x blad 60x100cm Halifax naturel

Getoond: bureaustoel SW-1  
 Staande lamp Eco-light tripod in 83 gold  
 Monitorarm Galaxy wit met stroom-unit



Flex 3+ meeting 240 zie pag. 152



#### Gewicht capaciteit

150 kg



#### Stroom verbruik

In gebruik 177 W  
 Standby < 0,3 W



#### Verstelbereik

64 - 130 cm



#### Geluidsniveau

< 38 dB(A)



#### Snelheid

40 mm/s tot 150 kg



Modulair systeem: maak van Flex3+  
 een wang of bench opstelling!

Breidt uw Flex3+ bureau uit met de praktische Flex 3+ aanbouw. Standaard wordt de Flex 3+ aanbouw geleverd met een memory bediening.

Tip: als u het 3-poots onderstel in de lengte plaatst kunt u zeer grote zit-sta tafels op maat creëren. Zie Flex 3+ meeting op pag 152 of vraag naar de mogelijkheden.

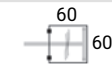
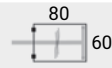
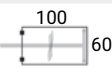
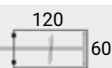

Model	Bladmaat
Flex 3+ 160 met aanbouw	160 x 80
Flex 3+ 180 met aanbouw	180 x 80
Flex 3+ 180 met aanbouw	180 x 90
Flex 3+ 200 met aanbouw	200 x 80
Flex 3+ 200 met aanbouw	200 x 100

Aanbouwbladen
60 x 60 
60 x 80 
60 x 100 
60 x 120 

**Optie**



Flex safety sensor (Verticaal binnen/buitenzijde E-traverse monteren)

Overige opties en accessoires zie pagina 97

Inclusief koppelplaatjes (2 stuks nodig: voorkomt speling op bladen) en verlengkabel 120cm.



Standaard memory unit



**Flex 3+ onderstel**  
Voorraad kleuren

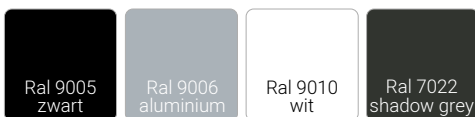

**Blad groep 1**  
Melamine 25mm op voorraad

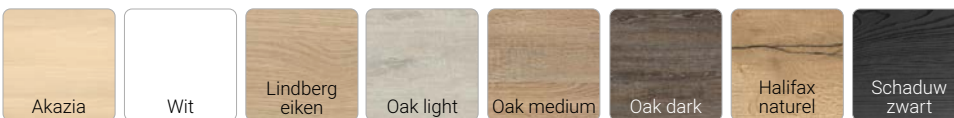

**Blad groep 2**  
Melamine 25mm op bestelling

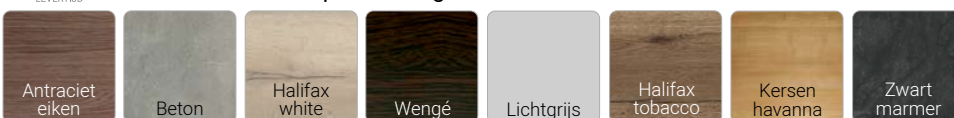

**Blad groep 3**  
Quadrifoglio melamine 25mm op bestelling

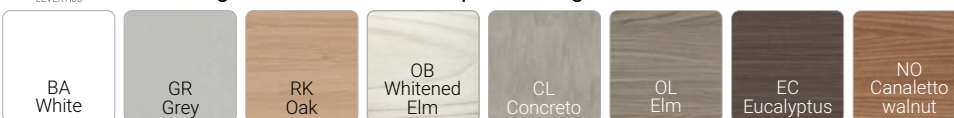

**Maatwerk**



Ook maatwerk op aanvraag in elke gewenste maatvoering op bestelling leverbaar, rekening houdend met maximale plaatmaten (levertijd 4-6 weken).



## Flex 3+ Wang 160x80

### Bestaande uit:

1x Flex 3+ Wang 160 Shadow grey  
1x blad 160x80cm Lindberg eiken

Getoond: Bureaustoel SW-1 mesh,  
ECO-screen 9 opzetwand 140x40cm met V-groef éézijdig

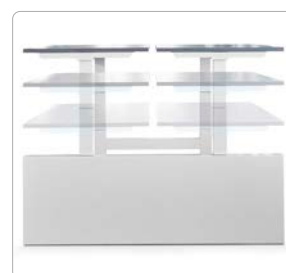

Ook als bench leverbaar.



**Gewicht capaciteit**  
100 kg



**Stroom verbruik**  
In gebruik 118 W  
Standby < 0,3 W



**Snelheid**  
40 mm/s tot 100 kg



**Verstelbereik**  
64 - 130 cm



**Geluidsniveau**  
< 38 dB(A)



Modulair systeem: maak van Flex3+  
een wang of bench opstelling!



VOORRAAD



LEVERTIJD



GARANTIE



CIRCULAIR



ARBO KEUR



CONFIGUREERBAAR



MONTAGE

Geef uw Flex 3+ bureau een extra robuuste uitstraling met de modulaire Flex wangenpoot. De zware metalen wang heeft een dikte van 10cm en zorgt voor een fraaie opgeruimde werkplek.

Uit voorraad leverbaar in diverse maten voor zowel enkele werkplekken als duo-benches in ral 9005 zwart en ral 9010 wit. De wang is tevens achteraf te monteren op uw bestaande Flex+ werkplek.



Model	Bladmaat
Flex 3+ 120 wang 80	120 x 80
Flex 3+ 140 wang 80	140 x 80
Flex 3+ 160 wang 80	160 x 80
Flex 3+ 180 wang 80	180 x 80
Flex 3+ 180 wang 90	180 x 90
Flex 3+ 200 wang 80	200 x 80
Flex 3+ 200 wang 100	200 x 100

#### Losse wangenpoot

- Losse wangenpoot 80cm per stuk
- Losse wangenpoot 90cm per stuk
- Losse wangenpoot 100cm per stuk

#### Optie



Flex safety sensor  
(Verticaal binnen/buitenzijde  
E-traverse monteren)

Overige opties en accessoires  
zie pagina 97



VOORRAAD

#### Flex 3+ onderstel Voorraad kleuren

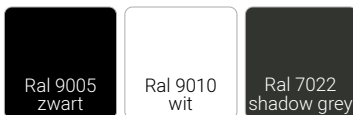

VOORRAAD

#### Blad groep 1 Melamine 25mm op voorraad

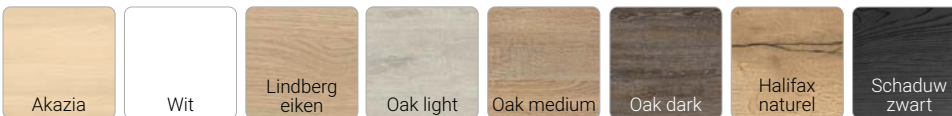

LEVERTIJD

#### Blad groep 2 Melamine 25mm op bestelling

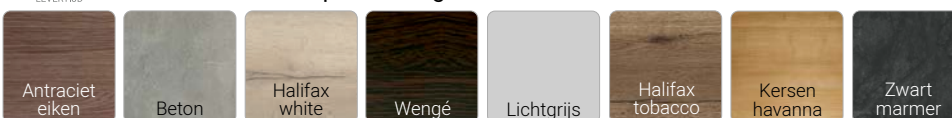

LEVERTIJD

#### Blad groep 3 Quadrifoglio melamine 25mm op bestelling

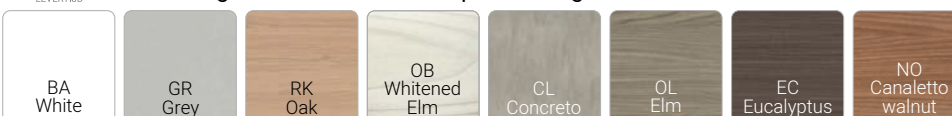

Standaard memory unit

#### Maatwerk



MAATWERK

Ook maatwerk op aanvraag in elke gewenste maatvoering op bestelling leverbaar, rekening houdend met maximale plaatmaten (levertijd 4-6 weken).



## Flex 3+ bench 160

### Bestaande uit:

2x blad 160x80cm Halifax naturel

1x Flex kabelbak 160 incl 2 kleppen wit

1x Eco screen 18 benchwand 160x80 kleur 12 met rail wit magnetisch en V-groef 2-zijdig

Getoond: bureaustoel Custom Thor en 1x Eco-light tafellamp zwart



Optionele koppelstukken en koppelgootje bij 2 H-frames (15cm tussenruimte)



#### Gewicht capaciteit

100 kg



#### Stroom verbruik

In gebruik 118 W  
Standby < 0,3 W



#### Verstelbereik

64 - 130 cm



#### Geluidsniveau

< 38 dB(A)



#### Snelheid

40 mm/s tot 100 kg



Modulair systeem: maak van Flex3+ een wang of bench opstelling!



Flex 3+ bench heeft als duo werkplek een stabiel H-frame en is traverse-vrij voor optimale bewegingsvrijheid. In hoogte verstelbaar van 64 tot 130cm en optioneel uitvoerbaar met metalen wangenpoten in 165 en 185cm.

Standaard geleverd met 2x memory unit.  
Tip: voor een veilig en opgeruimd kabelmanagement kies voor de centrale kabelbak met set kabelslangen.

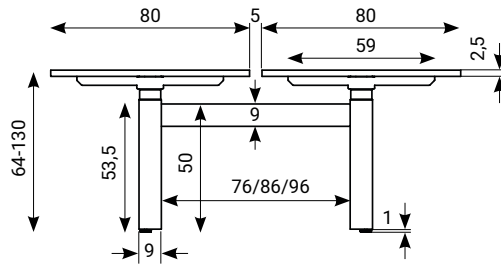
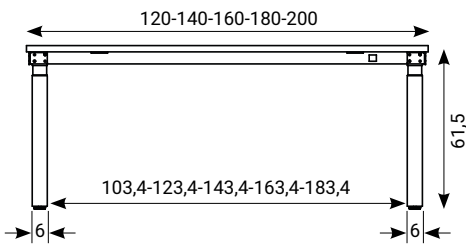

Model	Bladmaat
Flex 3+ bench 120-165	120 x 80
Flex 3+ bench 140-165	140 x 80
Flex 3+ bench 160-165	160 x 80
Flex 3+ bench 180-165	180 x 80
Flex 3+ bench 180-185	180 x 90
Flex 3+ bench 200-165	200 x 80
Flex 3+ bench 200-205	200 x 100

- Opties**
- Safety collision sensor, met programmeerbare gevoeligheid
  - Set á 2 koppelstukken in wit, alu en zwart
  - Koppelgootje tbv 2 H-frames, in wit, alu en zwart
  - Kabelbak 160 incl. 2 kleppen in wit, alu en zwart
  - Kabelbak 180 incl. 2 kleppen in wit, alu en zwart
  - Kabelbak telescopisch 140-200 met deksel in wit, alu en zwart
  - Set á 2x kabelslang 33-delig in wit, alu en zwart

Overige opties en accessoires zie pagina 97



Flex 3+ bench onderstel  
Voorraad kleuren

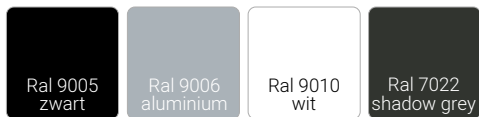

Standaard memory unit



Blad groep 1  
Melamine 25mm op voorraad

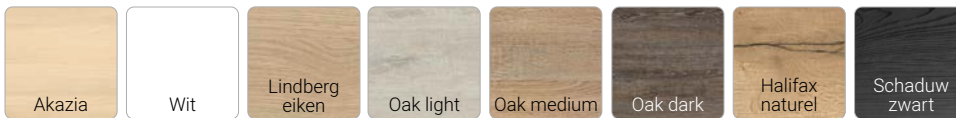

Blad groep 2  
Melamine 25mm op bestelling

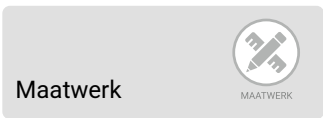
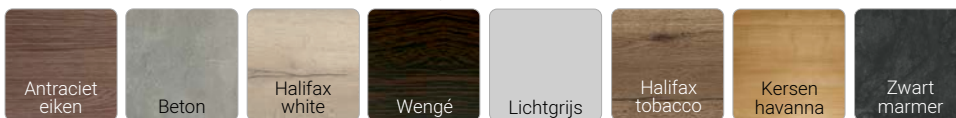

Maatwerk



Blad groep 3  
Quadrifoglio melamine 25mm op bestelling

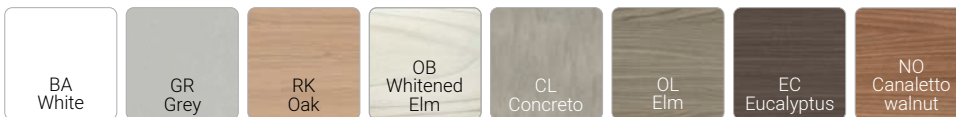

Ook maatwerk op aanvraag in elke gewenste maatvoering op bestelling leverbaar, rekening houdend met maximale plaatmaten (levertijd 4-6 weken).



Flex 3+ wang aanbouw 80

Wang poot	Bladmaat	T-poot	Bladmaat
Flex 3+ wang aanbouw 60	60 x 60	Flex 3+ aanbouw 60	60 x 60
Flex 3+ wang aanbouw 80	60 x 80	Flex 3+ aanbouw 80	60 x 80
Flex 3+ wang aanbouw 100	60 x 100	Flex 3+ aanbouw 100	60 x 100
Flex 3+ wang aanbouw 120	60 x 120	Flex 3+ aanbouw 120	60 x 120



Flex 3+ aanbouw 80

 **Gewicht capaciteit**  
100 kg

 **Stroom verbruik**  
In gebruik 118 W  
Standby < 0,3 W

 **Verstelbereik**  
64 - 130 cm

 **Geluidsniveau**  
< 38 dB(A)

 **Snelheid**  
40 mm/s tot 100 kg



Modulair systeem: maak van Flex3+ een wang of bench opstelling!



Flex 3+ Bench 160  
(Wang 165 + H-poot 165)

Model		Bladmaat
Flex 3+ Bench 120	Wang 165 + H-poot 165	120 x 80
Flex 3+ Bench 140	Wang 165 + H-poot 165	140 x 80
Flex 3+ Bench 160	Wang 165 + H-poot 165	160 x 80
Flex 3+ Bench 180	Wang 165 + H-poot 165	180 x 80
Flex 3+ Bench 180	Wang 185 + H-poot 185	180 x 90
Flex 3+ Bench 200	Wang 165 + H-poot 165	200 x 80



Flex 3+ bench onderstel  
Voorraad kleuren



Standaard memory unit

Overige opties en accessoires zie pagina 97



Blad groep 1  
Melamine 25mm op voorraad

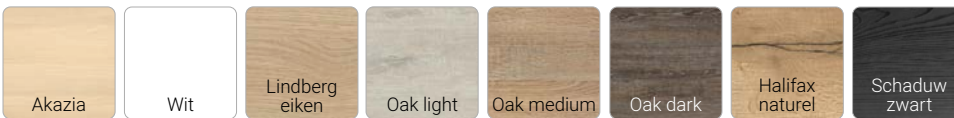

Blad groep 2  
Melamine 25mm op bestelling

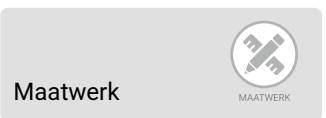
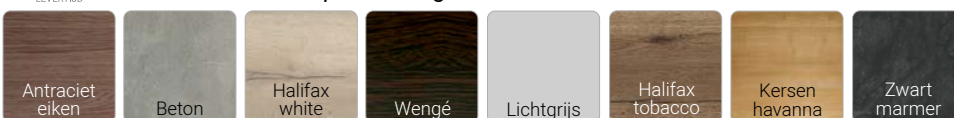

Maatwerk



Blad groep 3  
Quadrifoglio melamine 25mm op bestelling

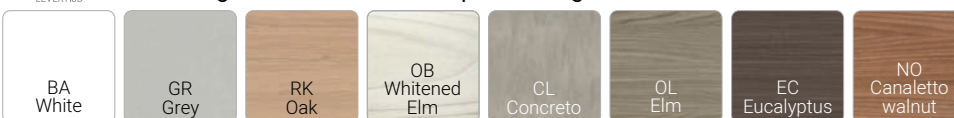

Ook maatwerk op aanvraag in elke gewenste maatvoering op bestelling leverbaar, rekening houdend met maximale plaatmaten (levertijd 4-6 weken).



## Flex 3+ bench 160 wang 165

### Bestaande uit:

- 1x Flex 3+ bench 180 wang 165 Shadow grey
- 2x blad 160x80cm OL Elm
- 1x Flex kabelbak telescopisch 140-200 Shadow grey
- 1x Basic+ benchwand afgerond 160x80 in Cara Lead met magnetische bevestiging

Getoond: bureaustoel Custom Thor



Standaard memory bediening met 4 geheugenstanden

 **Gewicht capaciteit**  
100 kg

 **Stroom verbruik**  
In gebruik 118 W  
Standby < 0,3 W

 **Verstelbereik**  
64 - 130 cm

 **Geluidsniveau**  
< 38 dB(A)

 **Snelheid**  
40 mm/s tot 100 kg



Modulair systeem: maak van Flex3+ een wang of bench opstelling!



VOORRAAD



LEVERTIJD



GARANTIE



CIRCULAIR



ARBO KEUR



CONFIGUREERBAAR



MONTAGE

Traversevrij wangenframe met optimale bewegingsruimte en een zit-stahoogte van 64 tot 130cm. Flex 3+ bench wang is een duo-werkplek met gesloten motor-units rechtstreeks op de kolompoot, extra stil en zeer stabiel.

De 10cm dikke metalen wang is uit voorraad leverbaar in de maten 165 en 185cm in wit, shadow grey en zwart.

Flex3+ bench wang is uitgevoerd met modulaire zit-sta kolommen voor uw ideale combinaties met wang- en H-poten.

Met de slimme elektronica kunt u eenvoudig zelf de minimale en maximale hoogte instellen. De dynamische belasting is 100 kilogram, met een stand-by stroomverbruik van minder dan 0,3 Watt per tafel. Standaard geleverd met memory unit.



Model	Bladmaat
Flex 3+ bench 120 wang 165	120 x 80
Flex 3+ bench 140 wang 165	140 x 80
Flex 3+ bench 160 wang 165	160 x 80
Flex 3+ bench 180 wang 165	180 x 80
Flex 3+ bench 180 wang 185	180 x 90
Flex 3+ bench 200 wang 165	200 x 80

#### Opties

- Safety collision sensor met programmeerbare gevoeligheid
- Telescopische kabelbak met deksel 140-200 cm
- Set á 2x kabelslang 33 delig incl. 2 magneten in wit en zwart
- Losse wangenpoot 165cm
- Losse wangenpoot 185cm

Voor meer opties zie pag. 97



VOORRAAD

#### Flex 3+ bench wang onderstel Voorraad kleuren

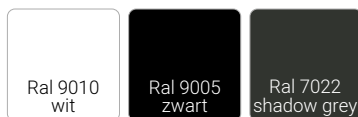

VOORRAAD

#### Blad groep 1 Melamine 25mm op voorraad

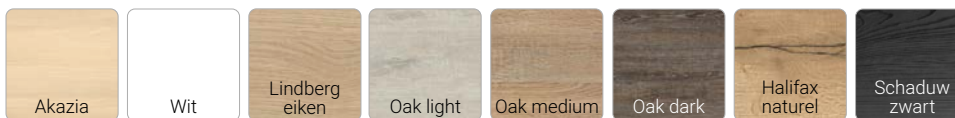

LEVERTIJD

#### Blad groep 2 Melamine 25mm op bestelling

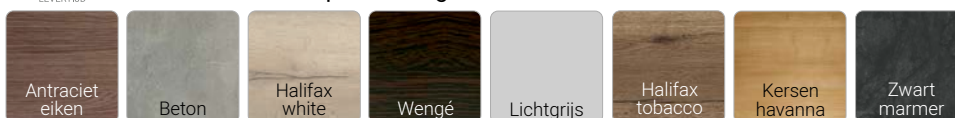

LEVERTIJD

#### Blad groep 3 Quadrifoglio melamine 25mm op bestelling

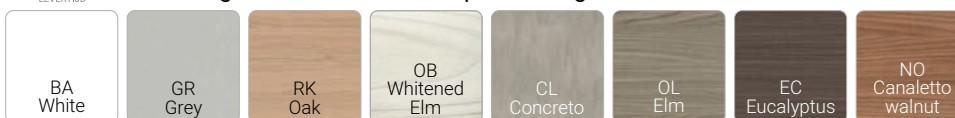

SCAN  
VOOR  
PRIJSLIJST



MAATWERK

#### Maatwerk

Ook maatwerk op aanvraag in elke gewenste maatvoering op bestelling leverbaar, rekening houdend met maximale plaatmaten (levertijd 4-6 weken).



Een ergonomisch directiebureau met aanbouw, dat is de Flex 3+ manager. Stel zelf uw ideale hoek samen met de vele maten bureaubladen, kies het type onderstel (T-poot of wang) en configureer uw aanbouwkast in de gewenste uitvoering.

De speciaal vervaardigde kasten zijn compleet uitgerust met softclose deuren en voorzien van handige legplanken. De achterzijde van de kast is keurig vlak en solide afgewerkt voor plaatsing in elke ruimte. De elektrisch verstelbare werkplek is standaard voorzien van een memory-unit met hoogte aanduiding.



### Getoonde opstelling:

Bureau Flex 3+ 200 en één zijde wangenpoot 80cm wit, blad 200x80 Halifax naturel en kast 4-deurs wit met ladenblok en ombouw Halifax naturel. Getoonde bureaustoel Diade Rock



Standaard memory bediening met 4 geheugenstanden



**Gewicht capaciteit**  
100 kg



**Stroom verbruik**  
Standby < 0,5 W



**Snelheid**  
40 mm/s



**Verstelbereik**  
64 - 130 cm



**Geluidsniveau**  
< 50 dB



Modulair systeem: maak van Flex3+ een wang of bench opstelling!



**Getoonde opstelling:**

Flex 3+ 200 T-poot shadow grey, blad 200x80 Halifax naturel en kast 165x50,5x54h versie 4-deurs zwart met greepjes shadow grey. Getoonde bureaustoel SW-1.

Zit-sta managerbureau in hoogte verstelbaar 64-130cm

Flex 3+ manager kast modellen	Maatvoering (bxdxh)
Kast 2-deurs met kolomsupport (incl. 1 legbord)	80 x 50 x 54cm (incl. topblad 25mm)
Kast 2-deurs incl. 1 legbord	80 x 50 x 54cm (incl. topblad 25mm)
Kast 3 laden met softclose	40 x 50 x 54cm (incl. topblad 25mm)

Flex 3+ manager kastombouwen 25mm	Maatvoering (bxdxh)
Kastombouw 4-deurs	165 x 50,5 x 54cm
Kastombouw 4-deurs met ladenblok	205 x 50,5 x 54cm



**Flex 3+ onderstel metaalkleuren**



**Aanbouwkast kleuren Corpus en deuren**

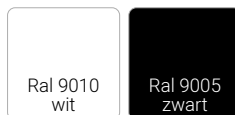

**Blad en kastombouw kleuren**

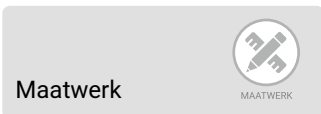
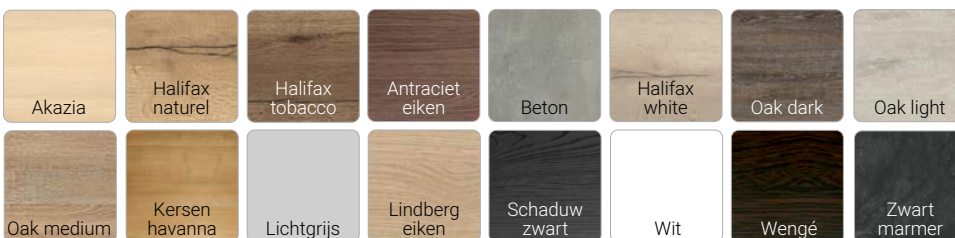

Ook maatwerk op aanvraag in elke gewenste maatvoering op bestelling leverbaar, rekening houdend met maximale plaatmaten (levertijd 4-6 weken).







VOORRAAD



GARANTIE



MONTAGE

**Flex accessoires**



Memory unit met 4 geheugens en LED-display



MCT Flex magnetische en gestoffeerde kabelbak 79cm breed



Flex safety-collision sensor (Verticaal binnen/buitenzijde E-traverse monteren)



Flex klapbare kabelgoot zwart 105cm 145cm 165cm



Power Desk Up 3x 220V in wit of zwart met 0,4m GST18  
Power Desk Up 2x 220V en 2x USB charger in wit of zwart met 0,4m GST18  
Los aansluitnoer 3m GST18



Kabelgoot Turn 79cm in wit, zwart of alu  
Kabelgoot Turn 115cm in wit, zwart of alu  
Kabelgoot Turn 145cm in wit, zwart of alu



Stekkerdoos 3x 220V incl. aansluitsnoer 3m GST18  
Stekkerdoos 4x 220V incl. aansluitsnoer 3m GST18

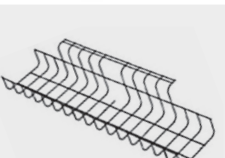

Kabelkorf 49cm wit, zilver en zwart  
Kabelkorf 79cm wit, zilver en zwart



38-delige kabelslang in wit, alu of zwart (131h)



Flexy kabelgoot inclusief montagebeugels. Leverbaar in zwart, wit en zilver. 2 lengtes van 60 en 100cm.



PL-1 persoonlijke lade in wit, alu, shadow grey of zwart



Motorverlengkabel 120cm tbv langere aanbouw (bij totaal aanbouwmaat >200cm)

**Bench accessoires**



Centrale kabelbak vast tbv H-frame 160 incl. 2 kleppen. In wit, alu, shadow grey of zwart  
Centrale kabelbak vast tbv H-frame 180 incl. 2 kleppen. In wit, alu, shadow grey of zwart



Set á 2x kabelslang 33-delig incl. magneet in wit, alu of zwart (icm centrale kabelbak)



Centrale kabelbak telescopisch tbv H- of wangenframe 140-200 incl. deksel. Leverbaar in wit, alu, shadow grey of zwart.



Koppelgoot tbv geleiding kabels tussen 2 benches (icm set 2 koppelstukken)  
Set van 2 koppelstukken wit, alu, shadow grey of zwart



Wandhouder kopse kant H-frame set á 2 stuks in wit, alu, shadow grey of zwart (excl. klemmen)



Flex 3+ aanbouwsteun ter ondersteuning van het overstekende werkblad bij o.a. meetingtafels. Leverbaar in zwart. Afmeting: 38x25cm. (zowel voor single als bench)



De Follow van het Italiaanse Mara is een hoogte verstelbare tafel (66-116cm) waar u met één knop eenvoudig, snel en stroomloos de juiste positie kunt vinden.

Het robuuste onderstel is leverbaar in 2 maten (114 en 154cm) en te verkrijgbaar in diverse fraaie kleuren. de bewegende kolommen zijn uitgevoerd in slijtvast en milieuvriendelijk tri-chroom.

Optioneel is de Follow desk te voorzien van stevige zwenkwielen met rem. Optimale vrijheid om te werken waar u maar wilt.



Follow Desk 299F large in kleur zand RAL 7044 met blad 160x80 Q4 eucalyptus.  
Getoonde bureaustoel Custom Thor NPR. Ladenblok Q4 melamine 3-laden in eucalyptus.



**Gewicht capaciteit**

20 - 30 kg  
(belasting op bureau)



**Verstelbereik**

66 - 116 cm



**Stroom verbruik**

Geen



**Snelheid**

Manuele contraveer



**Geluidsniveau**

Geen

**mara**<sup>®</sup>

Follow desk is tevens leverbaar als bench duo-werkplek. De stoere H-poot draagt twee individueel verstelbare tafels. Het resultaat is een minimaal en efficiënt onderstel, en biedt u ook de mogelijkheid om centraal de kabels te verwerken met de optionele Follow kabelbak of kies voor een akoestische scheidingswand op vaste hoogte.

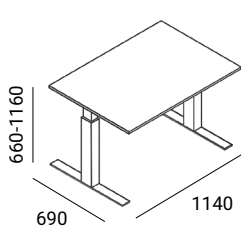

Follow desk 299F small  
bladmaat 120x80 of  
140x80cm

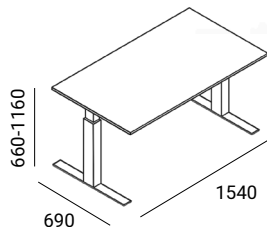

Follow desk 299F large  
bladmaat 160x80,  
180x80 of 180x90cm

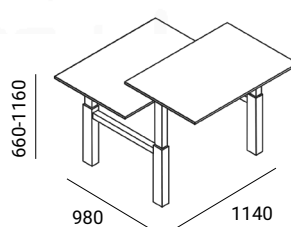

Follow bench 299B small  
bladmaat 120x80 of  
140x80cm

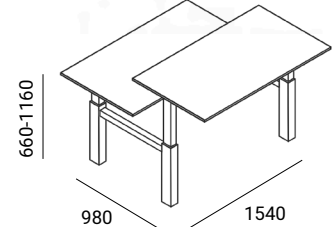

Follow bench 299B large  
bladmaat 160x80 of  
180x80cm



LEVERTIJD

Follow metaalkleuren



VOORRAAD

Blad groep 1  
Melamine 25mm op voorraad

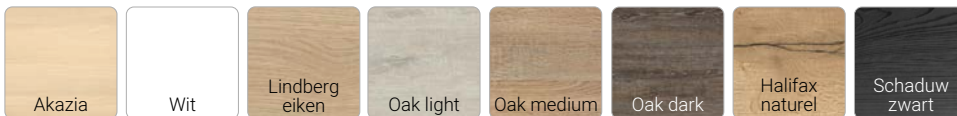

LEVERTIJD

Blad groep 2  
Melamine 25mm op bestelling

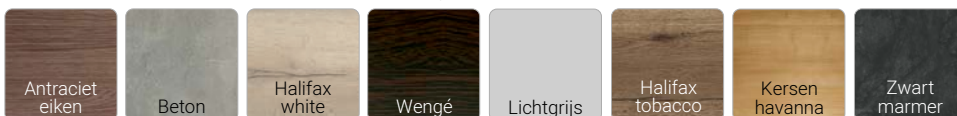

LEVERTIJD

Blad groep 3  
Quadrifoglio melamine 25mm op bestelling

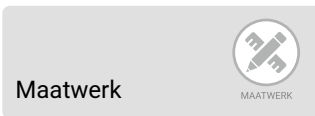
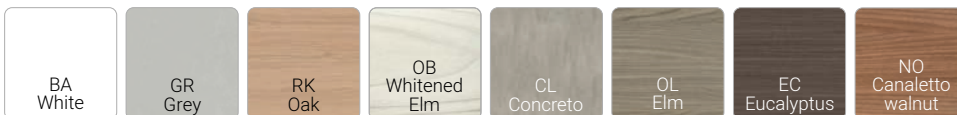

Maatwerk

Ook maatwerk op aanvraag in elke gewenste maatvoering op bestelling leverbaar, rekening houdend met maximale plaatmaten (levertijd 4-6 weken).



**d**UTCHCREEN

"Ssssst,  
mag het wat  
stiller?"



## Over akoestiek op de werkplek.

Diverse onderzoeken hebben aangetoond dat overlast van geluid op ons werk een groot effect heeft op de productiviteit en zelfs kan leiden tot stress en ziekte. De moderne kantoortuinen met vaak een open structuur en de hedendaagse arbeidsomstandigheden in onze dynamische wereld vragen ons daarom om passende akoestische oplossingen.

## Wat is NRC waarde?

Hoeveel geluid een akoestisch materiaal absorbeert wordt aangegeven in de NRC waarde (Noise Reduction Coëfficiënt), en gaat van 0 tot 1. Bij de waarde 1,0 worden alle geluidsgolven volledig opgenomen, dit is ideaal want er komt niets terug. Bij de waarde 0 wordt het geluid echter 100% weerkaatst en blijft hierdoor actief, denk bijvoorbeeld aan glas of harde materialen. Het is dus logisch dat bij een akoestische oplossing goed gekeken moet worden naar alle oppervlaktes in de bewuste ruimte! De juiste scheidingswanden op uw werkplek en dus dicht bij de geluidsbron kunnen al zeer effectief zijn, en geven naast een rustig zichtbeeld ook beduidend minder geluidsoverlast.

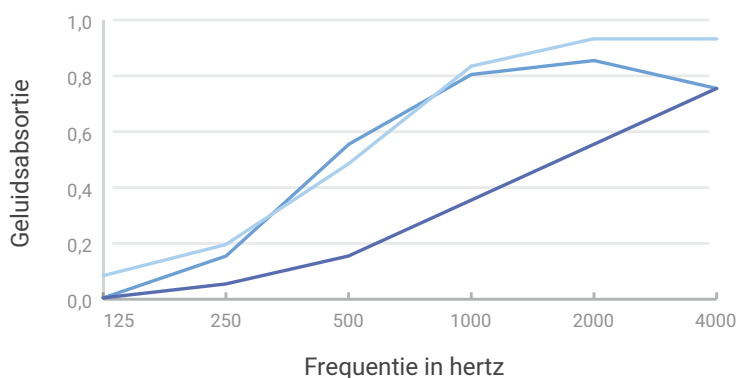

GEBIED VAN NRC-WAARDE  
250 - 2000 hertz

ECO screen akoestisch:

- Eco-screen 9 mm
- Eco-screen 18 mm
- Eco-screen 25 mm

## De mogelijkheden:

Scheidingswanden zijn er in tal van uitvoeringen, van opzetwanden aan uw bureaublad tot volledig vrijstaande wanden. Los van de mogelijkheden in afwerking aan de buitenzijde wordt zoals aangegeven de akoestische werking vooral bepaald door wat er in de wand zit, daar waar de geluidsgolven geabsorbeerd worden.



De akoestische wanden van ECO-screen zijn vervaardigd uit gerecyclede PET flessen. Dit maakt ze economisch, licht en ook bijzonder duurzaam. Voor 1 m<sup>2</sup> paneel van 18mm worden al 120 PET flessen verwerkt! Een zeer fraai en verantwoord product met ongekende toepassingen, van zichtschot tot vrijstaande scheidingswand en zelfs geschikt als kastbekleding.



## Basic+ en Mute wanden

Made in Holland en lekker duurzaam. Dat mogen we weg zeggen over deze serie scheidingswanden. Natuurlijk met hoge akoestische eigenschappen en uitvoerbaar in diverse stof- en kleursoorten.

De Basic+ wanden serie is vervaardigd van gerecyclede 25mm dikke bureaubladen waar de kern uit wordt gefreesd om die weer op te vullen met gerecyclede jeans, hoe duurzaam wilt u het hebben!

De Mute serie heeft een houten kader voorzien van gerecyclede jeans vulling voor optimaal akoestisch resultaat. Kies voor de strakke rechte hoeken of de organische ronde hoeken. De bijbehorende klemmen houden de wand netjes op zijn plaats zowel aan uw bureaublad als tussen de bladen bij een duo-bench.

Basic+ en Mute scheidingswanden kunnen naar wens met rechte of afgeronde hoeken worden geleverd.



## Akoestische achterwanden en vrijstaande wanden

Voor de akoestiek bij vrij geplaatste kasten of open ruimtes bieden wij u diverse oplossingen. De kasten zijn te voorzien van akoestische achterwanden voor een fraai en akoestisch effect. Met een keur aan verschillende vrijstaande wanden heeft u de meest flexibele oplossing en zorgt u daarnaast voor een functionele ruimte-separatie.





Mute wanden hebben een sterk houten kader met een akoestische kern van gerecyclede jeans stof. Leverbaar in Camira Cara of Fabraa I-stoffering (Soil). Uit voorraad leverbaar in diverse maten in Cara Lead of Glass.



Mute wand met rechte hoeken uit voorraad leverbaar.



Mute wand met afgeronde hoeken op bestelling leverbaar (4-6 wk)



De Mute heeft een houten kader voorzien van gerecyclede jeans vulling voor optimaal akoestisch resultaat. Kies voor de strakke rechte hoeken of de organische ronde hoeken. De bijbehorende klemmen houden de wand netjes op zijn plaats zowel aan uw bureaublad als tussen de bladen bij een duo-bench.

Opbouw akoestische wanden

- Stoffering met laagje recyclede jeans
- Kern van gerecyclede jeans
- Dun houten middenpaneel

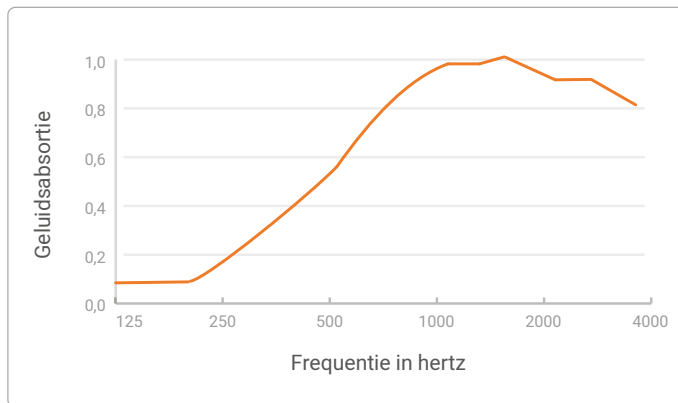
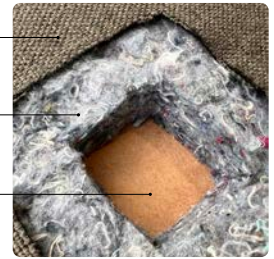

Wat is het akoestische effect?

Elk materiaal heeft een absorptiewaarde variërend van 0 tot 1, waarbij 0 de geluidsgolven volledig weerkaatst (denk aan glas) en 1 volledig absorbeert.

Mute scheidingswand



Opzetwanden Mute (bxh)

- 140 x 40cm (excl. 2 klemmen)
- 160 x 40cm (excl. 2 klemmen)\*
- 180 x 40cm (excl. 2 klemmen)\*
- 200 x 40cm (excl. 2 klemmen)

\* Uit voorraad leverbaar met rechte hoeken in Glass EJ004 en Lead EJ104



Voorzetwanden Mute (bxh) wandhoogte 40cm boven blad

- 140 x 65cm (excl. 2 klemmen)
- 160 x 65cm (excl. 2 klemmen)
- 180 x 65cm (excl. 2 klemmen)
- 200 x 65cm (excl. 2 klemmen)



Benchwanden Mute (bxh)

- 140 x 80cm (excl. 2 klemmen)
- 160 x 80cm (excl. 2 klemmen)\*
- 180 x 80cm (excl. 2 klemmen)\*
- 200 x 80cm (excl. 2 klemmen)

\* Uit voorraad leverbaar met rechte hoeken in Glass EJ004 en Lead EJ104

Klemmen



Mute opzetklem 401 in wit, alu en zwart (tbv opzetwand 40cm hoog)



Mute voorzetklem 405 in wit, alu en zwart (tbv voorzetwand 65cm hoog)



Mute benchklem 411 magnetisch in wit, alu, shadow grey en zwart (tbv benchwand 80cm hoog)

Camira Cara voorraad kleuren



Meerdere kleuren, maatvoeringen en stofsoorten op aanvraag leverbaar.





Basic+ wanden zijn vervaardigd van gerecyclede bureaubladen met een akoestische kern van gerecyclede jeans stof. Leverbaar in Camira Cara of Fabraa I-stoffering (Soil). Uit voorraad leverbaar in diverse maten in Cara Lead of Glass.



Basic+ opzetwand met rechte hoeken uit voorraad leverbaar.



Basic+ opzetwand met afgeronde hoeken op bestelling leverbaar (4-6 wk)



De Basic+ is vervaardigd van gerecyclede 25mm dikke bureaubladen waar de kern uit wordt gefreesd om die weer op te vullen met gerecyclede jeans, hoe duurzaam wilt u het hebben!



Opbouw akoestische wanden

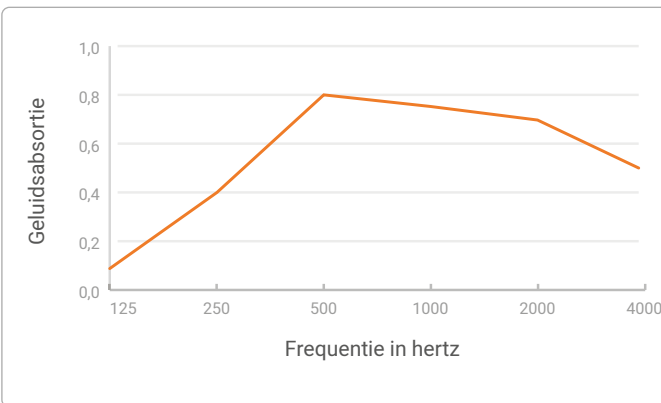

Wat is het akoestische effect?

Elk materiaal heeft een absorptiewaarde variërend van 0 tot 1, waarbij 0 de geluidsgolven volledig weerkaatst (denk aan glas) en 1 volledig absorbeert.

Basic+ scheidingswand



Opzetwanden Basic+ (bxh) wandhoogte 35cm boven blad

- 140 x 40cm (excl. 2 klemmen)
- 160 x 40cm (excl. 2 klemmen)\*
- 180 x 40cm (excl. 2 klemmen)\*
- 200 x 40cm (excl. 2 klemmen)

\* Uit voorraad leverbaar met rechte hoeken in Glass EJ004 en Lead EJ104



Voorzetwanden Basic+ (bxh) wandhoogte 40cm boven blad

- 140 x 65cm (excl. 2 klemmen)
- 160 x 65cm (excl. 2 klemmen)
- 180 x 65cm (excl. 2 klemmen)
- 200 x 65cm (excl. 2 klemmen)



Benchwanden Basic+ (bxh)

- 140 x 80cm (excl. 2 klemmen)
- 160 x 80cm (excl. 2 klemmen)\*
- 180 x 80cm (excl. 2 klemmen)\*
- 200 x 80cm (excl. 2 klemmen)

\* Uit voorraad leverbaar met rechte hoeken in Glass EJ004 en Lead EJ104

Klemmen



Basic+ opzetklem 701 in wit, alu en zwart (tbv opzetwand 40cm hoog)



Basic+ voorzetklem 701 in wit, alu en zwart (tbv voorzetwand 65cm hoog)



Basic+ benchklem 711 magnetisch in wit, alu en zwart (tbv benchwand 80cm hoog)

Camira Cara voorraad kleuren



Meerdere kleuren, maatvoeringen en stofsoorten op aanvraag leverbaar.





## ECO-screen 9mm

De 9mm ECO-screen zichtschootten en opzetwanden zijn vervaardigd uit gerecyclede PET flessen en leverbaar in 33 kleuren! Model met afgeronde hoeken en optioneel te voorzien van gefreesde v-groeven. Overige maatvoeringen op aanvraag.

**55** 55 PET flessen per m2

### Opzetwanden ECO-screen 9mm

- ECO-screen 9 opzetwand 140 x 40cm (incl. 2 klemmen)
- ECO-screen 9 opzetwand 160 x 40cm (incl. 2 klemmen)
- ECO-screen 9 opzetwand 180 x 40cm (incl. 3 klemmen)
- ECO-screen 9 opzetwand 200 x 40cm (incl. 3 klemmen)

### Zichtschootten ECO-screen 9mm

- ECO-screen 9 zichtschoot 140 x 40cm (incl. beugels)
- ECO-screen 9 zichtschoot 160 x 40cm (incl. beugels)
- ECO-screen 9 zichtschoot 180 x 40cm (incl. beugels)
- ECO-screen 9 zichtschoot 200 x 40cm (incl. beugels)

### Optie

V-groef éénzijdig

De zichtschootbeugels zijn uitgevoerd in zwart met witte, zwarte of chromen kapje, de bladklemmen voor de opzetwanden zijn leverbaar in zwart, aluminium of wit.

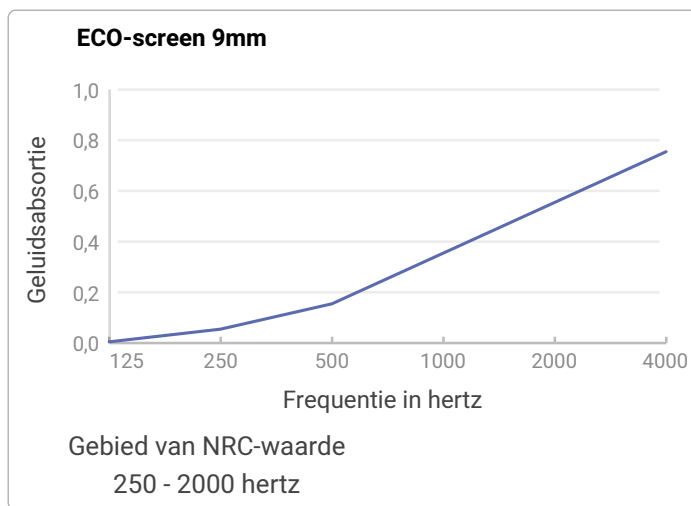

### Kleuren 9mm





## ECO-scherm 18mm

ECO-scherm in 18mm dik met uitstekende akoestische absorptiewaarde is leverbaar in 4 kleuren en optioneel te voorzien van elegante v-groef in opzetwand 40cm en voorzetwand 59cm waarvan 45cm boven werkblad. Overige maatvoeringen op aanvraag.



120 PET flessen per m<sup>2</sup>

### Opzetwanden ECO-scherm 18mm

- ECO-scherm 18 opzetwand 140 x 40cm (incl. 2 klemmen)
- ECO-scherm 18 opzetwand 160 x 40cm (incl. 2 klemmen)
- ECO-scherm 18 opzetwand 180 x 40cm (incl. 3 klemmen)
- ECO-scherm 18 opzetwand 200 x 40cm (incl. 3 klemmen)

### Voorzetwanden ECO-scherm 18mm

- ECO-scherm 18 voorzetwand 140 x 59cm (incl. 2 klemmen)
- ECO-scherm 18 voorzetwand 160 x 59cm (incl. 2 klemmen)
- ECO-scherm 18 voorzetwand 180 x 59cm (incl. 3 klemmen)
- ECO-scherm 18 voorzetwand 200 x 59cm (incl. 3 klemmen)

### Opties

- V-groef éénzijdig
- V-groef tweezijdig

De bladklemmen voor de opzetwanden en voorzetwanden zijn leverbaar in zwart, aluminium of wit.

### Kleuren 18mm

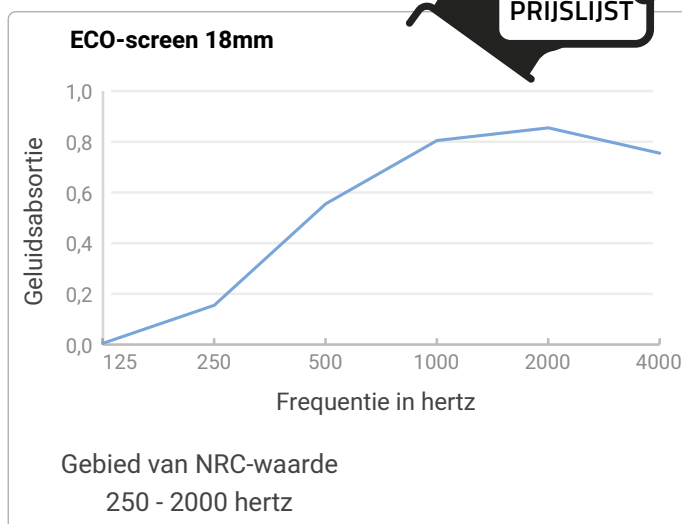
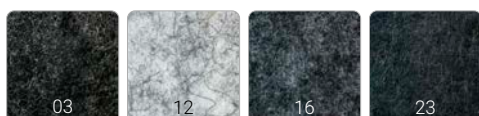



Bureau Flex 3+ bench 160

## ECO-screen bench 18mm

ECO-screen bench in 18mm dik is ideaal voor de akoestische scheiding van uw duowerkplekken. Middels de unieke magnetische benchrail is de wand eenvoudig zonder gereedschap te plaatsen op de benchpoot. Rail leverbaar in wit, zwart of alu en wand in 4 kleuren PET paneel.



120 PET flessen  
per m<sup>2</sup>

### Eco-screen benchwanden 18mm

ECO-screen 18 benchwand 160 x 80cm (incl. benchrail)

ECO-screen 18 benchwand 180 x 80cm (incl. benchrail)

ECO-screen 18 benchwand 200 x 80cm (incl. benchrail)

Overige maatvoeringen op aanvraag

### Opties

V-groef éénzijdig

V-groef tweezijdig

2 x 9mm PET wand (ipv 18mm)  
(kleuren 9mm zie pag 106 /  
levertijd 3-4 weken)

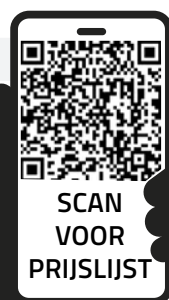

Sterke magneten  
houden de wand  
perfect op zijn plaats

### Kleuren 18mm

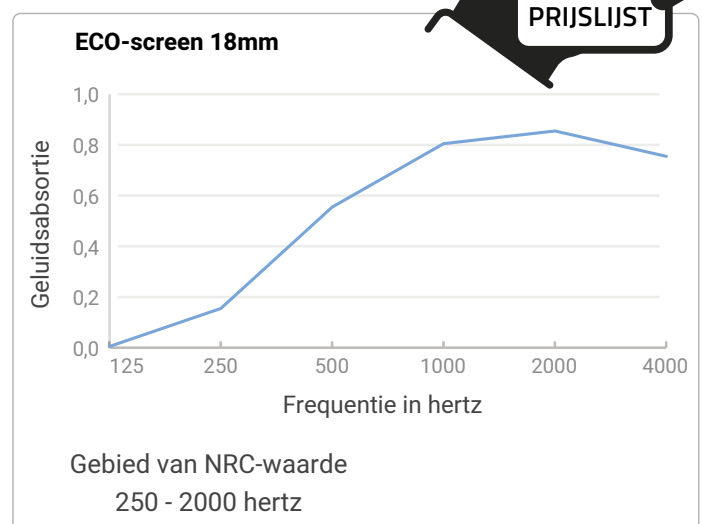
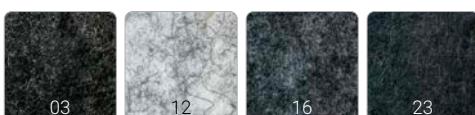

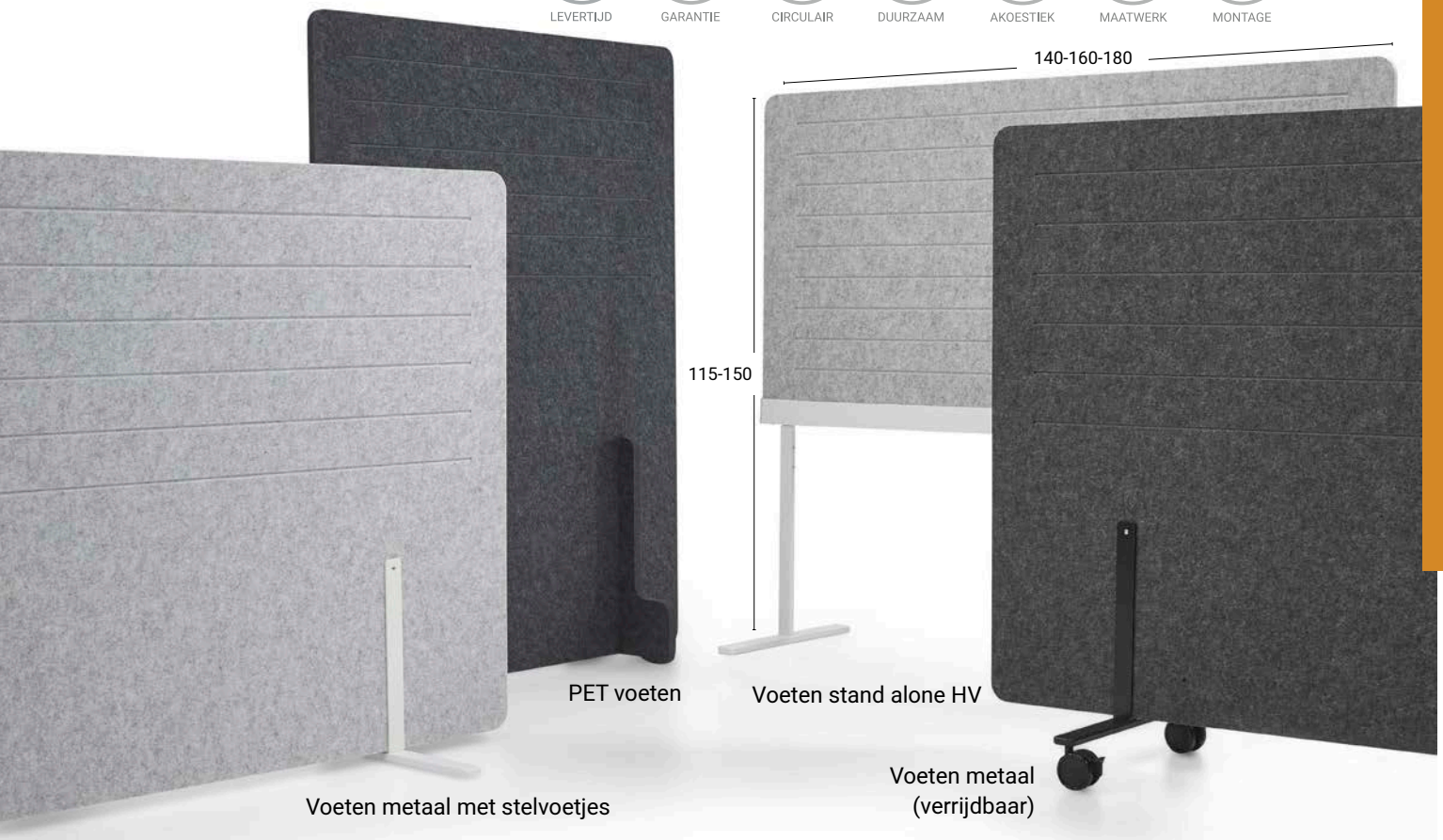

## ECO-screen vrijstaand 25mm

Uitgevoerd in 25mm dik PET akoestisch paneel is de ECO-screen vrijstaand een ideale en flexibele oplossing voor elke ruimte. Deze vrijstaande wanden zijn tot op de grond gesloten. In diverse afmetingen en uitvoeringen leverbaar.



145 PET flessen per m<sup>2</sup>

Kleuren 25mm



### Eco-screen 25mm vrijstaand

ECO-screen 25 vrijstaand 140 x 120h

ECO-screen 25 vrijstaand 160 x 120h

ECO-screen 25 vrijstaand 180 x 120h

ECO-screen 25 vrijstaand 120 x 160h

ECO-screen 25 vrijstaand 120 x 180h

ECO-screen 25 vrijstaand 120 x 200h

Overige maatvoeringen op aanvraag

### Opties

V-groef éénzijdig

V-groef tweezijdig

Voeten metaal plat in wit, alu of zwart

Voeten metaal met stelvoetjes in wit, alu of zwart

Voeten metaal verrijdbaar in wit, alu of zwart

Voeten in 25mm PET (standaard)



## ECO-screen Stand alone 18mm

De Stand alone wanden staan op een HV onderstel (hoogte 115-150cm) en zijn uitgevoerd in 18mm PET akoestisch materiaal netjes passend in de verstevigde aluminium rail. De 18mm PET wand is in 4 kleuren leverbaar (zie pag 108) en de metalen platte voet met rail zijn mogelijk in wit, alu of zwart.

### ECO-screen Stand alone 18mm

ECO-screen 18 Stand alone 140 x 59h (HV 115-150cm)

ECO-screen 18 Stand alone 160 x 59h (HV 115-150cm)

ECO-screen 18 Stand alone 180 x 59h (HV 115-150cm)

ECO-screen 18 Stand alone 200 x 59h (HV 115-150cm)

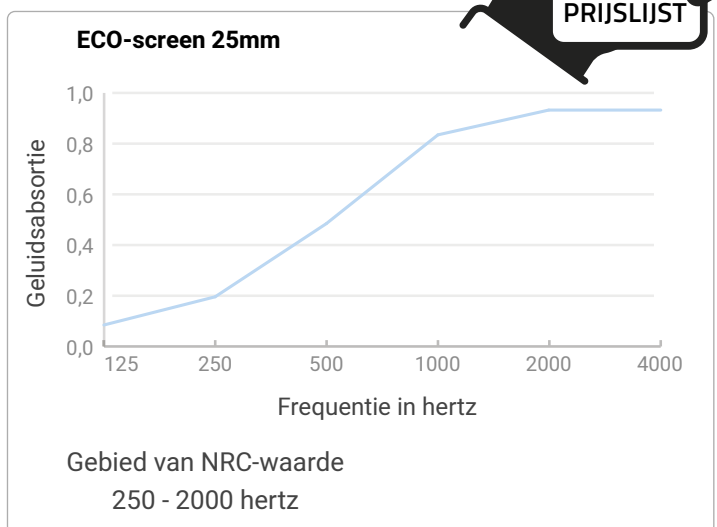



140 - 200



Mute wanden hebben een sterk houten kader met een akoestische kern van gerecyclede jeans stof. Leverbaar in Camira Cara of Fabraa I-stoffering (Soil). Kies voor diverse voeten en koppelsystemen.



Opbouw akoestische wanden



Metalen voet



Metalen voet met wielen

Mute vrijstaande wand (bxh in cm)

- 100 x 180 cm (excl. voeten)
- 100 x 200 cm (excl. voeten)
- 120 x 180 cm (excl. voeten)
- 120 x 200 cm (excl. voeten)
- 160 x 180 cm (excl. voeten)
- 160 x 200 cm (excl. voeten)
- 180 x 180 cm (excl. voeten)
- 180 x 200 cm (excl. voeten)
- 140 x 65 cm (excl. verhoogde ringvoet 60 hoog)
- 160 x 65 cm (excl. verhoogde ringvoet 60 hoog)
- 180 x 65 cm (excl. verhoogde ringvoet 60 hoog)
- 200 x 65 cm (excl. verhoogde ringvoet 60 hoog)

(leverbaar met rechte of ronde hoekafwerking)

Voeten

- Set platte metalen voeten (zwart of wit)
- Set metalen voeten met wielen (zwart of wit)
- Metalen ringvoet 60cm hoog (zwart of wit)

Opties

- Magnetisch koppelsysteem aan 1 zijde per wand
- Magnetisch koppelsysteem aan 2 zijden per wand
- Sleutelgatverbinding per koppeling

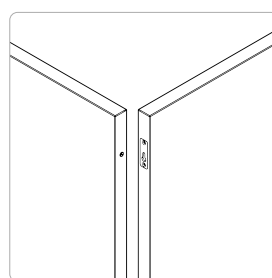

Sleutelgatverbinding

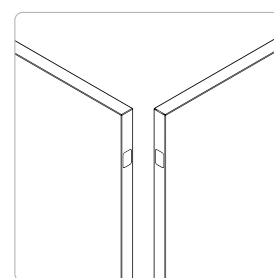

Magnetisch koppelsysteem

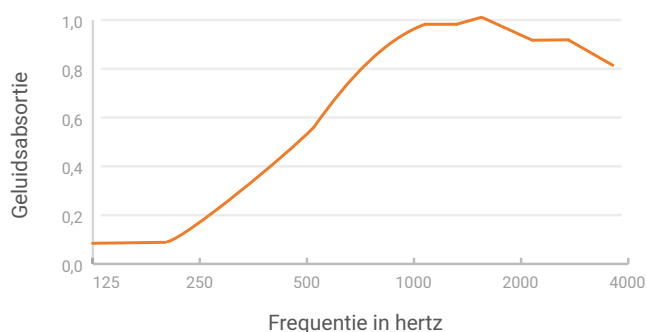

Wat is het akoestische effect?

Elk materiaal heeft een absorptiewaarde variërend van 0 tot 1, waarbij 0 de geluidsgolven volledig weerkaatst (denk aan glas) en 1 volledig absorbeert.

— Mute scheidingswand



Eco-light lampen zijn duurzaam geproduceerd van PET akoestisch materiaal en in 33 kleuren leverbaar.

De tafellamp is standaard voorzien van E27 fitting en stoffen stekkersnoer met handschakelaar. De hanglampen zijn uitgevoerd met een E27 fitting en stoffen snoer met plafondrozet.

Deze eye-catcher zorgt voor de nodige sfeer in ieder interieur!



Eco-light hanglamp L, XL en M



Eco-light Horizon hanglamp 140cm

#### Eco-light PET kleuren

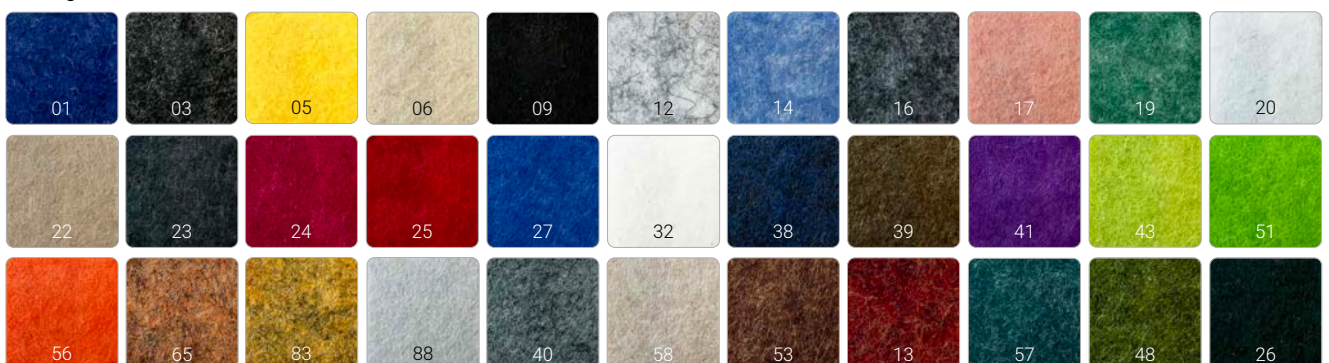



Eco-light tafellamp S



**Eco-light modellen**

Eco-light tafellamp S doorsnede 16cm H25cm (incl. snoer, excl. lichtbron E27)

Eco-light tafel- of hanglamp M doorsnede 30cm H28cm (incl. snoer, excl. lichtbron E27)

Eco-light tafel- of hanglamp L doorsnede 44cm H41cm (incl. snoer, excl. lichtbron E27)

Eco-light tafel- of hanglamp XL doorsnede 58cm H52cm (incl. snoer, excl. lichtbron E27)

Eco-light 3-poots staande lamp M doorsnede 30cm H130cm (incl. snoer, excl. lichtbron E27)

Eco-light Horizon hanglamp met doorsnede 14cm en lengte 140cm (incl. snoer en LED lichtbron 3000K)



Eco-light tafellamp L, XL en M



Eco-light 3-poots staande lamp M



## PLANET

Elegante lichtcirkels die uw ruimte vullen met sfeer. Leverbaar in 3 maten (70, 90 of 110cm) en 4 kleuren. Het slanke armatuur is uitgevoerd in duurzaam aluminium en voorzien van LED verlichting in warm wit (2700K) met soft diffuser.

Stel zelf uw groep samen met de gewenste specificaties en creëer een prachtig lichtobject voor uw ruimte.



**Quadrifoglio Group**

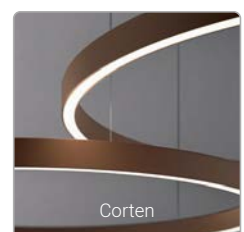
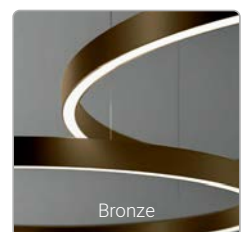

### Model

Planet 70

Planet 90

Planet 110





Staande lamp CD LED 104cm hoog

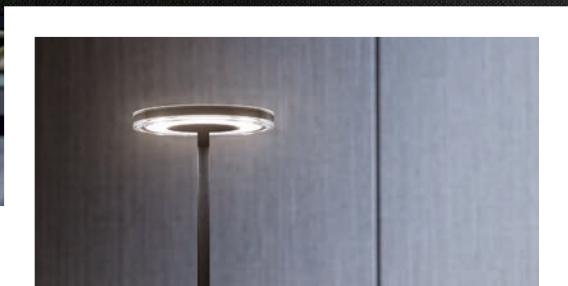

CD LED hanglamp

CD LED tafellamp



CD LED wandlamp met 3 vormen  
PMMA ring

CD LED kleuren PMMA ring



Transparent

Blue

Light blue

Green

Red

Orange

Yellow

## CD LED

CD LED, ontworpen door Moreno di Giorgio, is een fraaie serie sfeerverlichting met ongekeerde mogelijkheden.

Staande lampen, tafellampen en hanglampen in diverse uitvoeringen, voor iedere ruimte een passende oplossing.





Staande lamp met kap in stof naturel linnen.



## GRACE

Design van Moreno di Giorgio, de lampenkap in een nieuw jasje! Geef uw ruimte extra sfeer met de vele mogelijkheden van de Grace.

### Grace framekleuren

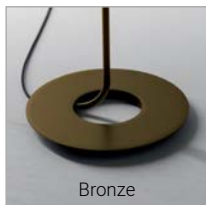

Bronze

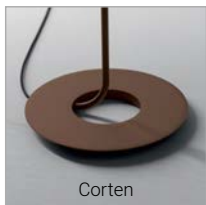

Corten



Black

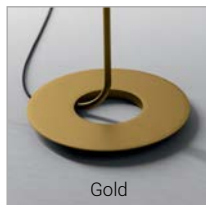

Gold



Grace tafellamp in zwart katoen



Grace hanglamp 50cm





Afra staande lamp wit

# AFRA

Ontworpen door Enrico Franzolini, die ze beschrijft als lichtgevende parels! Handgeblazen glazen globes, modern en verrassend, brengen elk interieur tot leven.



Afra hanglamp



Afra tafellamp wit



Zorg dat uw kabels netjes weggewerkt worden met het juiste kabelmanagement pakket. Om de werkplek optimaal uit te rusten bieden wij u een ruime keuze aan accessoires voor het werkblad, de monitor en computer (CPU).

### Kabelgrips



#### Kabelbeugel enkel

lengte 76mm t.b.v. 8 kabels.  
Kleur: lichtgrijs en zwart

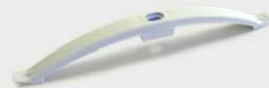

#### Kabelbeugel dubbel

lengte 177mm t.b.v. 16 kabels.  
Kleur: lichtgrijs en zwart



#### Kabelgrip klein

afmeting 110x65mm voorzien van 4 lussen,  
in zwart, wit en zilver



#### Kabelgrip groot

afmeting 155x65mm voorzien van 6 lussen,  
in zwart, wit en zilver



Kabelmanagement onder de werkplek



VOORRAAD



GARANTIE



MONTAGE

**Kabeldoorvoerdoppen**



**Kabeldoorvoerdop kunststof**  
boorgat 60mm zwart, wit en zilver  
boorgat 80mm zwart, wit en zilver



**Kabeldoorvoerdop metaal**  
boorgat 60mm  
boorgat 80mm  
In kleuren zwart, wit, alu ral 9006, chroom gepolijst, chroom mat en rvs finish met borstel zwart



**Kabelslangen**



**Kabelslang PP rechthoekig,**  
Leverbaar in sets voor diverse hoogtes, compleet met verzwaarde voetplaat, bladbevestiging en leverbaar in zwart, alu en wit

Slang rechthoekig 760mm  
23-delig (effectief 810mm)

Slang rechthoekig 1260mm  
38-delig (effectief 1310mm)

Los segment

Magneet aanklembaar  
(zwart, alu of wit)



Kabelslang  
PP rechthoekig

**Kabelgoten**



**Flexy kabelgoot**  
Inclusief montagebeugels.  
Leverbaar in zwart, wit en zilver.

600mm 1000mm

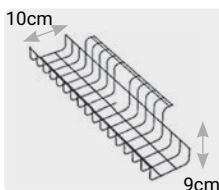

**Kabelkorf**  
Metalen draadkorf.  
Leverbaar in zwart, wit en zilver.

490mm 790mm



**Sun kabelgoot**  
Metalen kabelgoot.  
Leverbaar in zwart, wit en aluminium.

500mm 1100mm 1470mm



**Turn kabelgoot**  
Metalen kabelgoot voorzien van ophangbeugels (hoogte in 4 standen verstelbaar)

490mm	790mm	1150mm	1450mm	1750mm
in wit en alu	in zwart, wit en alu	in zwart, wit en alu	in zwart, wit en alu	in zwart, wit en alu

## Losse componenten

### Stekkerdozen en stroomsnoeren



#### Stekkerdozen

3x stroom  
4x stroom  
5x stroom  
6x stroom

#### Aansluitsnoer\*

1 meter  
2 meter  
3 meter  
4 meter  
5 meter

#### Koppelsnoer\*

1 meter  
2 meter  
3 meter  
4 meter  
5 meter

\*Andere lengtes op aanvraag.

## Op- en inbouwmodules

### Power Desk Up 2.0

is een elektrificatie opbouwmodule voorzien van stroom met als optie USB chargers en/of data- en multimedia aansluitingen (zelf naar wens samen te stellen).

De Power Desk Up wordt met bladklemmen aan het blad gemonteerd.

Voorzien van 1m kabel met eGST plug.

(Let op, nog aansluitsnoer toevoegen)

Leverbaar in de kleur zwart of wit.



### Modellen:

1x Stroom + Usb Charger (A+C)  
(Met 1,5 meter eGST plug)

1x Stroom + Usb Charger (A+C) 30w

2x Stroom\*

2x Stroom + 1x Leeg

2x Stroom + 2x Usb-A Charger\*

2x Stroom + Usb Charger (A+C)\*

2x Stroom + Usb Charger (A+C) 30w

2x Stroom + 2x usb-A Charger + 1x leeg\*

2x Stroom + Usb Charger (A+C) + 1x leeg\*

2x Stroom + Usb Charger (A+C) 30w + 1x leeg

3x Stroom

3x Stroom + Usb Charger (A+C)

De lege moduleplaats kan naar wens gevuld worden met :

Data CAT6A, USB3.0, HDMI2.0, USB-C data

\*Ook in BE/FR uitvoering





VOORRAAD



GARANTIE



MONTAGE

**Power Spot**

is een compacte elektrificatie inbouwmodule met directe toegang.

Power Spot is leverbaar in 2 kleuren: zwart en wit

Ø60mm boorgat



1x stroom + 1x USB A en C charger en USB C data extension. Met een aansluitsnoer van 1,7 meter met randaarde stekker of met een eGST plug.

(ook in BE/FR uitvoering)

**Spot Plus**

is een elektrificatie inbouwmodule met een klapdeksel voorzien van 1x stroom, 1x USB-A + USB-C charger en 1x kabeltunnel met een draadloze oplader aan de binnenzijde van de deksel.

Ø80 mm boorgat.



1x stroom, 1x USB A + C charger en 1x kabeltunnel\* zwart of wit (inclusief 1,9 meter aansluitsnoer)

\* De kabeltunnel is te vervangen door:  
data CAT6a  
USB 3.0 (data)  
HDMI

(ook in BE/FR uitvoering)

**Power Desk IN**

Mooie inbouw oplossing die d.m.v. een push-to-open kan worden geopend (inbouwdikte tot 50mm).

Verkrijgbaar in de kleur zwart of wit.

Met 1 meter vaste kabel met eGST plug.



2x Stroom + USB A+C Charger  
2x Stroom + USB-A+C Charger + 1x Leeg  
3x Stroom  
3x Stroom + 1x Keystone  
3x Stroom + USB A+C Charger

**Powercube**

De PowerCube is standaard wit met diverse gekleurde wandcontactdozen. (groen, blauw, grijs en rood) PowerCube is horizontaal, verticaal en upside-down te monteren met de bijgeleverde "twist & lock" bevestiging. (Incl. 1,5m aansluitsnoer)



5x stroom + 1,5m vast aansluitsnoer

4x stroom + 2x USB-A charger + 1,5m vast aansluitsnoer

3x stroom + 2x USB-A charger en 1x USB-C charger + wireless charger met 1,5 meter aansluitsnoer (leverbaar in zwart of wit)

## CPU-houder TH02

**TH02**

Zeer functionele en eenvoudig te bedienen CPU houder geschikt voor de meest gangbare maten. Onder uw bureaublad te monteren. Leverbaar in de kleuren: zwart, wit en zilver.

Breedte instelbaar 70 - 230mm  
Hoogte instelbaar 310 - 555mm  
Max. draagvermogen 30kg.

**TH02 Thinclient**

De Thin Client houder is speciaal voor de wat kleinere computers. In te stellen in een gewenste hoogte: 165-320mm en breedte: 30-110mm. Leverbaar in de kleuren: zwart, wit en zilver.

Breedte instelbaar 30 - 110mm  
Hoogte instelbaar 165 - 320mm  
Max. draagvermogen 30kg.



## Monitorarm Focus

**Focus monitorarm**

De Focus monitorarm is een modern vormgegeven monitorarm. De arm is in een handomdraai geïnstalleerd. Door het slimme ontwerp is hij erg gunstig geprijsd maar wel gebouwd volgens de laatste ergonomische eisen. De Focus arm is traploos in hoogte verstelbaar en standaard geleverd met bladdoorvoer en bladklem (10-88mm bladdikte)

## Specificaties:

- Draagvermogen max 8kg
- Traploos in hoogte verstelbaar
- Standaard voorzien van een universele Quick Release VESA
- Voorzien van een anti-diefstal lock
- Leverbare kleuren zwart, wit en zilver
- Met handig kabelmanagementsysteem
- Standaard met bladklem en doorboorklem



Focus enkel  
kleuren zwart, wit en zilver  
Geschikt voor 13-32 inch monitoren



Focus dubbele knikarm  
kleuren zwart, wit en zilver  
Geschikt voor 13-27 inch monitoren



Focus duo met vaste bracket  
kleur zwart  
Geschikt voor 13-27 inch monitoren

## Monitorarm Galaxy

### Galaxy monitorarm

De modulaire Galaxy monitorarm met een max. draaggewicht van 16kg is middels losse onderdelen geheel naar wens samen te stellen.

Leverbaar in zwart, wit en zilver.



Enkel

Galaxy enkel kort  
kleuren: zwart, wit en zilver

Galaxy enkel  
kleuren: zwart, wit en zilver

Galaxy dubbel  
kleuren: zwart, wit en zilver

### Galaxy gasveer monitorarm

Deze set heeft een draagkracht van 2-12kg

- Leverbaar in zwart, zilver en wit
- VESA voorzien van quick release.
- Ook leverbaar in een versie met twin bracket voor 2 monitoren.



Dubbel

Galaxy triple  
kleuren: zwart, wit en zilver

Galaxy gasveer enkel  
kleuren: zwart, wit en zilver

Flex twin bracket + handgreep  
+ Vesa kogelgewricht  
zwart, wit en zilver  
(max. 2 x 27 inch monitor)



Gasveer

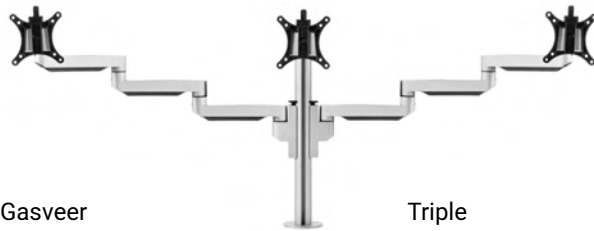

Triple

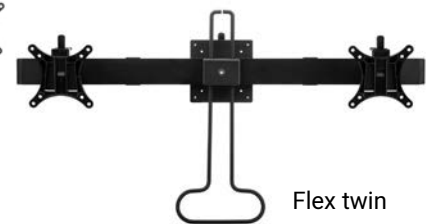

Flex twin

## Monitorarm Chicago

### Monitorarm Chicago

De Chicago gasgeveerde monitorarm is een dynamische monitorarm, vervaardigd uit gerecycled aluminium, met vele instel mogelijkheden voor een optimaal ergonomisch werkcomfort. Door het strakke design en de eenvoudige bediening is deze TFT monitorarm de perfecte aanvulling op elke werkplek.

Doordat de Filex Chicago voorzien is van een gasveer, is deze in te stellen voor bijna ieder gewicht scherm en daardoor voor de gebruiker eenvoudig in hoogte en diepte te verstellen. De Filex Chicago TFT arm wordt standaard geleverd met een Quick Release VESA (VESA 75x75 en 100x100). De bladklem wordt meegeleverd.

Doorboorklem is optioneel.

De Filex Chicago TFT is leverbaar in de kleuren wit, zwart, gepolijst alu en zilver/grijs. De Filex Chicago wordt geleverd met een gasveer van 2 tot en met 12 kg.



Chicago enkel (2-12kg)

Chicago enkel met bracket  
(2-12kg, max. 2 x 27 inch monitor)

Chicago dubbel (2-12kg)

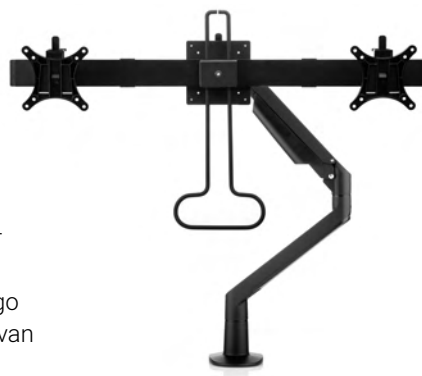





We vergaderen graag.

Om de tijd die we vergaderen zo effectief en prettig mogelijk te benutten, is het uiteraard van belang dat de inrichting van deze ruimte op een juiste manier wordt gedaan.

Een goede inrichting met de juiste meubelen kan bijdragen aan een efficiëntere vergadertijd.

Wij kunnen u helpen met passend advies en begeleiding om deze ruimte naar uw wens in te richten.



## Turn & Go

### Bestaande uit:

2x Turn & Go wit

2x blad Oak medium 180x80cm

1x koppelplaat

Getoonde stoelen: Classic+ visitor



Koppelplaat



Kunststof koppeling



Eenvoudig te ontgrendelen



Standaard voorzien van  
75mm grote wielen met rem.



De Turn & Go is een universele en zeer degelijke klaptafel met fraaie RVS T-poot voorzien van grote geremde wielen.

Het onderstel heeft een vaste afmeting en is geschikt voor bladen van minimaal 140x80 cm tot 200x80 cm.

Uit voorraad leverbaar in zwart/RVS en wit/RVS.

Onderstel	Bladmaat
Turn & Go klaptafel	140 x 80cm
Turn & Go klaptafel	160 x 80cm
Turn & Go klaptafel	180 x 80cm
Turn & Go klaptafel	180 x 90cm
Turn & Go klaptafel	200 x 80cm

Opties
Koppelplaat wit of zwart (55x11,5cm)
Kunststof koppeling per set 2 stuks

## Frame kleuren



### Blad groep 1 Melamine 25mm op voorraad

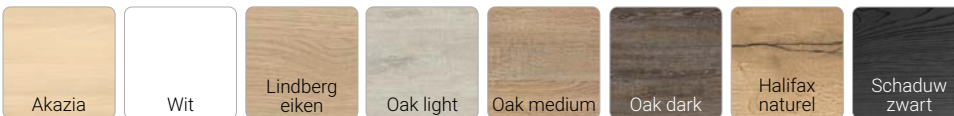

### Blad groep 2 Melamine 25mm op bestelling

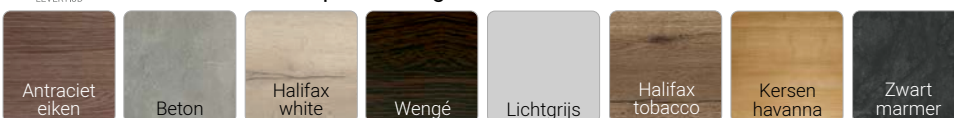

### Blad groep 3 Quadrifoglio melamine 25mm op bestelling

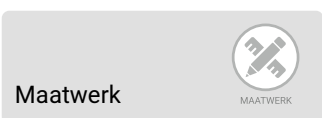
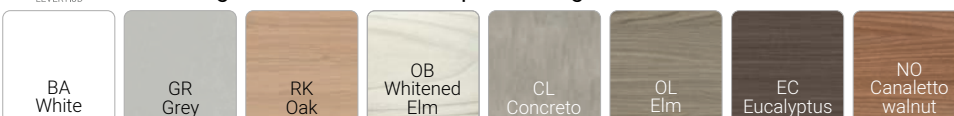

## Maatwerk

Ook maatwerk op aanvraag in elke gewenste maatvoering op bestelling leverbaar, rekening houdend met maximale plaatmaten (levertijd 4-6 weken).



**mara**<sup>®</sup>



Nivelleer eenvoudig uw bladen



Ontgrendeling in de bladdrager



Kunststof koppeling voor 2 tafels





Timmy-R klaptafels zijn zeer compact op te bergen

De Timmy-R klaptafel is extreem stevig door haar gelaste onderstel. Het mechaniek en de ontgrendelknop zijn netjes weggewerkt in het dragende H-frame voor optimale beenruimte en veiligheid. Uniek is de slimme nivelleerfunctie in de beide poten waarmee het blad versteld kan worden, ideaal bij meerdere tafels naast elkaar. Met de non-marking rubberen 60mm zwenkwielen die alle 4 een rem hebben zet u de tafel op de juiste plaats simpel vast.

Optioneel leverbaar met scharnierend zichtschoot en handige kunststof bladkoppeling.

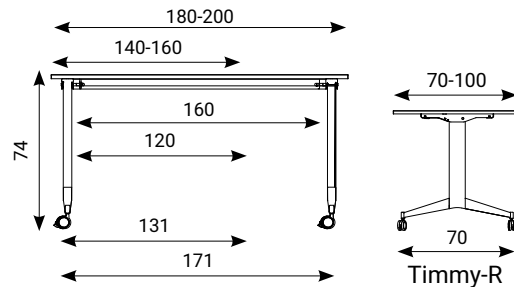

Onderstel	Bladmaat
Timmy-R 131	140 x 80cm
Timmy-R 131	160 x 80cm
Timmy-R 171	180 x 80cm
Timmy-R 171	180 x 90cm
Timmy-R 171	200 x 80cm
Timmy-R 171	200 x 100cm

**Opties**

- Chroom of antraciet onderstel
- Kunststof koppeling set a 2 stuks
- Zichtschoot
- Kabelgoot Sun of kabelgoot Flexy



**Metaalkleuren op voorraad**



**Metaalkleuren op bestelling (4-6 wk)**



**Blad groep 1  
Melamine 25mm op voorraad**

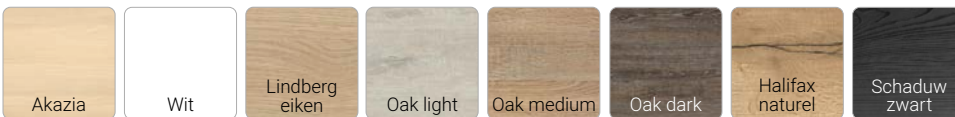

**Blad groep 2  
Melamine 25mm op bestelling**

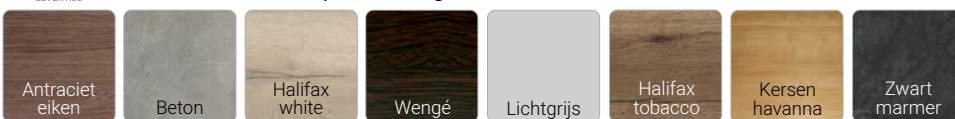

**Maatwerk**



**Blad groep 3  
Quadrifoglio melamine 25mm op bestelling**

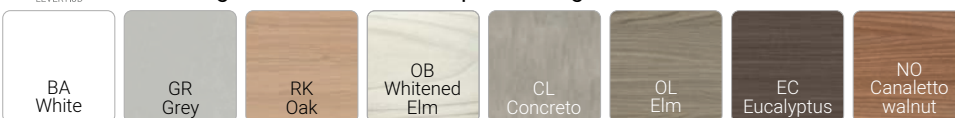

Ook maatwerk op aanvraag in elke gewenste maatvoering op bestelling leverbaar, rekening houdend met maximale plaatmaten (levertijd 4-6 weken).



Eenvoudig te koppelen



Bladveer- systeem voorkomt klemmen

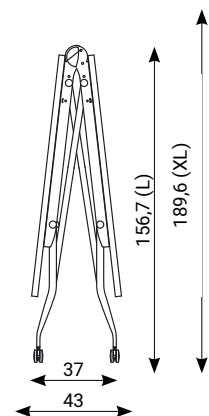
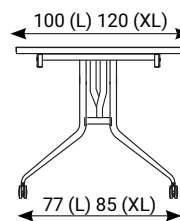
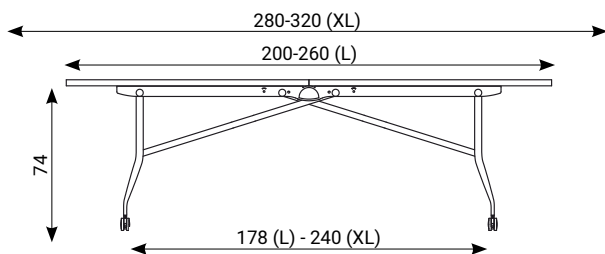



Argo Libro heeft een stabiel en elegant buizenframe met grote 75mm zwenkwielen voorzien van rem. Het frame is leverbaar in 2 varianten met een ruime keuze aan bladen voor uw ideale en flexibele vergadertafel.

Alle Argo Libro tafels zijn uitgevoerd met een veilig bladveersysteem wat vingerklemmen voorkomt.

Argo Libro is tevens leverbaar met de rechte, afgeronde én tonvormige Mara bladen in 10 kleuren melamine en 18 kleuren HPL.



Onderstel	Bladmaat (set)
Argo Libro L vouwtafel 200-260cm	200 x 80-100 / 260 x 80-100
Argo Libro L vouwtafel 280-320cm	280 x 80-100 / 320 x 80-100
Argo Libro XL vouwtafel 200-260cm	200 x 90-120 / 260 x 90-120
Argo Libro XL vouwtafel 280-320cm	280 x 90-120 / 320 x 90-120

Metaalkleuren



Bladkleuren Fenix 20mm



Bladkleuren HPL 20mm



Bladkleuren melamine 19mm

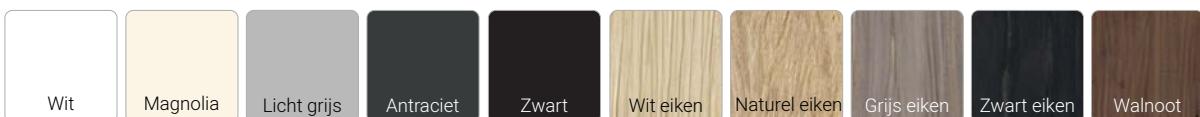

Bladkleuren melamine 25mm

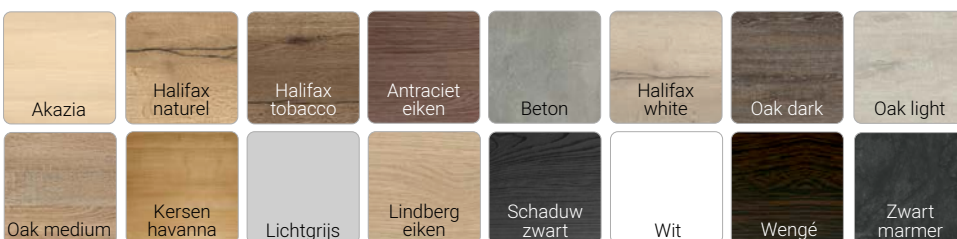

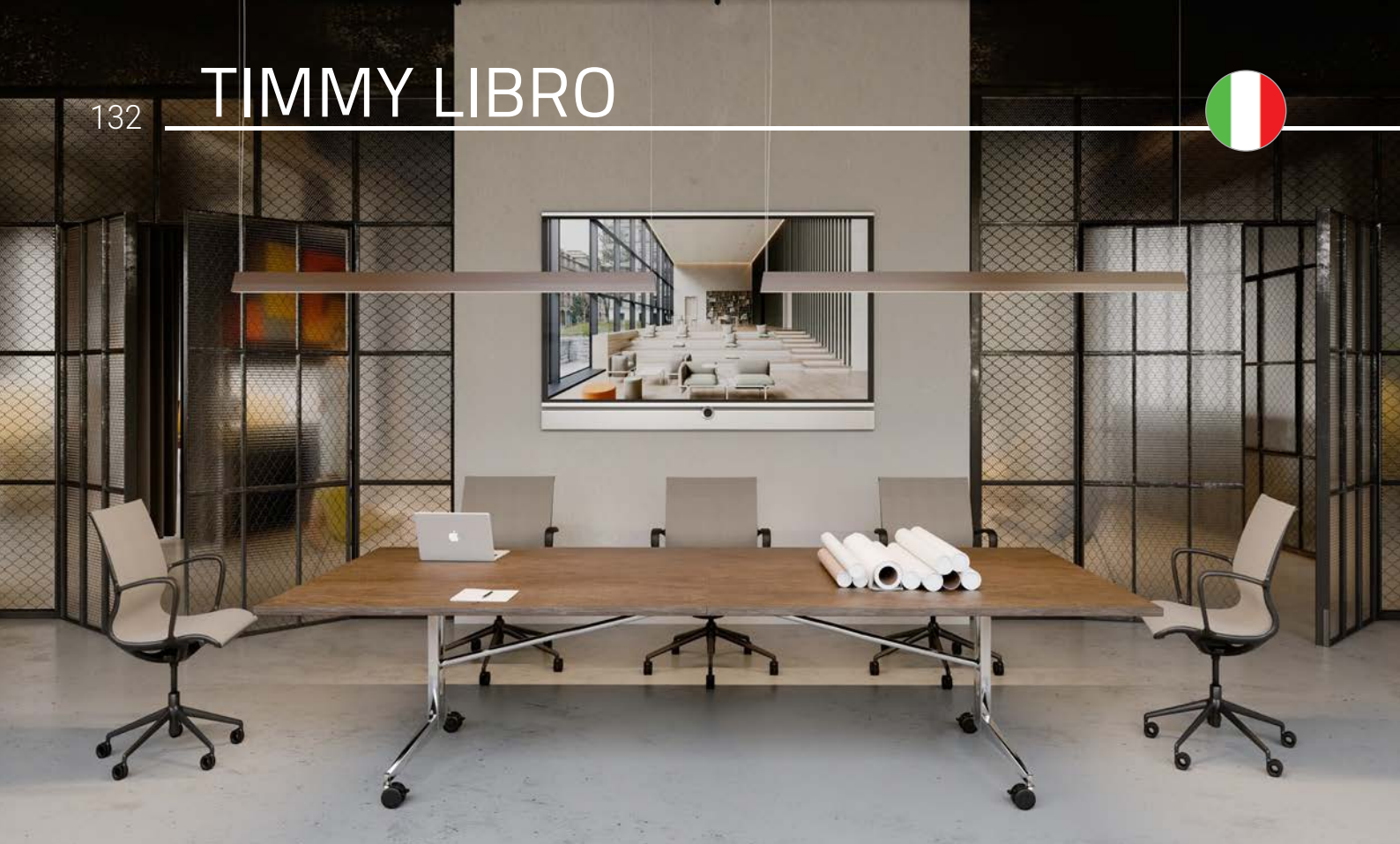

Eenvoudig te koppelen



Bladveer- systeem voorkomt klemmen



Timmy Libro hoog  
105 met bladmaat  
200x100cm



Timmy Libro met  
bladmaat 320x120cm

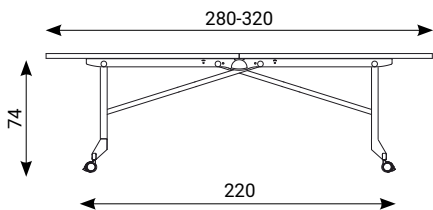

Timmy Libro

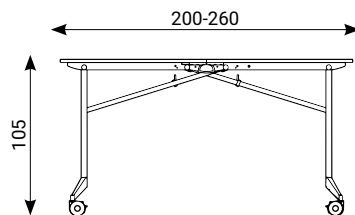
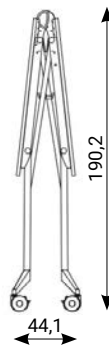
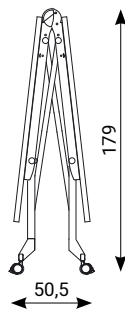
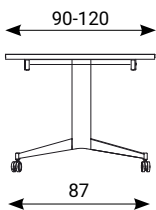

Timmy Libro 105h



Timmy Libro vouwtafel heeft een stoer, robuust frame voorzien van 10cm grote zwenkwielen met rem. De bladen hebben een zeer veilig bladveersysteem wat vingerklemmen voorkomt. Met de Timmy Libro 105H creëert u een statafel tot 260x120cm, verrijdbaar én opvouwbaar! Tevens leverbaar met de rechte, afgeronde én tonvormige Mara bladen.

Onderstel	Bladmaat (set)
Timmy Libro vouwtafel 200-260cm	200-260 x 90-120cm
Timmy Libro vouwtafel 280-320cm	280-320 x 90-120cm
Timmy Libro 105cm hoge vouwtafel 200-260cm	200-260 x 90-120cm



Gepatenteerd systeem



Frame gemonteerd geleverd



Metaalkleuren



Bladkleuren melamine 25mm

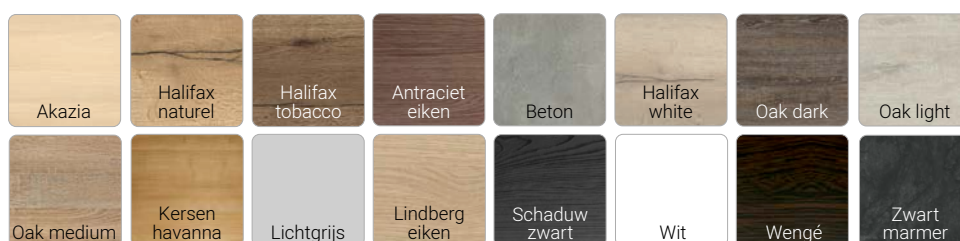

Bladkleuren Mara zie Argo Libro pagina 131

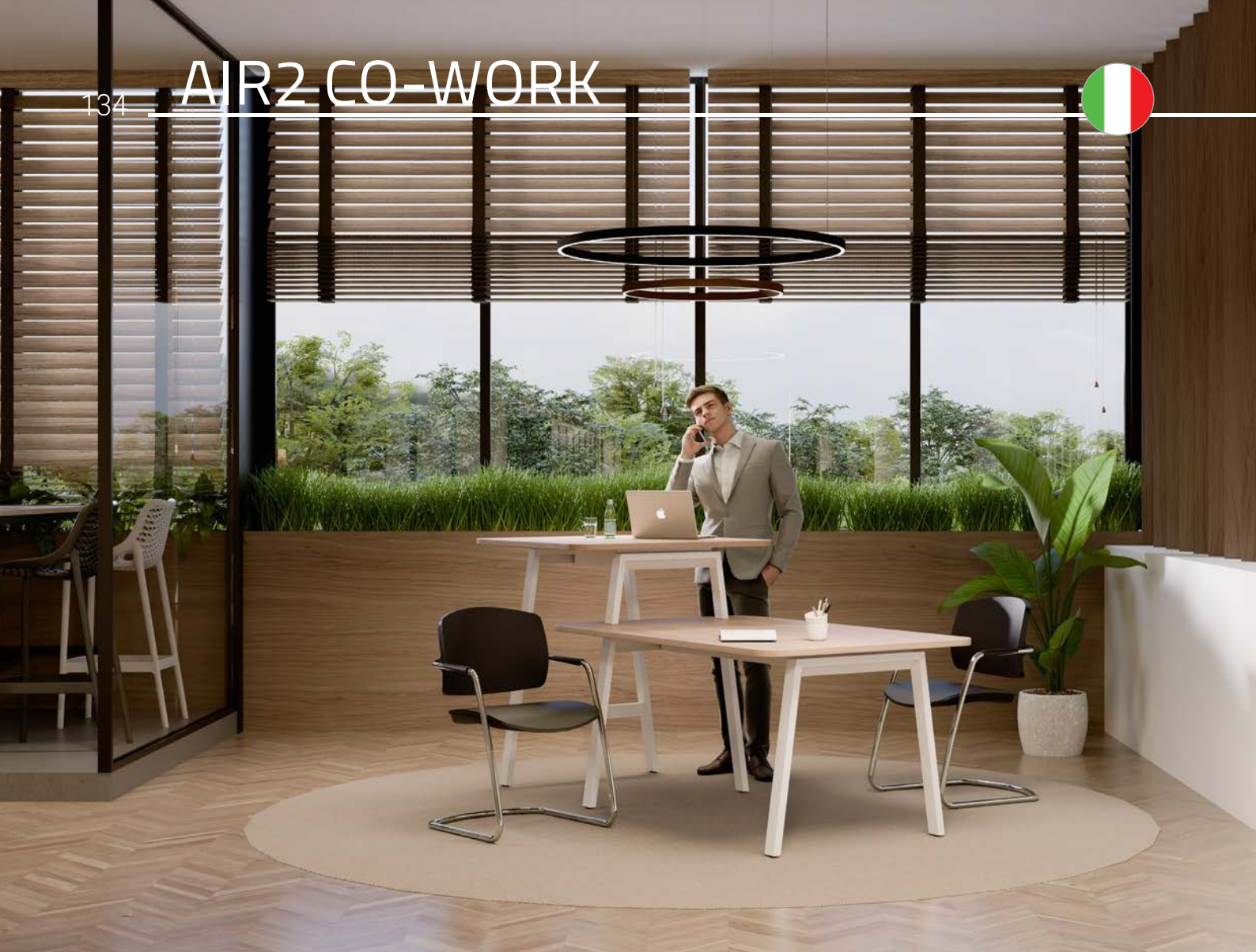

## Air2 Co-Work 260x120

### Bestaande uit:

Air2 100 wit set poten vaste hoogte  
 Kabelgoot lang 120/180 wit  
 Air2 Co-Work frame met hoge poot  
 en opzetpoot wit en 80cm beams  
 Bladen 120x120 en 180x120 in Oak  
 light en afgeronde hoeken  
 (totale lengte Air2 Co-Work: 260cm)

Getoond: Nuta Light met  
 armleggers en Nuta Light barkruk.





De Air2 Co-Work tafel combineert fijne werk- of vergaderplekken met een handige aanlandtafel. Ideaal om even staand te overleggen met een collega of gewoon aan te werken.

Het fraaie Air2 frame is leverbaar in zwart, wit en alu. Kies vervolgens uw bladkleur en maatvoering voor uw ideale Co-Work tafel en voeg desgewenst handige accessoires toe om het plaatje helemaal compleet te maken.

Het aanlandframe is 110cm hoog (incl blad 2,5cm) en leverbaar in 80, 160 en 200cm lang. De lage Air2 tafel heeft een handige telescopische kabelgoot waardoor een lengte tot wel 260cm kan worden bereikt.

**Air2 Co-Work laag modellen**

160 x 100 cm

180 x 120 cm

200 x 120 cm

240 x 120 cm

Kies voor rechte of afgeronde hoeken.

**Air2 Co-Work hoog modellen**

100 x 100 cm

120 x 120 cm

140 x 120 cm

Kies voor rechte of afgeronde hoeken.

**Opties**

Bladen met afgeronde hoeken

Diverse opbouw en inbouw modules



**Metaal kleuren**

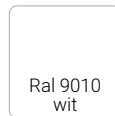
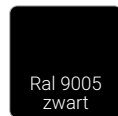

Voor handige inbouw- of opbouwunits zie pag.156

**Bladkleuren melamine 25mm**

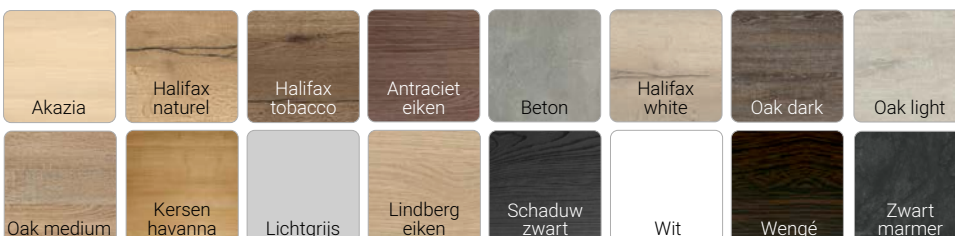

**Maatwerk**



Ook maatwerk op aanvraag in elke gewenste maatvoering op bestelling leverbaar, rekening houdend met maximale plaatmaten (levertijd 4-6 weken).



## Air2 meeting 480x160

### Bestaande uit:

Frame Air2 480x160cm kleur zwart  
3x blad 25mm 160x160cm kleur  
Halifax white

Getoonde stoel: PK slede.



Arca tafel 240 x 120 met maatwerk blad en inbouwunit, vraag naar de mogelijkheden voor uw ideale vergadertafel.

Getoonde stoel: Classic+ visitor

Air2 160 x 160  
Frame wit en blad 25mm Halifax naturel

Getoonde stoel: Slot Fill ringframe







VOORRAAD

4-6  
weken

GARANTIE



CONFIGUREERBAAR



MONTAGE



Entrada HI



Arca vaste hoogte



Air2 vaste hoogte



Combineer de diverse onderstellen en bladen tot de gewenste vergadertafel.  
Speciale bladvormen zijn in diverse maatvoeringen en kleuren op bestelling leverbaar.  
Optionele inbouwunits voor stroom en data op aanvraag mogelijk (zie pag. 156)

Model		Bestaand uit	Frame	Blad dikte
Rechthoek 180 x 90		2 poten kabelgoot XL	Entrada, Arca, Air2	25 mm 38 mm
Rechthoek 200 x 100		2 poten kabelgoot XL	Entrada, Arca, Air2	25 mm 38 mm
Deens ovaal 240 x 120		2 poten kabelgoot L	Entrada, Arca, Air2	25 mm
Vierkant 120 x 120		2 poten 120 kabelgoot L	Arca	25 mm 38 mm
Tafel 160 x 160		2 poten 160 2 kabelgoten L	Arca, Air2	25 mm 38 mm
Tafel 320 x 160		2 poten 160 1 poot intermediair 4 kabelgoten L	Arca, Air2	25 mm 38 mm
Tafel 480 x 160		2 poten 160 2 poten intermediair 6 kabelgoten L	Arca, Air2	25 mm 38 mm



VOORRAAD

## Blad groep 1

Melamine 25mm op voorraad

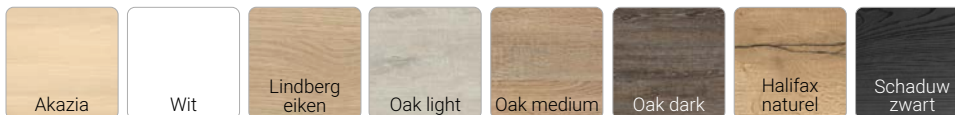
4-6  
weken

## Blad groep 2

Melamine 25mm op bestelling

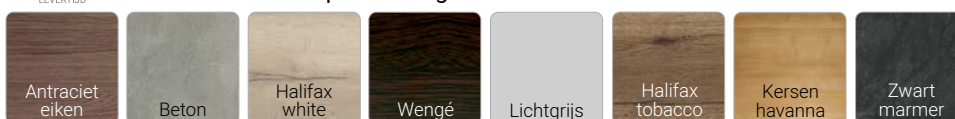
4-6  
weken

## Blad groep 3

Quadrifoglio melamine 25mm op bestelling

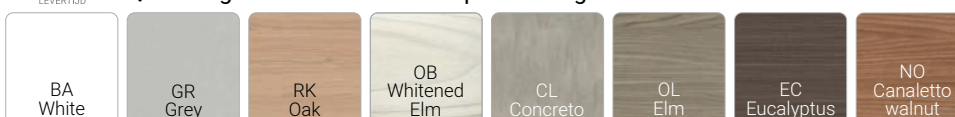

MAATWERK

## Maatwerk

Ook maatwerk op aanvraag in elke gewenste maatvoering op bestelling leverbaar, rekening houdend met maximale plaatmaten (levertijd 4-6 weken).

## Air2 en Arca bartafel

Vergaderen en lunchen op stahoogte 110cm met de zeer stabiele Air2 en Arca bartafels. Uitgevoerd in stevig kokerprofiel en uit voorraad leverbaar in diverse maten en kleuren.



Air2 bartafel 160 x 80cm  
Frame wit met Oak dark blad



Arca bartafel 160 x 60cm  
Frame wit met blad wit

### Air2 bartafel

Air2 bartafel 160 x 60 x 110h

Air2 bartafel 200 x 60 x 110h

Air2 bartafel 80 x 80 x 110h

Air2 bartafel 160 x 80 x 110h

Air2 bartafel 200 x 80 x 110h

### Arca bartafel

Arca bartafel 160 x 60 x 110h

Arca bartafel 200 x 60 x 110h

Arca bartafel 80 x 80 x 110h

Arca bartafel 160 x 80 x 110h

Arca bartafel 200 x 80 x 110h





VOORRAAD



LEVERTIJD



GARANTIE



MONTAGE



4-All 160x80 wit frame met wit blad.  
Getoonde stoelen: Maya

## 4-All kantinetafel

4-All is een veelzijdig inzetbare vierpoot tafel met 3 cm buisframe. Hoogte 76 cm en onderkant frame 70,5 cm.

### 4-All kantinetafel

80 x 80 cm

160 x 80 cm

200 x 80 cm



### Metaal kleuren

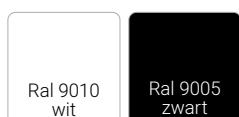

VOORRAAD

### Blad groep 1

Melamine 25mm op voorraad

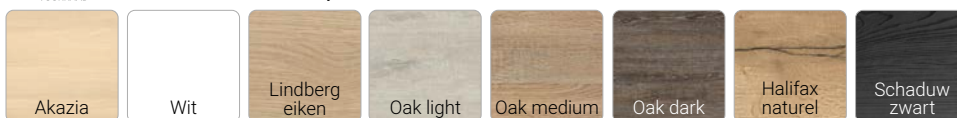

LEVERTIJD

### Blad groep 2

Melamine 25mm op bestelling

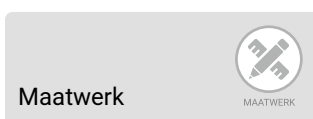
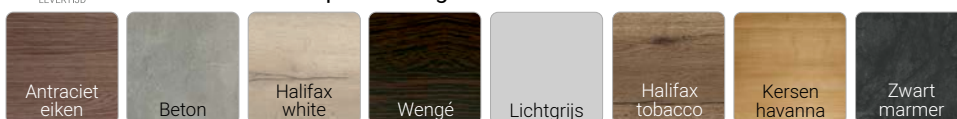

LEVERTIJD

### Blad groep 3

Quadrifoglio melamine 25mm op bestelling

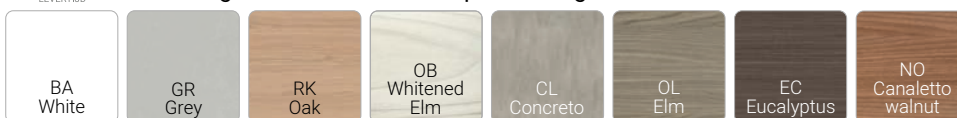

Ook maatwerk op aanvraag in elke gewenste maatvoering op bestelling leverbaar, rekening houdend met maximale plaatmaten (levertijd 4-6 weken).



Robuuste vergadertafels met veelzijdige mogelijkheden en oneindig door te koppelen. Met een bladdikte van 38mm en tafelhoogte 75cm. Stevige kolompoten (70x70mm) met stabiele bladdrager koppelen de losse bladsegmenten.

### Volledige opstellingen



MG1 EC 01

4 plaatsen



MG1 EC 32

6 plaatsen



MG1 EC 02

6/8 plaatsen



MG1 EC 33

(incl. 2 koppelplaten)

8 plaatsen



MG1 EC 04

(incl. 2 koppelplaten)

8/10 plaatsen



MG1 EC 34

(incl. 2 koppelplaat)

12 plaatsen

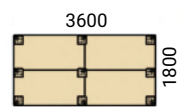

MG1 EC 05

(incl. 2 koppelplaten)

12/16 plaatsen



MG1 R160

6 plaatsen



MG1 R200

8 plaatsen

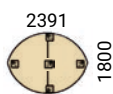

MG1 EC 12

8 plaatsen



MG1 EC 13

10 plaatsen



MG1 EC 37

(incl. 1 koppelplaat)

12 plaatsen



MG1 EC 14

(incl. 1 koppelplaat)

12/14 plaatsen

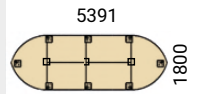

MG1 EC 38

(incl. 2 koppelplaten)

16 plaatsen

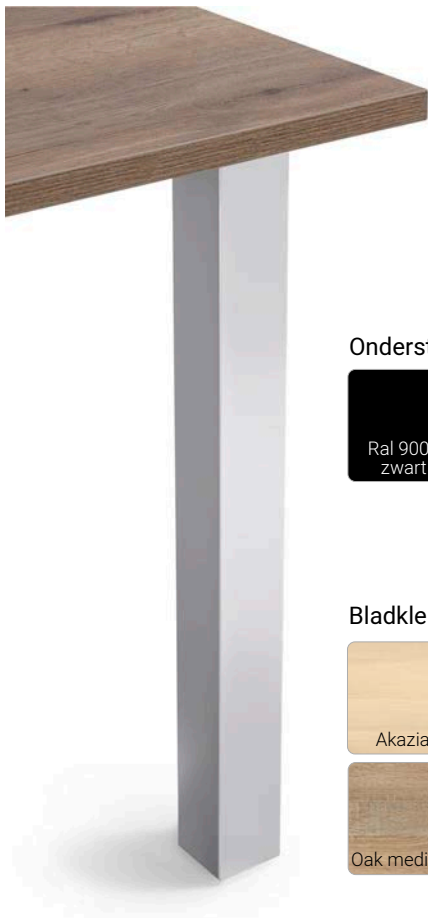

**Losse onderdelen**

TM1 losse poot wit 9010, alu 9006, shadow grey 7022 en zwart 9005  
TM1 koppelplaat 35x16cm zwart

Optionele inbouwunits voor stroom en data op aanvraag mogelijk (zie pag. 156)





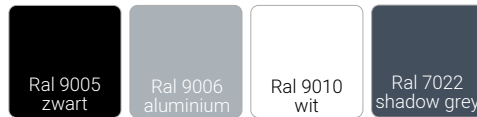

**Onderstel metaalkleuren**



**Bladkleuren melamine 38mm**

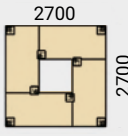
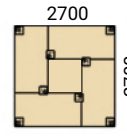

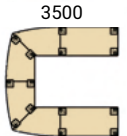
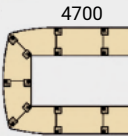
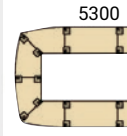
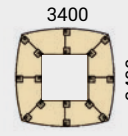
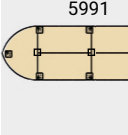
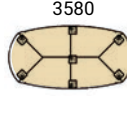
**Volledige opstellingen**

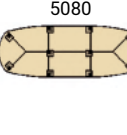
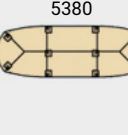
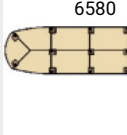
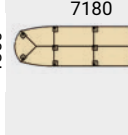
 <p>2700 2700</p> <p>MG1 EC 06 (incl. 4 koppelplaten) 16 plaatsen</p>	 <p>2700 2700</p> <p>MG1 EC 07 (incl. 4 koppelplaten) met centraal middenblad 16 plaatsen</p>	 <p>3200 3400</p> <p>MG1 EC 35 12 plaatsen</p>	 <p>3500 3400</p> <p>MG1 EC 08 12/14 plaatsen</p>	 <p>4700 3400</p> <p>MG1 EC 36 16 plaatsen</p>	 <p>5300 3400</p> <p>MG1 EC 09 16/20 plaatsen</p>	 <p>3400 3400</p> <p>MG1 EC 10 16 plaatsen</p>
 <p>5991 1800</p> <p>MG1 EC 15 (incl. 2 koppelplaten) 16/20 plaatsen</p>	 <p>3580 1800</p> <p>MG1 EC 16 (incl. 2 koppelplaten) 10/12 plaatsen</p>	 <p>4480 1800</p> <p>MG1 EC 17 (incl. 2 koppelplaten) 12/14 plaatsen</p>	 <p>5080 1800</p> <p>MG1 EC 39 (incl. 3 koppelplaten) 14/16 plaatsen</p>	 <p>5380 1800</p> <p>MG1 EC 18 (incl. 3 koppelplaten) 16/18 plaatsen</p>	 <p>6580 1800</p> <p>MG1 EC 40 (incl. 4 koppelplaten) 18/20 plaatsen</p>	 <p>7180 1800</p> <p>MG1 EC 19 (incl. 4 koppelplaten) 18/24 plaatsen</p>



TMeeting 3 420x120cm zwart frame met Oak medium 38mm blad.  
Getoonde stoelen: Milos meeting HV  
verrijdbaar met design armleggers.

TMeeting 3 vergadertafels zijn voorzien van een robuust T-poot onderstel voor optimale bewegingsvrijheid. Bladen uitgevoerd in 38mm krasvast melamine in 16 kleuren.

Het metalen onderstel met stevige koppelplaten onder de bladnaden is leverbaar in de kleuren wit, alu of zwart.

Optionele inbouwunits voor stroom en data op aanvraag mogelijk (zie pag. 156).

Model			
MG3028			8 personen
MG3036			10 personen
MG3042			12 personen
MG3056			16 personen



### Onderstel metaalkleuren

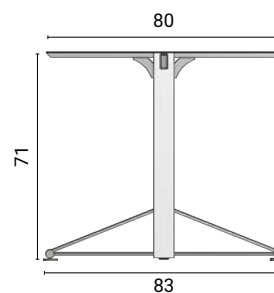

### Bladkleuren melamine 38mm

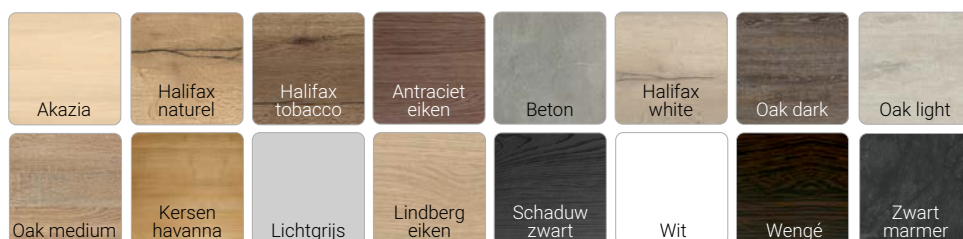



TMeeting 4 met zijn elegante schuin geplaatste poot is volledig naar wens op te bouwen.

Kies voor de lage variant en creëer uw gewenste vergader- of kantine tafel. De hoge stabiele variant maakt het mogelijk om functionele statafels te genereren.

TM4 poten zijn geproduceerd met een 5x5 cm buisframe en een stevige montage basisplaat wat de tafel optimale stevigheid geeft. Eindeloos te combineren dus altijd de tafel naar wens gemaakt.



## TMeeting 4 rond 120cm

### Bestaande uit:

4 x TM4 poot 110h zwart

1 x blad 120 rond Halifax naturel

Getoonde krukken: Clark



TMeeting 4 laag model



TMeeting 4 hoog model





VOORRAAD



LEVERTIJD



GARANTIE



MAATWERK



MONTAGE

## TMeeting 4 320x160

### Bestaande uit:

6 x TM4 poot 72h zwart  
2 x blad 160 x 160 cm Halifax  
natuur (nerf over breedte)  
2 x U-profiel 140cm

Getoonde stoelen: City Deco



VOORRAAD

### Model laag 74,5h

Rechthoek 180 x 90 cm

Rechthoek 200 x 100 cm

Rechthoek 240 x 120 cm

Rechthoek 320 x 160 cm

Vierkant 120 x 120 cm

Vierkant 160 x 160 cm

### bestaande uit

4 poten 72h, 1 u-profiel

4 poten 72h, 1 u-profiel

6 poten 72h, 1 u-profiel

6 poten 72h, 2 u-profielen

4 poten 72h

4 poten 72h



VOORRAAD

### Model hoog 112h

Rechthoek 180 x 90 cm

Rechthoek 200 x 100 cm

Vierkant 120 x 120 cm

Vierkant 160 x 160 cm

### bestaande uit

4 poten 110h, 1 u-profiel

4 poten 110h, 1 u-profiel

4 poten 110h

4 poten 110h



LEVERTIJD

### Model laag 74,5h

Rond 100cm

Rond 120cm

Rond 160cm

### bestaande uit

4 poten 72h

4 poten 72h

6 poten 72h



LEVERTIJD

### Model hoog 112h

Rond 100cm

Rond 120cm

Rond 160cm

### bestaande uit

4 poten 110h

4 poten 110h

6 poten 110h

(Óf kies het aantal poten obv het aantal zitplaatsen)

Bladen met afgeronde hoeken  
en afwijkende maatvoeringen  
op aanvraag

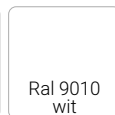
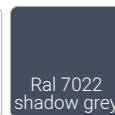

### Onderstel metaal kleuren

Ral 9005  
zwartRal 9006  
aluminiumRal 9010  
witRal 7022  
shadow grey

VOORRAAD

### Blad groep 1

#### Melamine op voorraad

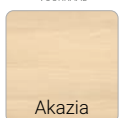

Akazia

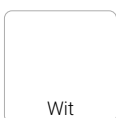

Wit

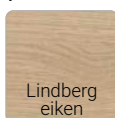
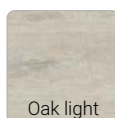
Lindberg  
eiken

Oak light

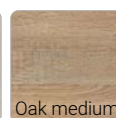

Oak medium

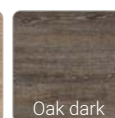

Oak dark

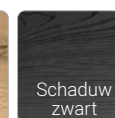
Halifax  
naturelSchaduw  
zwart

MAATWERK

### Maatwerk



LEVERTIJD

### Blad groep 2

#### Melamine op bestelling

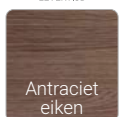
Antraciet  
eiken

Beton

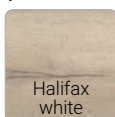
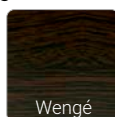
Halifax  
white

Wengé

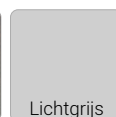

Lichtgrijs

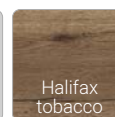
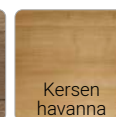
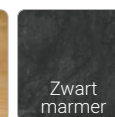
Halifax  
tobaccoKersen  
havannaZwart  
marmer

Ook maatwerk op  
aanvraag in elke gewenste  
maatvoering op bestelling  
leverbaar, rekening houdend  
met maximale plaatmaten  
(levertijd 4-6 weken).



## Mara 253 en 258

Vierkante kolomtafels met stabiele voetplaat en stevige bladdrager.  
Leverbaar in 3 modellen in de kleuren matwit, alu of matzwart.



### Kolomtafel vierkant



Mara 258 met blad 60 x 60cm 74h

Mara 258 met blad 60 x 80cm 74h

Mara 258 met blad 80 x 80cm 74h

Mara 258 met blad 60 x 60cm 112h

Mara 258 met blad 60 x 80cm 112h

Mara 258 met blad 80 x 80cm 112h

Mara 258 XL met blad 60 x 100cm 74h

Mara 258 XL met blad 60 x 120cm 74h

Mara 253 met blad 120 x 80cm 74h

Mara 253 met blad 140 x 80cm 74h



(Overige bladmaten op aanvraag)

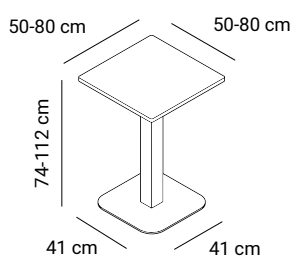

Mara 258

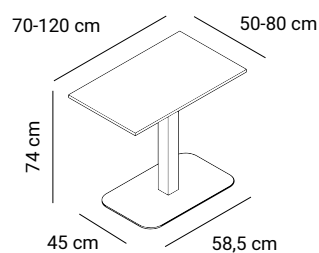

Mara 258 XL

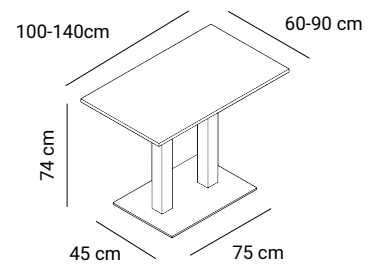

Mara 253



VOORRAAD



LEVERTIJD



GARANTIE



MAATWERK



MONTAGE

## Mara 230 en 250

Ronde kolomtafels voor bladen tot 150cm doorsnede. Zeer stabiele tafel met centrale kolompoot op een zeer stevige en zware voetplaat voor optimale beenruimte.

Frame uit voorraad leverbaar in 3 modellen in matwit, alu of matzwart. Op bestelling in 7 unieke RAL kleuren (muv model Mara 250 XL: vanaf 5 stuks).

# mara®



Mara 250 XL matzwart met blad 150cm



LEVERTIJD

### Kolomtafel rond

Mara 230 met blad 60cm rond 74h

Mara 230 met blad 70cm rond 74h

Mara 230 met blad 80cm rond 74h

Mara 230 met blad 90cm rond 74h

Mara 250 met blad 100cm rond 74h

Mara 250 met blad 110cm rond 74h

Mara 250 met blad 120cm rond 74h

Mara 250 XL met blad 130cm rond 74h

Mara 250 XL met blad 140cm rond 74h

Mara 250 XL met blad 150cm rond 74h

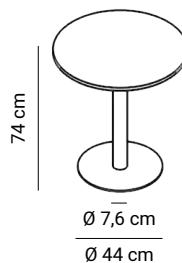

Mara 230

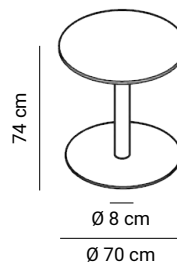

Mara 250

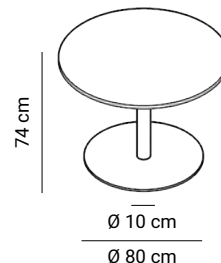

Mara 250 XL

(Overige bladmaten op aanvraag)



LEVERTIJD

### Metaalkleuren Mara onderstellen



VOORRAAD

### Metaalkleuren Mara onderstellen



VOORRAAD

### Blad groep 1 Melamine 25mm op voorraad

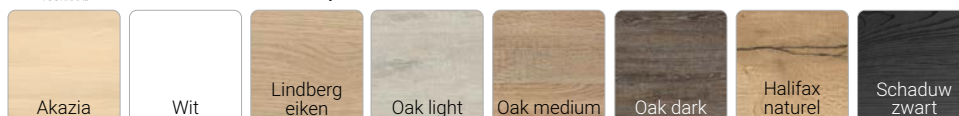

LEVERTIJD

### Blad groep 2 Melamine 25mm op bestelling

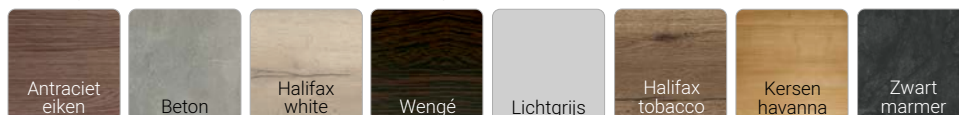

Standaard voorzien van stelvoetjes voor optimale stabiliteit.

















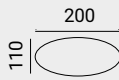

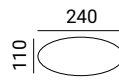

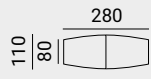
Q4 meeting kolomtafel wit met blad tonvormig  
280 x 110cm Canaletto walnut.  
Getoonde stoelen: City met pyramide onderstel wit.

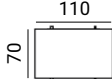

Q4 meeting tafels zijn passend in iedere ruimte en te combineren met een ruime keuze aan onderstellen, kleuren en bladmaten. Glazen bladen rond en ovaal bij trompetpoten op aanvraag leverbaar. Optionele inbouwunits voor stroom en data op aanvraag mogelijk (zie pag. 156).

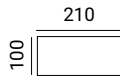

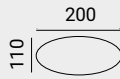
Model	Q4 meeting
 	Losse trompetpoot 73h in alu, wit of shadow grey Losse trompetpoot 73h in chroom
 	Tafel 100cm rond 76h met kolompoot A/I/R Tafel 100cm rond 76h met kolompoot C chroom
 	Tafel 120cm rond 76h met kolompoot A/I/R Tafel 120cm rond 76h met kolompoot C chroom
 	Tafel 200 x 110 ovaal 76h met 2x kolompoot A/I/R Tafel 200 x 110 ovaal 76h met 2x kolompoot C chroom
 	Tafel 240 x 110 ovaal 76h met 2x kolompoot A/I/R Tafel 240 x 110 ovaal 76h met 2x kolompoot C chroom
 	Tafel 280 x 110 tonvormig 73h met 2x kolompoot A/I/R Tafel 280 x 110 tonvormig 73h met 2x kolompoot C chr
 	Verlengstuk 70 x 110 voor tafel tonvormig (wordt 350 x 110) incl. 1x kolompoot

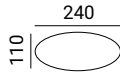
Model	X2 meeting (frame in white of silver)
 	Tafel 210 x 100 rechthoek 76h met frame in alu of wit
 	Tafel 200 x 110 ovaal 76h met frame in alu of wit
 	Tafel 240 x 110 ovaal 76h met frame in alu of wit



Onderstel metaalkleuren



Bladkleuren melamine 30mm





Follow Break monochromatic in kleur zand RAL 7044 met rond blad 110cm  
Getoonde stoelen:  
City Déco 4-poots



Gepatenteerd systeem



Follow meeting wit met blad rond 160cm



Follow meeting Cone zwart met blad rond 140cm

## Follow Break en Follow Meeting

Eenvoudig en stroomloos vergaderen aan een ronde zit-statafel, dat kan met de Follow Break en Meeting tafels. Model Break met zware voetplaat en kolompoot rond of vierkant voor bladen tot max 110cm.

De Follow Meeting is de grotere broer met fraaie optionele Cone kolompoot, en bladmaat tot rond 160cm.

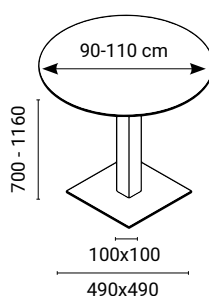

Follow Break vierkant

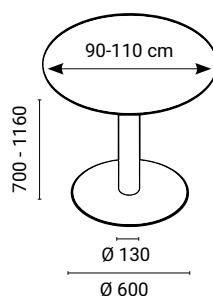

Follow Break rond

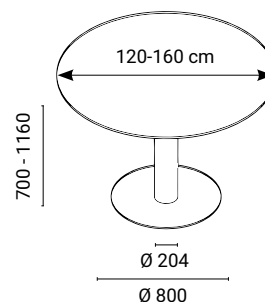

Follow Meeting

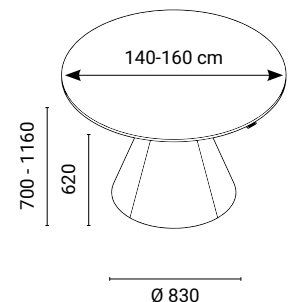

Follow Meeting Cone

## Follow Tilting

Multifunctionele tafel; hoogte verstelbaar, verrijdbaar en opklapbaar. De ideale Follow Tilting met gepatenteerde Mara techniek geeft u maximale vrijheid in elke ruimte.

### Model

Follow tilting 140 x 80 cm

Follow tilting 160 x 80 cm

Follow tilting 180 x 80 cm

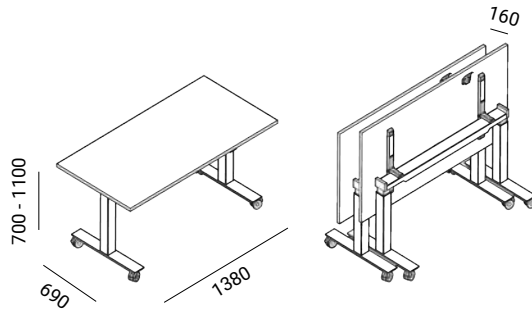

### Metaalkleuren



Bladkleuren: zie pag. 131





## Flex 3+ meeting 3-poots 240x120

### Bestaande uit:

Flex 3+ meeting 240 (bestaand uit Flex 3+ 120 en Flex 3+ aanbouw)

Blad maatwerk 240 x 120cm in Halifax White  
Getoonde stoelen: City spinpoot wit  
verrijdbaar

## Flex 3+ meeting 4-poots 320x160

### Bestaande uit:

Flex 3+ bench 180  
Flex synchroon koppelkabel  
2 x blad 160 x 160cm Halifax naturel  
4 x Flex 3+ aanbouwsteun  
TM1 koppelplaat  
2 x U-profiel 140cm  
Getoonde stoelen: Join slede



## Flex 3+ meeting 2-poots wang 240x120

### Bestaande uit:

Flex 3+ 180 wang 80 zwart  
2x blad 120 x 120cm Halifax naturel  
(nerf over breedte)  
2x Flex 3+ aanbouwsteun  
2x U-profiel 140cm  
Getoonde stoelen: Join meeting 4-poots



### Gewicht capaciteit

100 kg (2-poots wang)  
150 kg (3-poots en 4-poots bench)



### Stroom verbruik

In gebruik 118 W  
Standby < 0,3 W



### Snelheid

40 mm/s tot 150 kg



### Verstelbereik

64 - 130 cm



### Geluidsniveau

< 38 dB(A)





VOORRAAD



LEVERTIJD



GARANTIE



CONFIGUREERBAAR



MONTAGE



Flex 3+ meeting 3-poots



Flex 3+ meeting 4-poots

Zit-sta vergaderen is nu eenvoudig te realiseren met de Flex 3+ meeting. De Flex 3+ met 3 T-poten, 2 stevige wangenvoten of als 4-poots bench met een hoogte bereik van 64-130cm geeft optimale bewegingsruimte waardoor u vrij bent om stoelen te plaatsen waar u wilt.

Het dynamisch gewicht van de Flex 3+ meeting is 100kg (2 poten) of 150kg (3/4 poten) inclusief blad. Standaard voorzien van gebruiksvriendelijke memory-unit met hoogte aanduiding.

Inbouwunits voor stroom en data zie pag. 156

**Model**

Flex 3+ meeting 2-poots wang 80 200 x 100 cm\*

Flex 3+ meeting 2-poots wang 80 240 x 100 cm

Flex 3+ meeting 2-poots wang 80 240 x 120 cm\*

Flex 3+ meeting 3-poots 240 x 100 cm

Flex 3+ meeting 3-poots 240 x 120 cm

Flex 3+ meeting 3-poots 280 x 120 cm

Flex 3+ meeting 3-poots 320 x 120 cm

Flex 3+ meeting 4-poots 280 x 160 cm

Flex 3+ meeting 4-poots 320 x 160 cm\*

\* Uit voorraad leverbaar

(Overige bladmaten en bladen met afgeronde hoeken op aanvraag)

**VOORRAAD** **Onderstel metaal kleuren**

Ral 9005 zwart	Ral 9006 aluminium	Ral 9010 wit	Ral 7022 shadow grey
----------------	--------------------	--------------	----------------------



Flex 3+ memory unit (standaard)

**VOORRAAD** **Blad groep 1 Melamine 25mm op voorraad**

Akazia	Wit	Lindberg eiken	Oak light	Oak medium	Oak dark	Halifax naturel	Schaduw zwart
--------	-----	----------------	-----------	------------	----------	-----------------	---------------

**4-6 weken LEVERTIJD** **Blad groep 2 Melamine 25mm op bestelling**

Antraciet eiken	Beton	Halifax white	Wengé	Lichtgrijs	Halifax tobacco	Kersen havanna	Zwart marmer
-----------------	-------	---------------	-------	------------	-----------------	----------------	--------------

**Maatwerk**

Ook maatwerk op aanvraag in elke gewenste maatvoering op bestelling leverbaar, rekening houdend met maximale plaatmaten (levertijd 4-6 weken).



## Freestand 240x120

### Bestaande uit:

Onderstel Freestand meeting 4-poots 240 x 120cm in wit ral 9010

Blad maatwerk 240 x 120cm in Halifax white

Memory unit met hoogte aanduiding

Getoonde stoelen: City ringpoot shadow grey



## Freestand 160x160

### Bestaande uit:

Onderstel Freestand meeting 4-poots

160 x 160cm in wit ral 9010

Blad 160 x 160cm in Halifax naturel



### Tafel afmeting

Diepte: 80-200cm  
Lengte: 80-960cm



### Kolom afmeting

2-segment: 70/65mm



### Gewicht capaciteit

Vanaf 100kg bij 4-poots



### Aantal poten

4-12 kolommen



### Stroom verbruik

In gebruik 118 W  
Standby < 0,3 W



### Verstelbereik

2-segment: 72-122cm



### Snelheid

38 mm/s



### Geluidsniveau

< 38 DB

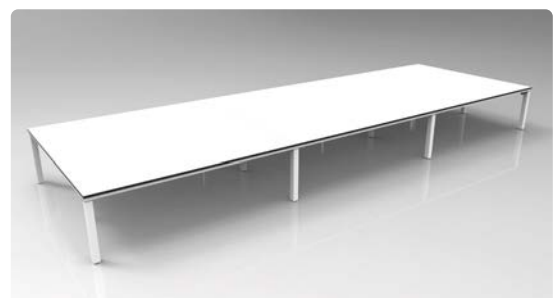

Freestand meeting 720 x 160cm (op aanvraag)

Freestand meeting bestaat uit een dragend kaderframe met een hoogte van 30mm en zeer stabiele kolompoten op de hoek en als tussenpoot. De kolompoten zijn leverbaar in een 2-segment kolom met hoogte 72-122cm. De modulaire kaders zijn mogelijk vanaf 80cm tot max 240cm (per 10cm). Met de vrijheid om zelf uw ideale formaat te kiezen creëert u altijd uw perfecte zit-sta vergadertafel.



**Model**

- Freestand meeting 4-poots 200 x 100cm
- Freestand meeting 4-poots 240 x 120cm
- Freestand meeting 6-poots 480 x 120cm
- Freestand meeting 4-poots 160 x 160cm
- Freestand meeting 6-poots 320 x 160cm
- Freestand meeting 6-poots 480 x 160cm



(Overige bladmaten op aanvraag)

**Opties**

- Memory unit met 4 geheugens en display
- Kabelbak klapbaar tbv 160cm
- Kabelbak klapbaar tbv 200cm
- Kabelbak klapbaar tbv 240cm
- Kabelgeleider magnetisch

(Inbouwunits voor stroom en data zie pag. 156)



Kabelgeleider magnetisch

Onderstel metaal kleuren

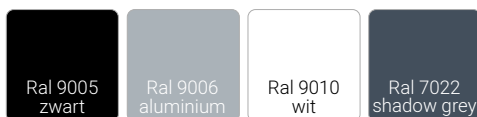

Slank randdragend frame met optimale ruimte voor inbouwmodules



Blad groep 1  
Melamine 25mm op voorraad

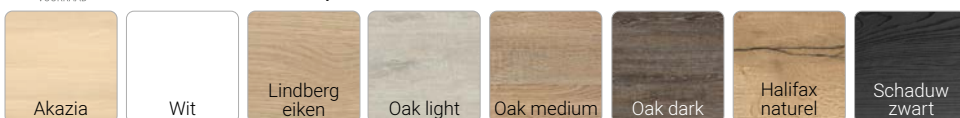

Blad groep 2  
Melamine 25mm op bestelling

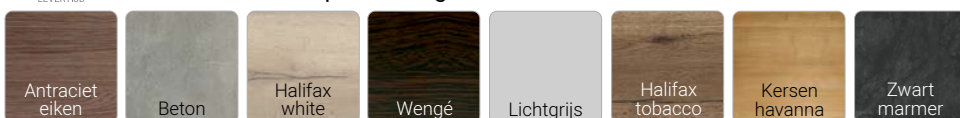

Maatwerk

Ook maatwerk op aanvraag in elke gewenste maatvoering op bestelling leverbaar, rekening houdend met maximale plaatmaten (levertijd 4-6 weken).



### Bi-Box

De Bi-Box is een elektrificatie inbouwmodule voorzien van een sluitklep die aan twee zijden open/dicht kan en aan beide zijden is voorzien van een borstelafsluiting. De Bi-Box is ideaal voor vergader- en conferentietafels.



Kleur: zwart, wit, zilver of koper

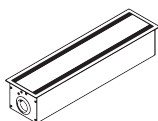
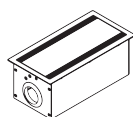

De Bi-Box inbouwmodule is leverbaar in 2 afmetingen:

#### Bi-Box small :

inbouwmaat 286x135mm  
buitenmaat 300x150mm

#### Bi-Box large :

inbouwmaat 592x135mm  
buitenmaat 605x150mm

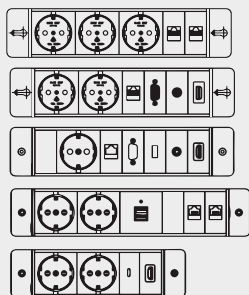
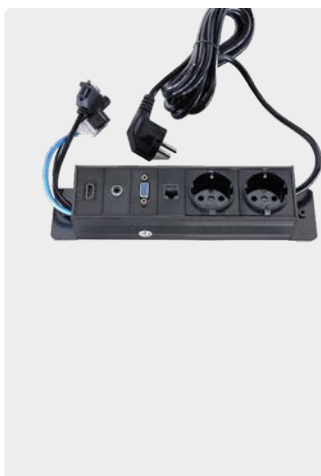

#### Voor de Bi-Box small:

- 3x stroom
- 2x stroom + 1x USB A+C charger + 1x CAT6 + 1x HDMI
- 3x stroom + 2x data CAT6
- 2x stroom + 1x data CAT6 + 1x VGA + 1x audio + 1x HDMI
- 1x stroom + 1x data CAT6 + 1x VGA + 1x audio + 1x HDMI + 1x USB
- 2x stroom + 2x data CAT6 + 2x USB
- 2x stroom + 1x HDMI + 1x USB C

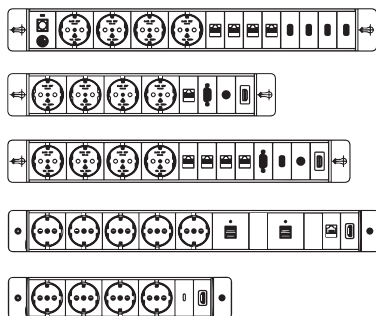

#### Voor de Bi-Box large:

- 4x stroom + 4x data CAT6 + 4x USB
- 4x stroom + 1x data CAT6 + 1x VGA + 1x audio + 1x HDMI
- 4x stroom + 4x data CAT6 + 1x VGA + 1x audio + 1x HDMI + 1x USB
- 5x stroom + 1x data CAT6 + 4x USB + 1x HDMI
- 4x stroom + 1x HDMI + 1x USB C
- 6x stroom

Andere configuraties op aanvraag mogelijk.



VOORRAAD



LEVERTIJD



GARANTIE



MONTAGE

## Losse componenten en inbouwmodules

### Stekkerdozen en stroomsnoeren

Gecertificeerde stroomvoorziening met GST18 koppeling.

(ook in BE/FR versie leverbaar)



Stekkerdoos 3x stroom  
Stekkerdoos 4x stroom  
Stekkerdoos 5x stroom  
Stekkerdoos 6x stroom

Aansluitsnoer\*

2 meter

3 meter

Koppelsnoer\*

2 meter

3 meter

\*Andere lengtes op aanvraag.

### De Qi Power Pop-Up Meeting

werkt met een 'pop-up'-mechaniek en geeft u door een zachte druk op de bovenkant toegang vanaf elke positie tot uw gewenste stroomvoorziening.

De Qi Power Pop-Up Meeting kan tevens snel en eenvoudig gemonteerd worden in een rond gat van 120 mm in het werkblad.

Leverbaar in de kleuren: zwart en wit.



De Qi Power Pop-Up Meeting heeft maar liefst 4 keer 230V stopcontacten, 2 keer USB A en 2 keer USB-C, 15 W aansluitingen en een ingebouwde Qi-draadloze lader, incl. vast aansluitsnoer 2 mtr.

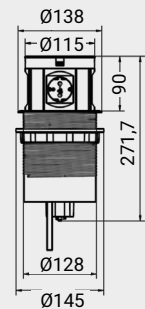

### Power Desk IN

Mooie inbouw oplossing die d.m.v. een push-to-open kan worden geopend (inbouwdikte tot 50mm). Verkrijgbaar in de kleur zwart of wit. Met 1 meter vaste kabel met een eGST plug.



2x Stroom + USB A+C Charger  
2x Stroom + USB-A+C Charger + 1x Leeg  
3x Stroom  
3x Stroom + 1x Keystone  
3x Stroom + USB A+C Charger

### Power Desk Insert

is een inbouwunit met een directe toegang. De ranke en moderne uitstraling valt mooi weg in het bureau. Met 0,5 meter vaste kabel met een eGST plug.

- zwart met aluminium zijkappen  
- wit met aluminium zijkappen



2x stroom  
1x USB-A en 1x USB-C charger,  
1x lege moduleplaats  
(plaats voor 2 keystone\*)

\*De lege moduleplaats is in te vullen met CAT6A, USB 3.0, USB-C data, HDMI of kabeltunnel (op aanvraag)  
Inbouwmaat : 234 x 52mm

### Desk in Slide

inbouwmodule voor vergadertafel voorzien van een schuifdeksel. Standaard voorzien van 2x stroom, 2x USB charger, 1x CAT6 en 1x HDMI aansluiting. Inclusief 1 meter vaste kabel met eGST plug. Schuifdeksel 2-delig in geborsteld aluminium kleur zilver of zwart



2x stroom, 1x USB-A en 1x USB-C charger, 1x Cat6 data en 1x HDMI aansluiting

Inbouwmaat 268x69mm







Voor elke ruimte en gebruiker bieden wij u een passende opberg-oplossing.

Belangrijk is dat u hierin de juiste keuze maakt, want kasten zijn er in vele uitvoeringen en functies.

#### **Schuifdeurkasten:**

- efficiënt
- esthetisch zeer fraai
- akoestisch
- breed inzetbaar
- modulair in vele hoogten en breedtes

#### **Roldeurkasten:**

- ruimte besparend
- zeer functioneel
- gebruiksvriendelijk en praktisch
- leverbaar in diverse modellen

#### **Draaideurkasten:**

- in hout of metaal
- zéér breed inzetbaar
- leverbaar in diverse modellen, maten en kleuren

#### **Boekenkasten:**

- vrijstaand of als wandkast
- modulair in diverse uitvoeringen
- eenvoudig te transformeren

#### **Lockerkasten:**

- veilig en efficiënt
- diverse slotsystemen
- gebruiksvriendelijk
- vele maten en uitvoeringen



Slide & Go met 4 akoestische deuren (2x model 2016)  
321 x 195h, met luxe melamine ombouw en 16x legbord SG 80

Over akoestiek op de werkplek.

Diverse onderzoeken hebben aangetoond dat overlast van geluid een groot effect heeft op onze productiviteit en zelfs kan leiden tot stress en ziekte.

De moderne kantoortuinen met vaak een open structuur en de hedendaagse arbeidsomstandigheden in onze dynamische wereld vragen ons om passende akoestische oplossingen.



De akoestische ECO-  
screen deuren dempen  
de omgevingsgeluiden

De Slide & Go kasten zijn voorzien van geluidsabsorberende PET-vilt panelen in de schuifdeuren. Plaatst u de kasten vrij in de ruimte? Maak dan gebruik van onze speciale akoestische achterpanelen.

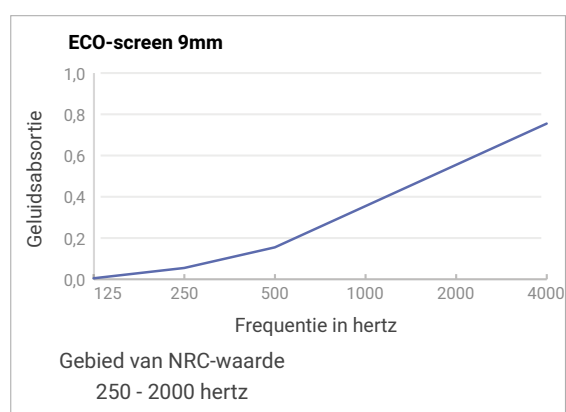

Kleuren ECO-screen

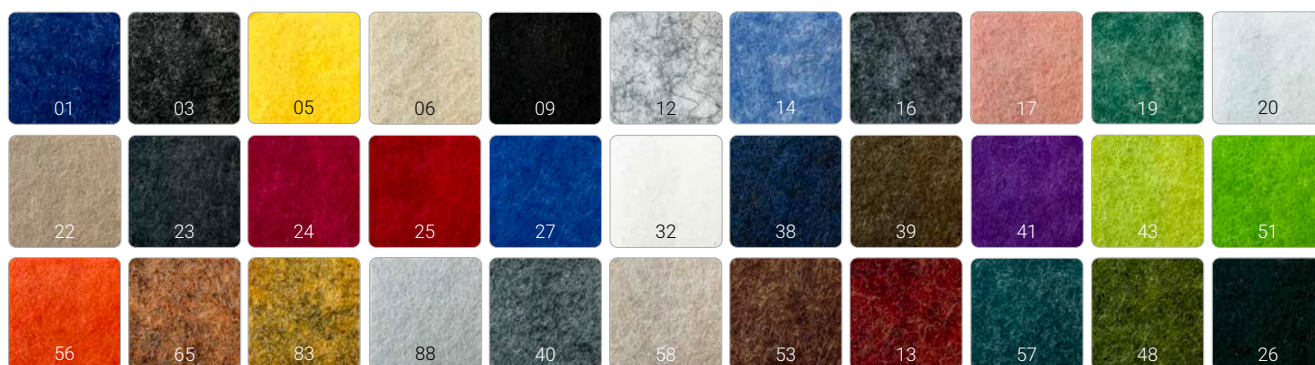





"Ssssst, mag het wat stiller?"



Slide & Go 1216 zwart voorzien van akoestische achterwand in ECO-screen kleur 51 met V-groef en magnetische open plantenbakken van 80cm.



Degelijk slot aan de zijkant van de schuifdeur geeft een strakke uitstraling (standaard op elke S&G kast)



Slide & Go 1216 zwart met stalen top en 4 legborden 80 zwart voor 3 ordners hoogte



Slide & Go model 9020 shadow grey met ECO-screen 09 zwarte deurpanelen, luxe kastbouw in schaduw zwart en 2x legbord SG 100



1 Basis kastbouw



2 Luxe kastbouw

Geef uw Slide & Go een andere uitstraling met de melamine ombouwset.

De aangepaste top en zijkantafwerking zijn optioneel per kastmodel te bestellen (levertijd 4-6 weken).

Kies voor de:

- 1 Basis kastbouw diepte 44,2 cm loopt gelijk met de binnendeur (buitendeur steekt uit).
- 2 Luxe kastbouw diepte 50 cm loopt gelijk met de buitendeur. Hierbij worden de deuren in een fraaie en passende nis omsloten.



Top en kastbouw op bestelling  
Scan de prijslijst voor alle mogelijkheden

#### Kastbouw en plantenbak melamine kleuren

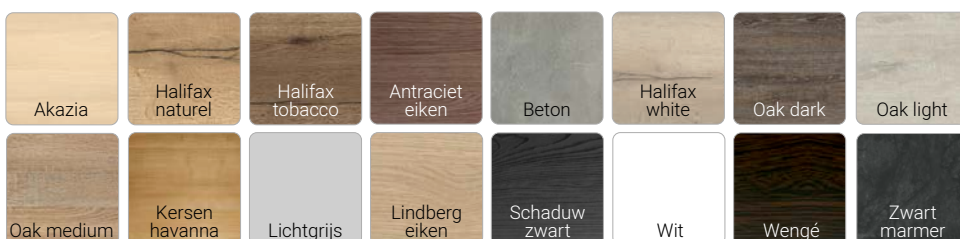



VOORRAAD



LEVERTIJD



GARANTIE



DUURZAAM



CIRCULAIR



AKOESTIEK



CONFIGUREERBAAR



MONTAGE

Model	Afmeting hxb (cm)
9016 (2-delig)	83 x 160
9020 (2-delig)	83 x 200
1216 (2-delig)	123 x 160
1220 (2-delig)	123 x 200
2016 (2-delig)	192 x 160
2020 (2-delig)	192 x 200

Bovenstaande modellen uit voorraad leverbaar met stalen top.  
Op bestelling leverbaar met melamine top of kastombouw.



Metaal kleuren

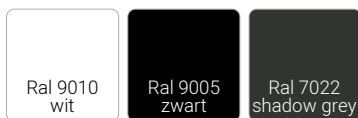

S&G model 9020 wit 9010 met melamine plantenbak 200x44x22,5h in Halifax naturel voorzien van rubbercoating binnenzijde.

**Kasten uit voorraad leverbaar in wit ral 9010, zwart ral 9005 en shadow grey ral 7022.**

**Eco-screen viltpanelen uit voorraad leverbaar in wit, zwart en antraciet. Andere kleuren op bestelling (3-4 weken levertijd). Zie pagina 160 voor de kleuren.**

09 20 03

**Opties Slide & Go schuifdeurkast**

S&G legbord 80 (74x35cm) of 100 (94x35cm) in wit 9010, zwart 9005 of shadow grey 7022

S&G uittrekbaar Hettich hangmappenframe zwart, 80 (74x35cm) / 100 (94x35cm)

S&G set dieptestangetjes tbv folio en 2x A4 dwars in hangmappenframe

S&G uittrekbeveiliging tbv 2x hangmappenframe / 3x hangmappenframe

S&G softclose tbv 2-deurs

S&G melamine draagsteunen 160 en 200

S&G extra sleutel (ter uitbreiding of bij verlies)\*

S&G magnetische open plantenbak 80x44,2x22h wit 9010, zwart 9005 of shadow grey 7022

S&G magnetische open plantenbak 100x44,2x22h wit 9010, zwart 9005 of shadow grey 7022

S&G magnetische achterwand in geluidsabsorberend ECO-screen 9mm\*

S&G melamine plantenbak 160x44,2x22,5h (incl. rubbercoating en melamine draagsteunen 160)\*

S&G melamine plantenbak 200x44,2x22,5h (incl. rubbercoating en melamine draagsteunen 200)\*

\* Op bestelling leverbaar



S&G uittrekbaar hangmappenframe

Maak uw S&G kast uniek met keuze uit wel 33 kleuren akoestische ECO-screen deurpanelen!

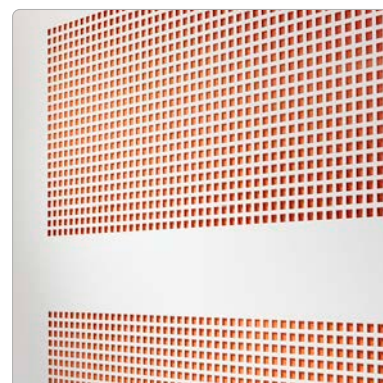

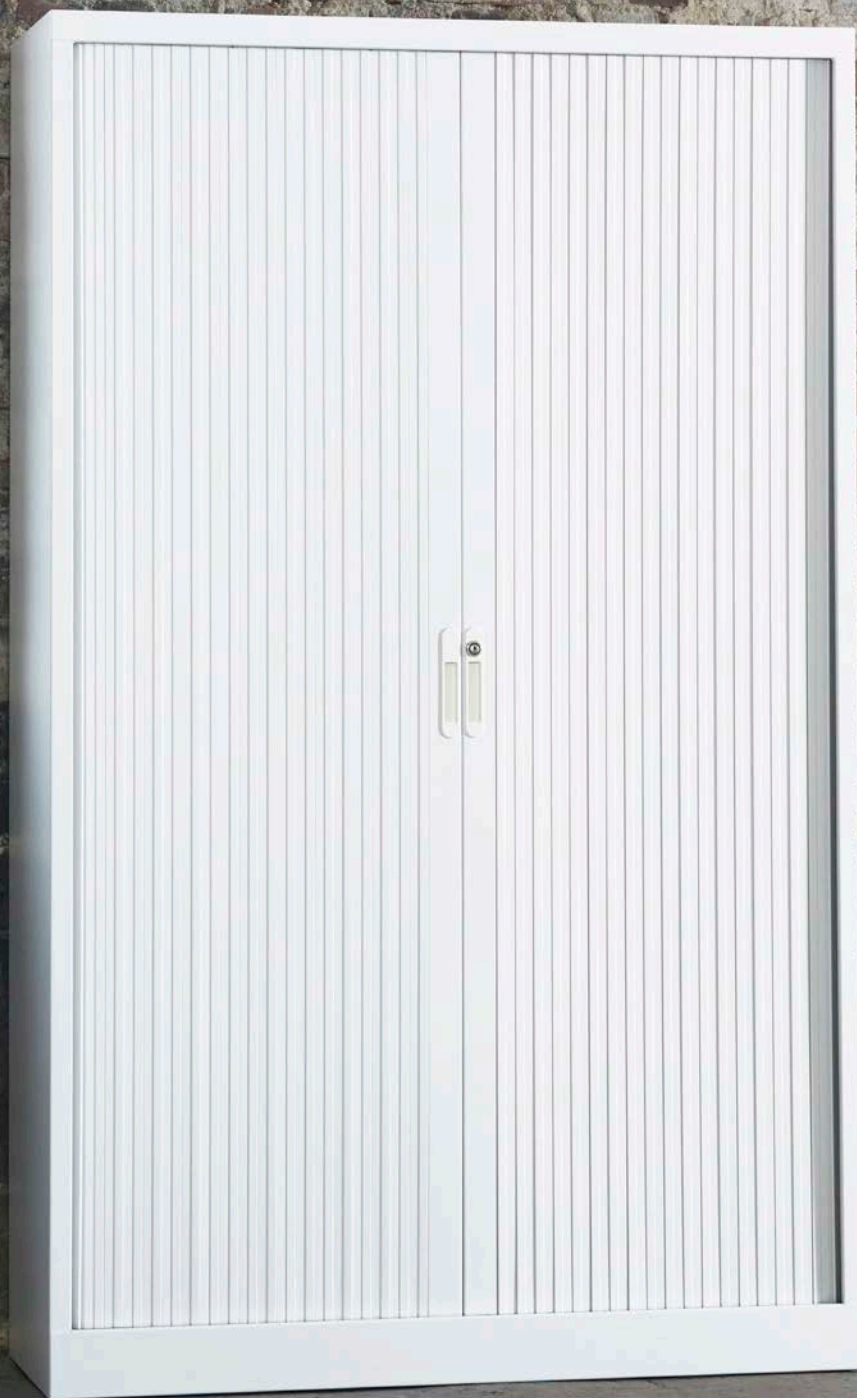

Slot voorzien van  
2 kniksleutels



Sluitlamellen,  
voorzien van  
magneetstrips op  
alle Ecotec kasten.

Kwaliteits-roldeurkast met verticaal  
geplaatste kunststofdeuren.

EC 2000

Ral 9003 wit

Roldeurkast standaard geleverd met zwarte legborden! De kasten zijn voorzien van 4 van binnenuit verstelbare stelvoetjes. Afsluitbare deuren van brandvertragende kunststof.

Per legbord kunt u 13 standaard ordners opbergen (max 35 kg). Legborden standaard geschikt voor laterale hangmappen A4, met een spoorbreedte van 33,5 cm. Tevens mogelijkheid voor laterale hangmappen in het plafond.



EC 74 - 800  
(2 OH)



EC 74 - 1200  
(2 OH)



EC 1050  
(2 OH)



EC 1450\*  
(3 OH)



EC 2000  
(5 OH)



EC 2000  
Ral 7016 antraciet



EC 2000  
Ral 9006 aluminium



EC 1050  
Ral 9006 aluminium

Model		hxbxd (cm)
EC 2000	incl. 4 legborden AL 452 zwart	198 x 120 x 45
EC 1450*	incl. 3 legborden AL 452 zwart	145 x 120 x 45
EC 1050	incl. 1 legbord AL 452 zwart	105 x 120 x 45
EC 74-1200	incl. 1 legbord AL 1200 zwart	74 x 120 x 45
EC 74-800	incl. 1 legbord AL 800 zwart	74 x 80 x 45

\* Op bestelling

**Opties**  
BODLEGB 104,2 x 35,4cm  
(BL bodemlegbord tbv Ecotec 120cm breed, leverbaar in alle kastkleuren)



VOORRAAD

**Topbladen bxd (cm)  
Bladgroep 1**

80 x 46  
120 x 46



LEVERTIJD

**Topbladen bxd (cm)  
Bladgroep 2**

80 x 46  
120 x 46

Topbladen kleuren zie pag. 168



VOORRAAD

Kastombouw  
kleuren



Roldeurlamel  
kleuren





De NG roldeurkast optimaliseert uw opbergmogelijkheden.

Voorzien van een vlakke bodemplaat (tbv gebruik van ordners) en een zeer lage stabiele sokkel met 4 stelvoetjes.

De deuren sluiten netjes door de magneetstrips in de sluitlamel. De verticale gladde lamellen zijn brandvertragend en leverbaar in vele kleurcombinaties.

## NG 2000

Ral 9003 wit



**GAPSA**<sup>®</sup>  
Espacio útil

## NG 1200

Ral 9005 zwart



NG 74-800  
(2 OH)



NG 74-1200  
(2 OH)



NG 1050  
(2 OH)



NG 1200  
(3 OH)



NG 1450  
(3 OH)



NG 1600  
(4 OH)



NG 2000  
(5 OH)



VOORRAAD



LEVERTIJD



CIRCULAIR



GARANTIE



Legbord in de Ral-kleuren van de kastombouw leverbaar



Laterale hangmappen in plafond



Volledig vlakke bodem



Stelpootjes van binnenuit verstelbaar



Grepen in kleur kastombouw en slot met 2 kniksleutels



Omschrijving	Buitenmaat hxbxd (cm)	Binnenmaat hxbxd (cm)
NG 2000	198 x 120 x 45	188 x 104,2 x 41
NG 2010	198 x 102 x 45	188 x 86,2 x 41
NG 1200	120 x 120 x 45	110 x 104,2 x 41
NG 1050	105 x 120 x 45	95 x 104,2 x 41
NG 74-1200	73,5 x 120 x 45	70 x 104,2 x 41
NG 74-800	73,5 x 80 x 45	70 x 63,2 x 41



VOORRAAD

Omschrijving	Buitenmaat hxbxd (cm)	Binnenmaat hxbxd (cm)
NG 2008	198 x 80 x 45	188 x 63,2 x 41
NG 2006	198 x 60 x 45	188 x 49 x 41
NG 1600	160 x 120 x 45	150 x 104,2 x 41
NG 1610	160 x 102 x 45	150 x 86,2 x 41
NG 1608	160 x 80 x 45	150 x 63,2 x 41
NG 1450	145 x 120 x 45	135 x 104,2 x 41
NG 1451	145 x 102 x 45	135 x 86,2 x 41
NG 1458	145 x 80 x 45	135 x 63,2 x 41
NG 1210	120 x 102 x 45	110 x 86,2 x 41
NG 1208	120 x 80 x 45	110 x 63,2 x 41
NG 1051	105 x 102 x 45	95 x 86,2 x 41
NG 1058	105 x 80 x 45	95 x 63,2 x 41



LEVERTIJD

Legborden	bxh (cm)	
AL 452	104,2 x 35,4	legbord tbv 120cm brede kast
VL 452	104,2 x 35,4	versterkt legbord tbv 120cm brede kast
AL 74-1200	104,2 x 35,4	dun versterkt legbord tbv 74-1200
AL 74-800	63,2 x 35,4	dun legbord tbv 74-800
AL 800	63,2 x 35,4	legbord tbv 80cm brede kast
AL 600	49 x 35,4	legbord tbv 60cm brede kast
AL 450	86,2 x 35,4	legbord tbv 102cm brede kast

Topbladen en accessoires: zie pag. 168-169

Kastombouw kleuren



Roldeurlamel kleuren



Sluitlamellen, voorzien van magneetstrips op alle NG kasten.



Geef uw roldeurkasten een andere uitstraling met een melamine kastombouwset. De set bestaat uit een aangepaste top met zijpanelen en is geschikt voor diverse kastcombinaties (levertijd 4-6 weken).



Ombouwset 3-delig	Topblad bxd (cm)	Zijpanelen hxd (cm)	4-6 weken LEVERTIJD
1x kast 74-800	85,2 x 46	73,5 x 46	
2x kast 74-800	165,2 x 46	73,5 x 46	
3x kast 74-800	245,3 x 46	73,5 x 46	
1x kast 74-1200	125,2 x 46	73,5 x 46	
2x kast 74-1200	245,2 x 46	73,5 x 46	
1x kast 1050	125,2 x 46	104,5 x 46	
2x kast 1050	245,2 x 46	104,5 x 46	

Ombouwset 3-delig	Topblad bxd (cm)	Zijpanelen hxd (cm)	4-6 weken LEVERTIJD
1x kast 1200	125,2 x 46	119,5 x 46	
2x kast 1200	245,2 x 46	119,5 x 46	
1x kast 1450	125,2 x 46	144,5 x 46	
2x kast 1450	245,2 x 46	144,5 x 46	
1x kast 1600	125,2 x 46	159,5 x 46	
2x kast 1600	245,2 x 46	159,5 x 46	
1x kast 2000	125,2 x 46	197,5 x 46	
2x kast 2000	245,2 x 46	197,5 x 46	

## Topbladen bxd (cm)



**Bladgroep 1**  
80 x 46  
120 x 46

## Blad groep 1 Melamine op voorraad

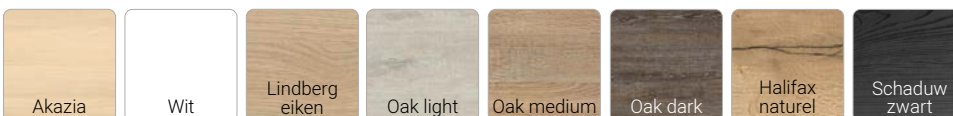

## Topbladen bxd (cm)



**Bladgroep 2**  
80 x 46  
120 x 46

## Blad groep 2 Melamine op bestelling

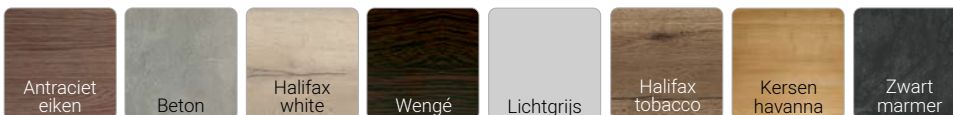

## Melamine plantenbak

hxbxd (cm)



RDK melamine plantenbak 80	80 x 45 x 22,5h
RDK melamine plantenbak 102	102 x 45 x 22,5h
RDK melamine plantenbak 120	120 x 45 x 22,5h

(incl. waterdichte rubbercoating)



SCAN  
VOOR  
PRIJSLIJST





VOORRAAD



LEVERTIJD



GARANTIE



MONTAGE

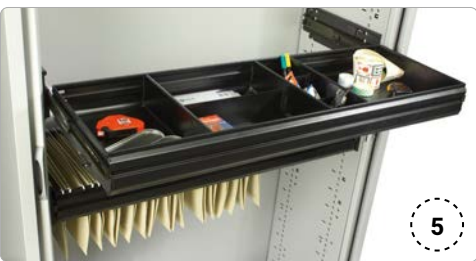

## 1

AL 452 legbord (voor 120cm brede kasten)\*

AL 450 legbord (voor 102cm brede kasten)\*

AL 800 legbord (voor 80cm brede kasten)\*

AL 600 legbord (voor 60cm brede kasten)\*

\*geschikt voor laterale hangmappen

VL 452 versterkt legbord (voor 120cm brede kasten)

niet geschikt voor laterale hangmappen

AL 74-1200 dun legbord (voor 120cm bureauhoge kasten)

AL 74-800 dun legbord (voor 80cm brede kasten)

AL legbord : max 35kg / VL legbord: max. 50kg.

Leverbaar in alle kastkleuren

## 2

SE boekensteun (tbv AL en VL legborden) in zwart 9005

## 3

BSL 1020 uittrekbaar hangmappenframe (voor 102cm brede kasten)

BE 1020 parallelgeleiding (tbv BSL 1020)

BSL 800 uittrekbaar hangmappenframe (voor 80cm brede kasten)

AT4 uittrekbeveiliging (voor 4x BSL frame)

AT3 uittrekbeveiliging (voor 3x BSL frame)

AT2 uittrekbeveiliging (voor 2x BSL frame)

**3** BSL 1200 uittrekbaar hangmappenframe (voor 120cm brede kasten)

(geschikt voor 3x A4 naast elkaar of 2x Folio naast elkaar

A4 hangmappen in de diepte) Leverbaar in zwart 9005

**4** BE 1200 parallelgeleiding voor BSL 1200

(geeft extra stabiliteit bij uittrekken van het hangmappenframe)

## 5

Kit 02-1200 (lade tbv BSL 1200)

Kit 02-800 (lade tbv BSL 800)

bodemplaat, 3 diepteschetjes, 2 dwarsschetjes 11cm,

1 dwarsschetje 31cm. Leverbaar in zwart 9005

### Extra sleutel

(ter uitbreiding of bij verlies)

### 6 Magnetische ECO-screen 9 achterwand

### Paneel afmeting hxb (cm)

NG 1200

119 x 120

EC/NG 1450

144 x 120

NG 1600

159 x 120

EC/NG 2000

198 x 120

(kleuren vilt ECO-screen 9 zie pag. 160)



Met de NG draaideur (NG-DD) en open kasten (NG-OK) wordt het kastenprogramma nog breder inzetbaar. Standaard voorzien van een vlakke bodemplaat, een lage stabiele sokkel met 4 van binnenuit verstelbare stelvoetjes. De draaideurkast heeft standaard metalen deuren met slot. Beide modellen zijn op bestelling leverbaar in diverse ralkleuren. (3-4 wk)



Model open kast	hxbxd (cm)	Model draaideurkast	hxbxd (cm)
NG-OK 2000 incl. 4 legborden	198 x 120 x 45	NG-DD 2010 incl. 4 legborden	198 x 102 x 45
NG-OK 2010 incl. 4 legborden	198 x 102 x 45	NG-DD 2008 incl. 4 legborden	198 x 80 x 45
NG-OK 2008 incl. 4 legborden	198 x 80 x 45	NG-DD 1451 incl. 3 legborden	145 x 102 x 45
NG-OK 1800 incl. 4 legborden	180 x 120 x 45	NG-DD 1458 incl. 3 legborden	145 x 80 x 45
NG-OK 1810 incl. 4 legborden	180 x 102 x 45	NG-DD 1051 incl. 2 legborden	105 x 102 x 45
NG-OK 1808 incl. 4 legborden	180 x 80 x 45	NG-DD 1058 incl. 2 legborden	105 x 80 x 45
NG-OK 1600 incl. 3 legborden	160 x 120 x 45	NG-DD 70-1020 incl. 1 legbord	70 x 102 x 45
NG-OK 1610 incl. 3 legborden	160 x 102 x 45	NG-DD 70-800 incl. 1 legbord	70 x 80 x 45
NG-OK 1608 incl. 3 legborden	160 x 80 x 45		
NG-OK 1450 incl. 3 legborden	145 x 120 x 45		
NG-OK 1451 incl. 3 legborden	145 x 102 x 45		
NG-OK 1458 incl. 3 legborden	145 x 80 x 45		
NG-OK 1050 incl. 2 legborden	105 x 120 x 45		
NG-OK 1051 incl. 2 legborden	105 x 102 x 45		
NG-OK 1058 incl. 2 legborden	105 x 80 x 45		
NG-OK 70-1200 incl. 1 legbord	70 x 120 x 45		
NG-OK 70-1020 incl. 1 legbord	70 x 102 x 45		
NG-OK 70-800 incl. 1 legbord	70 x 80 x 45		



Degelijk slot met 2 punt sluiting. (op model NG-DD)

#### Topbladen bxd (cm)

80 x 46

102 x 46

120 x 46

#### Kast en deur kleuren





Berg uw spullen veilig op achter slot en grendel met de metalen lockers van Gapsa. De gelaste kasten zijn leverbaar in diverse afmetingen en kleuren. De geventileerde deuren zijn voorzien van naamkaders en slot met 2 sleutels. Optioneel kan er gekozen worden voor diverse slotsystemen en kunnen de deuren, naast de basiskleuren, ook in blauw (RAL 5009) worden uitgevoerd.



T30X 1M1P met gelaste pootjes en standaard slot



T40X 1M5P met gelaste pootjes en standaard sloten



T40X 1M2P met gelaste pootjes en standaard sloten



Lockerkast T30X 40M1P  
met kastbank voor 4 deuren

#### Lockerkast opties (in 4 corpus metaalkleuren)

Schuin dak voor T30X 1 deur breed  
Schuin dak voor T30X 2 deuren breed  
Schuin dak voor T30X 3 deuren breed  
Schuin dak voor T30X 4 deuren breed



Schuin dak voor T40X 1 deur breed  
Schuin dak voor T40X 2 deuren breed  
Schuin dak voor T40X 3 deuren breed

Opzetkast voor T30X 1 deur breed  
Opzetkast voor T30X 2 deuren breed  
Opzetkast voor T30X 3 deuren breed  
Opzetkast voor T30X 4 deuren breed

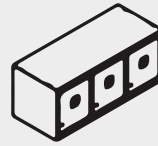

Opzetkast voor T40X 1 deur breed  
Opzetkast voor T40X 2 deuren breed  
Opzetkast voor T40X 3 deuren breed

Sokkel voor T30X 1 deur breed  
Sokkel voor T30X 2 deuren breed  
Sokkel voor T30X 3 deuren breed  
Sokkel voor T30X 4 deuren breed



Sokkel voor T40X 1 deur breed  
Sokkel voor T40X 2 deuren breed  
Sokkel voor T40X 3 deuren breed

#### Bank opties (frame zwart of grijs met blank hout)

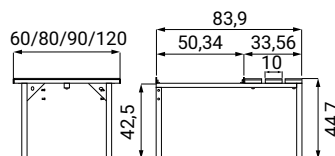

Kastbank voor T30X 2 deuren breed  
Kastbank voor T40X 2 deuren breed  
Kastbank voor T30X 3 deuren breed  
Kastbank voor T30X 4 deuren breed  
Kastbank voor T40X 3 deuren breed

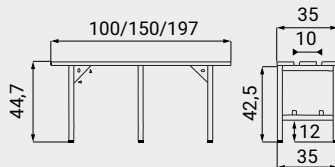

Bank 100cm breed  
Bank 150cm breed  
Bank 200cm breed

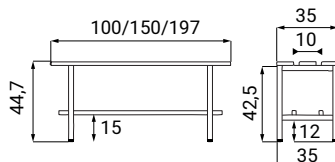

Bank 100cm breed met schoenenrek  
Bank 150cm breed met schoenenrek  
Bank 200cm breed met schoenenrek

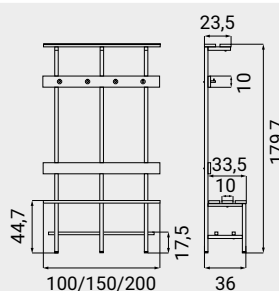
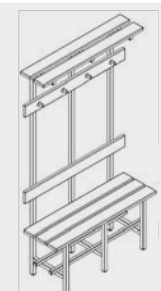

Bank met kleding houder 100cm breed  
Bank met kleding houder 150cm breed  
Bank met kleding houder 200cm breed

Dubbele bank met kleding houder 100cm breed  
Dubbele bank met kleding houder 150cm breed  
Dubbele bank met kleding houder 200cm breed

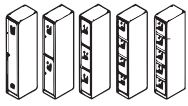
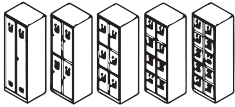
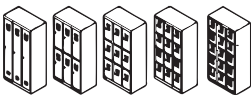
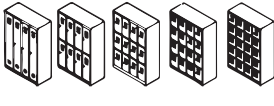
Lockerkast 1 deur breed	T30X 1M	bx dxh (cm)	T40X 1M	bx dxh (cm)
	T30X 1M1P	32,3 x 50 x 180	T40X 1M1P	42,1 x 50 x 180
	T30X 1M2P	32,3 x 50 x 180	T40X 1M2P	42,1 x 50 x 180
	T30X 1M3P	32,3 x 50 x 180	T40X 1M3P	42,1 x 50 x 180
	T30X 1M4P	32,3 x 50 x 180	T40X 1M4P	42,1 x 50 x 180
	T30X 1M5P	32,3 x 50 x 180	T40X 1M5P	42,1 x 50 x 180
Lockerkast 2 deuren breed	T30X 2M	bx dxh (cm)	T40X 2M	bx dxh (cm)
	T30X 2M1P	61,6 x 50 x 180	T40X 2M1P	81,2 x 50 x 180
	T30X 2M2P	61,6 x 50 x 180	T40X 2M2P	81,2 x 50 x 180
	T30X 2M3P	61,6 x 50 x 180	T40X 2M3P	81,2 x 50 x 180
	T30X 2M4P	61,6 x 50 x 180	T40X 2M4P	81,2 x 50 x 180
	T30X 2M5P	61,6 x 50 x 180	T40X 2M5P	81,2 x 50 x 180
Lockerkast 3 deuren breed	T30X 3M	bx dxh (cm)	T40X 3M	bx dxh (cm)
	T30X 3M1P	90,9 x 50 x 180	T40X 3M1P	120,2 x 50 x 180
	T30X 3M2P	90,9 x 50 x 180	T40X 3M2P	120,2 x 50 x 180
	T30X 3M3P	90,9 x 50 x 180	T40X 3M3P	120,2 x 50 x 180
	T30X 3M4P	90,9 x 50 x 180	T40X 3M4P	120,2 x 50 x 180
	T30X 3M5P	90,9 x 50 x 180	T40X 3M5P	120,2 x 50 x 180
Lockerkast 4 deuren breed	T30X 4M	bx dxh (cm)		
	T30X 4M1P	120,2 x 50 x 180		
	T30X 4M2P	120,2 x 50 x 180		
	T30X 4M3P	120,2 x 50 x 180		
	T30X 4M4P	120,2 x 50 x 180		
	T30X 4M5P	120,2 x 50 x 180		

In de code staat vermeld hoeveel deuren hoog de kast heeft. 1p staat voor 1 deur hoog, 2p voor 2 deurtjes hoog etc.

Metaalkleuren corpus



Metaalkleuren deuren

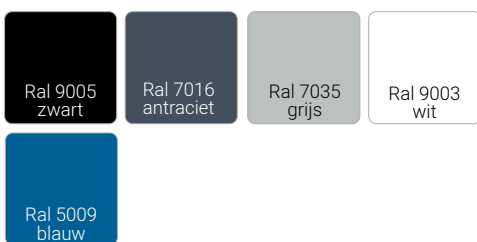

De lockerkast 1 of 2 deuren is standaard voorzien van gelaste ogen voor kledinghangers.

Opties (i.c.m. de kast te bestellen)



Standaard slot met dubbele sleutel, per deur  
Masterkey LLAVMA voor standaard slot

3-puntsluiting (met dubbele sleutel) geeft de deur boven en onder een extra vergrendeling (alleen bij hoge deur modellen 1P)



Sluiting tbv hangslot (excl. slot) per deur



Cijferslot, per deur



Muntslot (€1), per deur



Digitaal cijferslot, per deur



Pootjes 10cm hoog in kleur van de kast, set 4 stuks gelast incl. stelvoetjes





Modulaire melamine draaideurkasten in ongekende variaties en kleuren te configureren. Standaard voorzien van legborden, slot en melamine topblad en stelvoetjes. De kleuren van de Q4 kasten zijn perfect passend bij de overige meubels van Quadrifoglio zoals de bureaus, directie- en vergadertafels.

Stel zelf uw ideale kast samen passend in elk interieur.



#### Opties Q4 draaideurkasten



Plint 43cm breed in white, silver of shadow grey  
Plint 86cm breed in white, silver of shadow grey

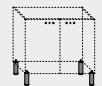

Ronde pootjes set van 4 stuks in white, silver of shadow grey  
Ronde tussenpootjes set van 2 stuks in white, silver of shadow grey

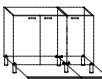

Rechthoekige pootjes set van 4 stuks in white, silver of shadow grey  
Rechthoekige tussenpootjes set van 2 stuks in white, silver of shadow grey  
Rechthoekige pootjes set van 4 stuks in chrome  
Rechthoekige tussenpootjes set van 2 stuks in chrome  
(Voeg afwerkprofiel toe bij de ronde of rechthoekige pootjes)

Softclose op de deuren  
Uittrekframe tbv kast 86cm voor A4 en foliomappen  
3-punts sluiting tbv kast 2-deurs (niet achteraf te monteren)

#### Greepjes

- Look kunststof greepje (standaard) in wit-JB, zilver-J of shadow grey-JR  
- Zen metalen greepje (optie) in wit-A, zilver-Z, shadow grey-Q of chrome-Y



standaard - Look

Zen - optioneel

**Kast 86cm hoog**      **bx dxh (cm)**

	1x kast H86	86 x 45 x 86
--	-------------	--------------

	2x kast H86	172 x 45 x 86
--	-------------	---------------

	3x kast H86	258 x 45 x 86
--	-------------	---------------

**Kast 131cm hoog**      **bx dxh (cm)**

	1x kast H131	86 x 45 x 131
--	--------------	---------------

	2x kast H131	172 x 45 x 131
--	--------------	----------------

	3x kast H131	258 x 45 x 131
--	--------------	----------------

**Kast 214cm hoog**      **bx dxh (cm)**

	1x kast H214	86 x 45 x 214
--	--------------	---------------

	2x kast H214	172 x 45 x 214
--	--------------	----------------

	3x kast H214	258 x 45 x 214
--	--------------	----------------



Structuur kast en legborden



--	--	--



Deuren 18mm melamine, top en zijpanelen 18 of 30mm melamine

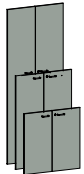
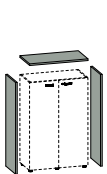

--	--	--	--	--	--	--	--	--

Deuren lak, top en zijpanelen 18mm lak

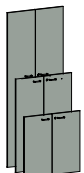
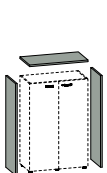

Deuren 19mm houtfineer, top en zijpanelen 30mm fineer

--	--	--

Deuren 19mm leder, top en zijpanelen 30mm leder

--	--	--	--



Metalen kasten perfect passend bij uw Quadrifoglio inrichting, zowel bij T45 als X7 en X8.

De kasten hebben een prachtig dunne metalen omlijsting in white, silver of shadow grey. De deuren zijn naar wens uitgevoerd in leder, fineer, melamine of lak en standaard voorzien van slot en softclose. Inclusief metalen legborden in de kleur van de structuur. Alle kasten worden geleverd met 4 stelvoetjes. Optioneel verkrijgbaar met plint of vierkante chromen pootjes.





## Q4 metalen kast



2-deurs kast incl softclose en 1 legbord  
Maat 87 x 44,6 x 87h

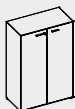

2-deurs kast incl softclose en 2 legborden  
Maat 87 x 44,6 x 132h

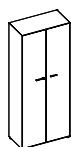

2-deurs kast incl softclose en 4 legborden  
Maat 87 x 44,6 x 215h

## Opties metalen kasten

Set á 4 pootjes vierkant chroom 7,5 x 7,5 x 4h

Plint 86cm in white (I), silver (A) of shadow grey (R)



## Structuur kast en legborden

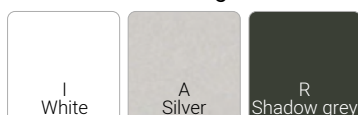
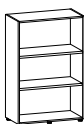

## Deuren 18mm melamine

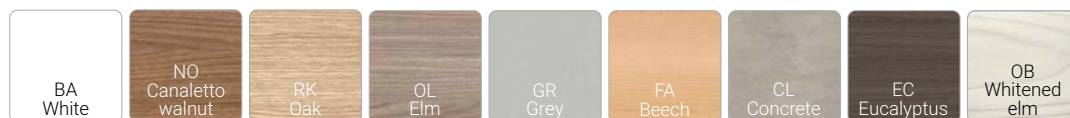
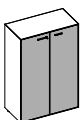

## Deuren 18mm lak

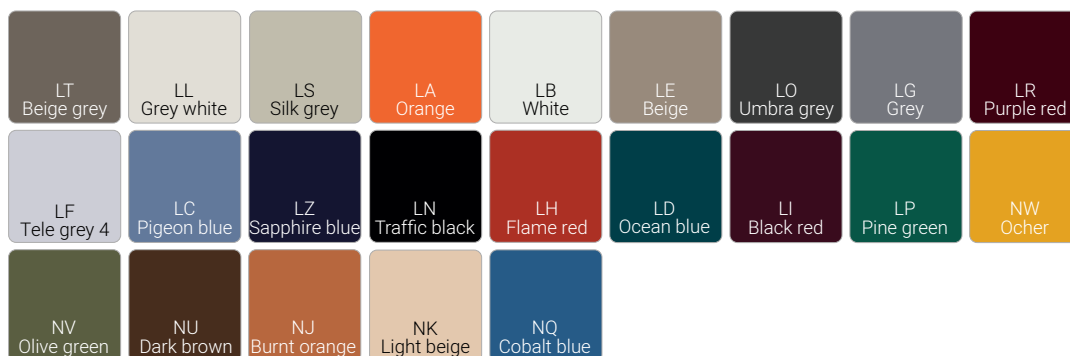

## Deuren 19mm finer



## Deuren 19mm leder



## Greepjes

- Look kunststof greepje (standaard) in white-JB, silver-J of shadow grey-JR
- Zen metalen greepje (optie) in white-A, silver-Z, shadow grey-Q of chrome-Y



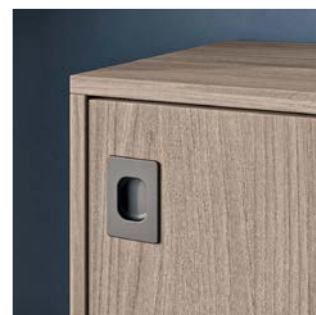

Fraaie schuifdeurkasten volledig uitgevoerd in melamine, en perfect te combineren met de meubellijnen van Quadrifoglio. Aan de achterzijde heeft deze kast een vlakke melamine afwerking, perfect om bijvoorbeeld vrij in de ruimte te plaatsen of voor een glazen wand.

De deuren zijn uitgevoerd met een komgreepje in white (I), silver (A) of shadow grey (R) en voorzien van slot met dubbele kniksleutel. Standaard voorzien van melamine legborden en een centraal tussenschot in de kleur van de kast.

#### Q4 schuifdeurkast bxdxh (cm)



Schuifdeurkast incl 1 legbord (per kastdeel)  
Maat 120 x 42,6 x 86



Schuifdeurkast incl 2 legborden (per kastdeel)  
Maat 120 x 42,6 x 131



Schuifdeurkast incl 1 legbord (per kastdeel)  
Maat 160 x 42,6 x 86



Schuifdeurkast incl 2 legborden (per kastdeel)  
Maat 160 x 42,6 x 131

#### Opties Q4 schuifdeurkast bxdxh (cm)



Plint 120 x 41,6 x 2,7  
in white, silver of shadow grey

Plint 160 x 41,6 x 2,7  
in white, silver of shadow grey



#### Kleur corpus, deuren en legborden

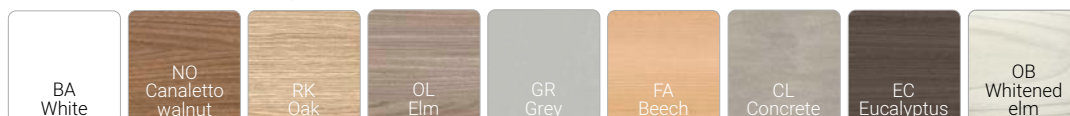

# Q4 LOCKERKASTEN



De lockerkasten van Quadrifoglio zijn in diverse maatvoeringen configureerbaar. Maak uw keuze uit 4 hoogtes: 2, 3, 4 of 5 vaks. De lockerdeurtjes zijn leverbaar in diverse kleuren en voorzien van een slot met 2 kniksleutels. Binnenmaat per locker: 39x41x39cm (bxdxh). Alle kasten zijn uitgevoerd met verstelbare pootjes tbv kleine oneffenheden in de vloer.



## Q4 lockerkast bxdxh (cm)

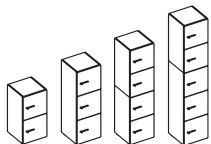

- 2-vaks afm. 43 x 44,6 x 86
- 3-vaks afm. 43 x 44,6 x 127,7
- 4-vaks (2+2) afm. 43 x 44,6 x 169
- 5-vaks (3+2) afm. 43 x 44,6 x 211,1

Deurtjes en top leverbaar in 18mm melamine of lak (kleuren zie pag 175)



## Opties Q4 lockerkast bxdxh (cm)

Look kunststof greepje (standaard) in white-JB, silver-J of shadow grey-JR  
Zen metalen greepje (optie) in white-A, silver-Z, shadow grey-Q of chrome-Y

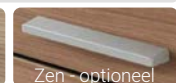

Plint 43 x 43 x 3 in white, silver of shadow grey  
Plint 86 x 43 x 3 in white, silver of shadow grey



## Kleuren corpus



## Deuren melamine

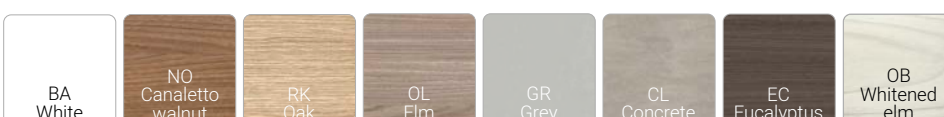



Libreria boekenkasten met de luxe 38mm dikke modules en vrij in de ruimte te plaatsen. Modulair dus eindeloos te combineren.

Kies uit de vele melamine of lakkleuren en maak uw kast compleet met de optionele deuren of de opvallende bibliotheek-ladder.



Libreria voorbeeld configuraties	bx dxh (cm)
	5 x 47 breed open 239 x 44 x 215/256
	47-90-47-90-47 open 325 x 44 x 215/256
	5 x 90 breed open 454 x 44 x 215/256
	8 x 47 breed open 380 x 44 x 215/256
	8 x 90 breed open 724 x 44 x 215/256



Melamine modules, eindpanelen en achterwand

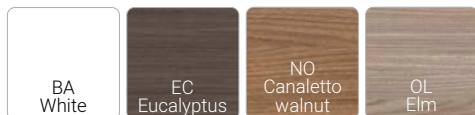

Glazen deurtjes frosted met omlijsting

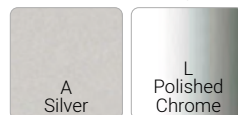

Metaalkleuren

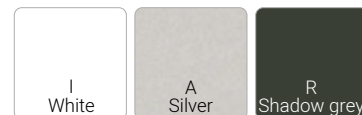

Deuren 18mm melamine

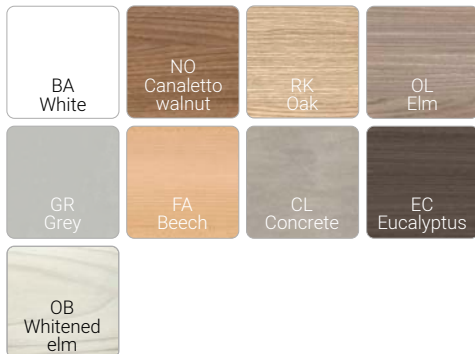

Deuren 18mm lak



Deuren 19mm leder



Greepjes

- Look kunststof greepje (standaard) in white-JB, silver-J of shadow grey-JR
- Zen metalen greepje (optie) in white -A, silver-Z, shadow grey-Q of chrome-Y

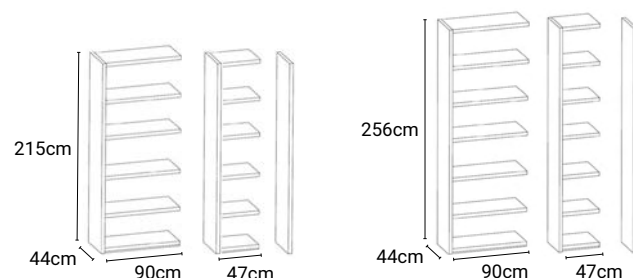

Module en eindpaneel 215cm      Module en eindpaneel 256cm  
Achterwand (min. 1x verplicht ivm stevigheid)



Boiserie kasten zijn leverbaar in 2 hoogtes (135 en 219cm) en modulair uit te breiden. De kast bestaat uit een 18mm dikke achterwand met metalen staanders in shadow grey, gepolijst aluminium, mat wit of glossy wit. De planken zijn uitgevoerd in dubbel gecoat wit glas en kunnen eenvoudig aangevuld worden met diverse deuren en afsluitpanelen. Hierdoor creëert u zelf de ideale kast voor uw ruimte!

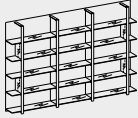

Boiserie modellen		bx dxh (cm)	Code
	Boiserie opstelling met 2 modules. set afsluitende zijpanelen inbegrepen	235 x 36 x 135	BOM23
	Boiserie opstelling met 3 modules. set afsluitende zijpanelen inbegrepen	327 x 36 x 135	BOM32
	Boiserie opstelling met 2 modules. set afsluitende zijpanelen inbegrepen	235 x 36 x 219	BOS23
	Boiserie opstelling met 3 modules. set afsluitende zijpanelen inbegrepen	327 x 36 x 219	BOS32

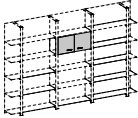
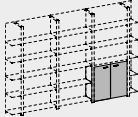
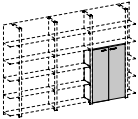
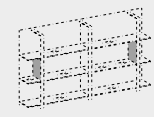
Optionele deuren en zijpanelen		bxh (cm)
	Set deurtjes, h45cm zonder slot (incl. greepjes Zen)	86 x 45
	* Set deuren, h83cm incl. slot (incl. greepjes Zen)	86 x 83
	* Set deuren, h127cm incl. slot (incl. greepjes Zen)	86 x 127
	Set afsluitende zijpanelen 2 stuks (bij deuren per glazen plank)	32 x 39



\* Deuren uitsluitend van onderaf te plaatsen.

Glazen planken



Kleur metalen standers



Melamine achterwanden, deuren en zijpanelen



Lederen deuren



Lakkleuren deuren, achterwanden en zijpanelen





E-10 hoekbureau met aanbouw links, uitvoering finer American walnut met poten in lak LO en blad met lederen inleg antraciet.





Een directiekamer zal altijd een speciale plek zijn voor u als ondernemer. De uitstraling moet passen bij u als persoon maar ook bij de sfeer van het bedrijf. Wij helpen u graag met deskundig advies en een breed assortiment directiemeubelen.



T45 hoekbureau (T4BED200) in elm en white.  
Kast Libreria in lak LO.



## Quadrifoglio Group

T45 van Quadrifoglio wordt gekenmerkt door haar stoere voorkomen met 38mm dikke bladen en 45 graden verstekhoeken.

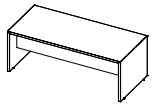
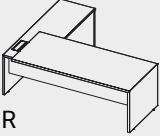
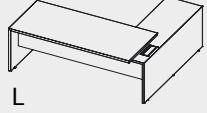
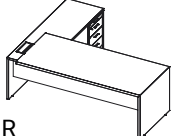
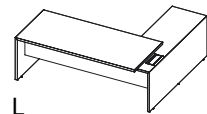
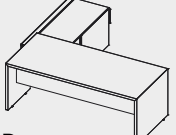
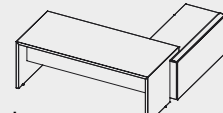
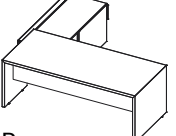
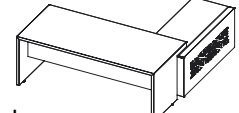
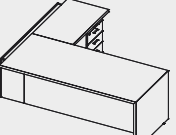
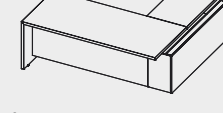
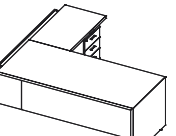
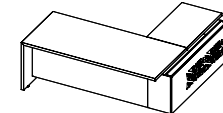
T45 bureau		bx dx h (cm)	Code
	Bureau recht	180 x 90 x 76,5 200 x 90 x 76,5	T4PO0180 T4PO0200
	Bureau met aanbouw rechts met kabelklep klein en cpu houder	200 x 194 x 76,5 220 x 194 x 76,5	T4MSD180 T4MSD200
	Idem met aanbouw links	200 x 194 x 76,5 220 x 194 x 76,5	T4MSS180 T4MSS200
	Bureau met aanbouw (rechts) en ingebouwd 3+1 ladenblok, met kabelklep klein en cpu houder	200 x 194 x 76,5 220 x 194 x 76,5	T4MCD180 T4MCD200
	Idem met aanbouw links	200 x 194 x 76,5 220 x 194 x 76,5	T4MCS180 T4MCS200
	Bureau met aanbouw (rechts) en schuifdeur-kast incl. lade, kabelklep groot en melamine achterwand	192 x 204 x 76,5 212 x 204 x 76,5	T4SMD180 T4SMD200
	Idem met aanbouw links	192 x 204 x 76,5 212 x 204 x 76,5	T4SMS180 T4SMS200
	Bureau met aanbouw (rechts) en schuifdeurkast incl. lade, kabelklep groot en metalen sier achterwand	192 x 204 x 76,5 212 x 204 x 76,5	T4SED180 T4SED200
	Idem met aanbouw links	192 x 204 x 76,5 212 x 204 x 76,5	T4SES180 T4SES200
	Bureau met aanbouw (rechts) en doorlopend aanbouwblad met ingebouwd 3+1 ladenblok, kabelklep groot en melamine achterwand	192 x 190 x 76,5 212 x 190 x 76,5	T4BMD180 T4BMD200
	Idem met aanbouw links	192 x 190 x 76,5 212 x 190 x 76,5	T4BMS180 T4BMS200
	Bureau met aanbouw (rechts) en doorlopend aanbouwblad met ingebouwd 3+1 ladenblok, kabelklep groot en metalen sier achterwand	192 x 190 x 76,5 212 x 190 x 76,5	T4BED180 T4BED200
	Idem met aanbouw links	192 x 190 x 76,5 212 x 190 x 76,5	T4BES180 T4BES200

Greepjes: Standaard in Zen mat wit.  
Zen zilver of chroom optioneel zonder meerprijs

**Opties**

Softclose op ladenblok

Metalen lades (ipv standaard melamine)

Kabelkorf over lengte onderzijde bureaublad



Melamine bureau topladen en zijpanelen

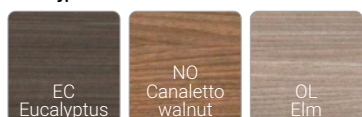

Melamine aanbouw en zichtschot

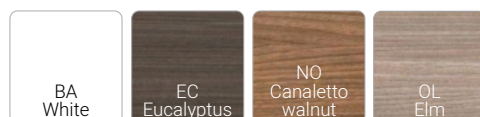

Kabelklep klein en CPU houder

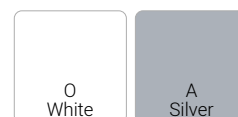

Kabelklep groot en achterwand metaal





T45 meeting tafels met de kenmerkende dikke rand (85mm) leverbaar in diverse kleuren en met 2 verschillende onderstellen.

Bladen inclusief 2-zijdig te openen kabeldoorvoerlepel 45x12cm met kabelbak. De kolompoten zijn standaard voorzien van stelvoetjes en een kabeldoorvoerdop.



T45 meeting 280x140cm met kolompoten in OL elm



T45 meeting		bxdxh (cm)	Code
	Meeting tafel, 140 x 140 melamine poot 55 x 55	140 x 140 x 76,5	T4RM0140
	Meeting tafel, 280 x 140 melamine poten 55 x 55	280 x 140 x 76,5	T4RM0280
	Meeting tafel, 420 x 140 melamine poten 55 x 55	420 x 140 x 76,5	T4RM0420
	Meeting tafel, 560 x 140 melamine poten 55 x 55	560 x 140 x 76,5	T4RM0560
	Meeting tafel, 280 x 140 metalen ringpoten 9,4b x 3d	280 x 140 x 76,5	T4RE0280
	Meeting tafel, 420 x 140 metalen ringpoten 9,4b x 3d	420 x 140 x 76,5	T4RE0420
	Meeting tafel, 560 x 140 metalen ringpoten 9,4b x 3d	560 x 140 x 76,5	T4RE0560

Hoogte T45 blad bovenzijde 76,5cm en onderzijde rand 68cm

T45 meeting opties		Code
	Kabelkorf tbv doorvoer tussenruimte kolompoten	COGRU100
	Kabelkorf tbv doorvoer tussenruimte metalen poten	COGRV140

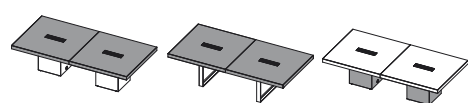

Melaminekleuren bladen en kolompoten

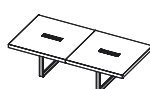
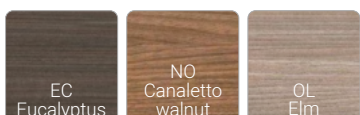

Metaalkleuren kabelklep  
en ringpoten





X5 hoekbureau links met lage schuifdeurkast en kabelmanagement, blad en deuren in kleur OL elm, kast in TA antraciet en metaalkleur shadow grey.

X5 is ontworpen om uw directiekamer perfect in te kunnen richten door haar eindeloze configuraties en tijdloze uitstraling. Metalen onderstel in wit of shadow grey en tafelblad in 8 kleuren melamine. X5 is ook leverbaar als werkplek en praktische duo-bench.





Designed by  
Polloni

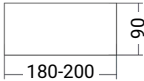
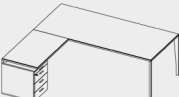
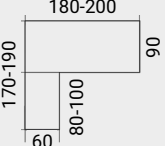
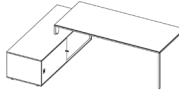
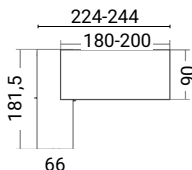
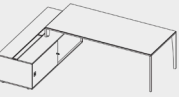
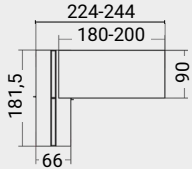

**Quadrifoglio Group**

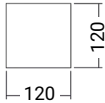

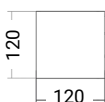
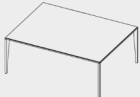
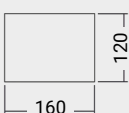
X5 bureaus, enkele voorbeelden		bxdxh (cm)	Code
		X5 bureau recht 180 x 90 x 75 200 x 90 x 75	X5L0119 X5L0120
		X5 hoekbureau met ladenblok 3+1 PVC laden return links of rechts (L of R) 180 x 170 x 75 200 x 170 x 75 180 x 190 x 75 200 x 190 x 75	X5L2287 (L) / X5L2187 (R) X5L2207 (L) / X5L2107 (R) X5L2289 (L) / X5L2189 (R) X5L2209 (L) / X5L2109 (R)
		X5 hoekbureau met lage schuifdeurkast (h56 x d66) return links of rechts 224 x 181,5 x 75 244 x 181,5 x 75	X5BA9180 X5BA9200
		X5 hoekbureau met lage schuifdeurkast en kabelmanagementrail return links of rechts 224 x 181,5 x 75 244 x 181,5 x 75	X5BB9180 X5BB9200

X5 meeting		b x d x h	Code
		X5 meetingtafel 120 120 x 120 x 75	X5LT112
		X5 meetingtafel 120 aanbouw 120 x 120 x 75	X5LT12A
		X5 meetingtafel 160 160 x 120 x 75	X5LT116
		X5 meetingtafel 160 aanbouw 160 x 120 x 75	X5LT16A

Kleur metalen poten en kabelklep

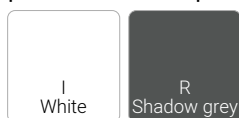

Kleuren corpus van kast en stand ladenblok

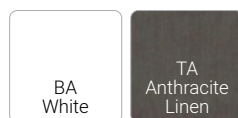

Kleuren melamine bladen, zichtschotten, ladenblokken en kasten





X7 meeting 140x140, blad eucalyptus en frame chroom, daarachter X7 hoekopstelling open links.  
Stoelen Diva soft en hanglampen Mirage

X7 meubilair van Quadrifoglio, Italiaans design voor directiekamer en vergaderruimte.

Vakmanschap in metaalbewerking, de fraaie poten in chroom, wit of shadow grey en de 10mm dunne geprofileerde bladen in melamine, gelakt mdf of gecoat glas.

Aantrekkelijke accenten zoals de chromen bladhoeken en het slimme kabelmanagement maken van dit praktische meubel een ware eye-catcher.







Designed by  
Polloni

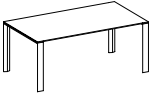

**Quadrifoglio Group**

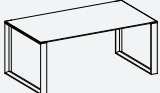
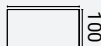
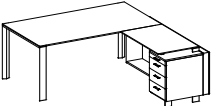
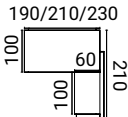
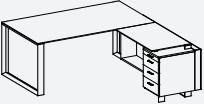
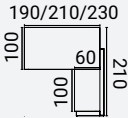

X7 bureau		bx dxh (cm)	
	4-poots recht	180/200/220 	X7 open 180 x 100 x 75 X7 open 200 x 100 x 75 X7 open 220 x 100 x 75
	Ringpoot recht	180/200/220 	X7 closed 180 x 100 x 75 X7 closed 200 x 100 x 75 X7 closed 220 x 100 x 75
	4-poots RH	190/210/230 	X7 hoekbureau open 190 x 210 x 75 X7 hoekbureau open 210 x 210 x 75 X7 hoekbureau open 230 x 210 x 75
	Ringpoot RH	190/210/230 	X7 hoekbureau closed 190 x 210 x 75 X7 hoekbureau closed 210 x 210 x 75 X7 hoekbureau closed 230 x 210 x 75

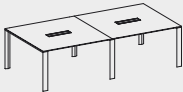
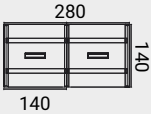
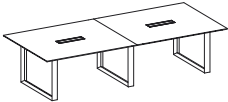
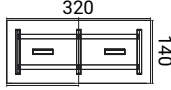
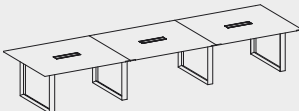
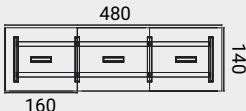
X7 meeting		bx dxh (cm)	
		140 	X7 meeting open 140 x 140 x 75 (incl. kabelklep) Ook leverbaar in maat 160 x 140 cm
		280 	X7 meeting open 280 x 140 x 75 (incl. 2x kabelklep) Ook leverbaar in maat 320 x 140 cm
		320 	X7 meeting closed 320 x 140 x 75 (incl. 2x kabelklep)
		480 	X7 meeting closed 480 x 140 x 75 (incl. 3x kabelklep)

Bij X7 meeting met closed poten svp rekening houden met de ruimte tussen de poten en plaatsing van de stoelen.



- Opties**
- Zichtschot 35cm hoog tbv bureau 200cm
  - Zichtschot 35cm hoog tbv bureau 220cm

- Opties**
- Kabelkorf 170cm tbv bureau 200/220
  - Kabelkorf 90cm tbv gekoppelde vergadertafels

**Kleur metalen poten en kabelklep**



**Kleuren melamine bladen, zichtschotten, ladenblokken en kasten**



**Kleuren gelakte bladen, zichtschotten, ladenblokken en kasten**





X8 hoekbureau met aanbouw schuifdeurkast  
231x224x75h, frame en designpaneel matwit  
en melamine OL elm.  
Stoel Diva soft executive high back en Diva  
soft visitor sledemodel.

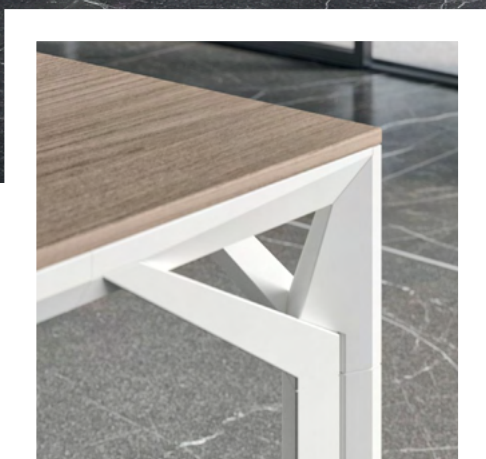

Designed by  
Polloni





**Quadrifoglio Group**

De exclusieve directie-lijn van het Italiaanse  
Quadrifoglio, strak en puur design.

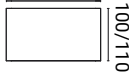
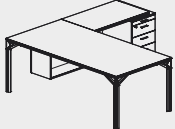
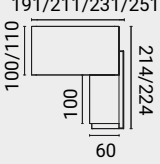
Organisch vormgegeven frames in matwit of  
shadow grey met fraaie 10mm geprofileerde  
bladen in melamine, glas of gelakt mdf.

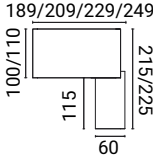
X8 bureau		bx dxh (cm)
	180/200/220/240 	180 x 100 x 75 200 x 100 x 75 220 x 110 x 75 240 x 110 x 75
	191/211/231/251 	191 x 214 x 75 211 x 214 x 75 231 x 224 x 75 251 x 224 x 75

	189/209/229/249 	189 x 215 x 75 209 x 215 x 75 229 x 225 x 75 249 x 225 x 75
---	--	--

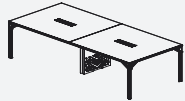
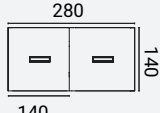
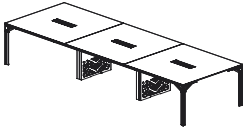
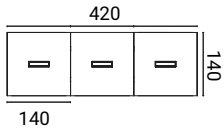
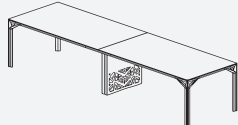
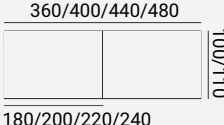
X8 meeting		bx dxh (cm)
	140 	X8 meeting 140x140cm (incl. 1x kabelklep) Ook leverbaar in maat 160x140cm 140 x 140 x 75
	280 	X8 meeting 280x140cm (incl. 2x kabelklep) Ook leverbaar in maat 320x140cm 280 x 140 x 75
	420 	X8 meeting 420x140cm (incl. 2x kabelklep) Ook leverbaar in maat 480x140cm 420 x 140 x 75
	360/400/440/480 	X8 meeting met tussenpoot 360 x 100 x 75 400 x 100 x 75 440 x 100 x 75 440 x 110 x 75 480 x 110 x 75

Kleur metalen poten en kabelklep

O White    R Shadow grey



SCAN VOOR PRIJSLIJST

Kleuren melamine bladen, zichtschootten, ladenblokken en kasten

BA White    EC Eucalyptus    NO Canaletto walnut    OL Elm

Kleuren gelakte bladen, zichtschootten, ladenblokken en kasten

LT Beige grey	LL Grey white	LS Silk grey	LA Orange	LB White	LE Beige
LO Umbra grey	LG Grey	LR Purple red	LF Tele grey 4	LC Pigeon blue	LZ Sapphire blue
LN Traffic black	LH Flame red	LD Ocean blue	LI Black red	LP Pine green	NW Ocher
NV Olive green	NU Dark brown	NJ Burnt orange	NK Light beige	NQ Cobalt blue	

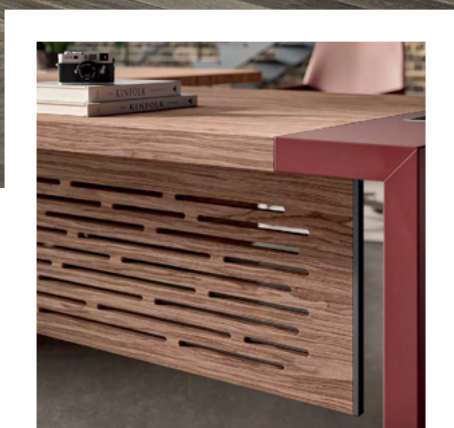

E-10 van Quadrifoglio, vorm en materiaal creëren samen een tijdloze inrichting.

Wangenpoten met fraaie verstekhoeken in finer of smaakvolle lakkleur, compleet gemaakt met een houten zichtschoot of lederen inleg in het tafelblad. Voor het wegwerken van uw kabels is elk bureau voorzien van praktische kabelkleppen.



**Quadrifoglio Group**



**E-10 recht bureau**

**bx dx h (cm)**

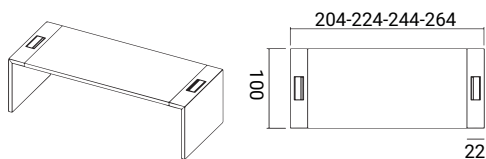

E-10 bureau recht, blad in houtfineer optioneel met lederenleg, wangenpoten in lak of fineer incl. kabelklep met borstel. Optioneel zichtschot halfhoog of geheel in lak of fineer.

- 204 x 100 x 76
- 224 x 100 x 76
- 244 x 100 x 76
- 264 x 100 x 76

**E-10 hoekbureau links of rechts**

**bx dx h (cm)**

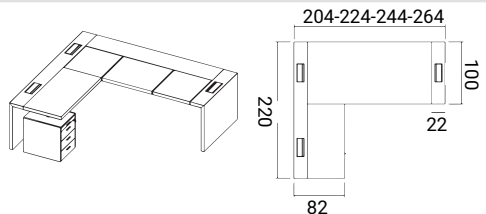

E-10 hoekbureau in houtfineer blad optioneel met lederen inlegdeel, incl. praktische kabelkleppen in geborsteld chroom. De aanbouw bestaat uit een fraaie lak of fineer wangenpoot en vast fineer ladenblok met slot.

- 204 x 220 x 76
- 224 x 220 x 76
- 244 x 220 x 76
- 264 x 220 x 76

X-10 fineer ladenblok verrijdbaar zie pagina 198

**E-10 meeting vergadertafels**

**bx dx h (cm)**

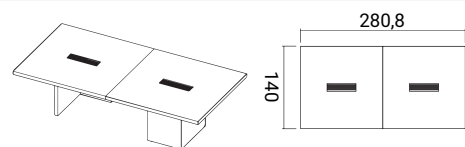

E-10 vergadertafels, blad in delen 140x140cm houtfineer optioneel met lederenleg, incl. kabelklep met borstel, L-poten in lak of fineer.

- 280 x 140 x 76
- 420 x 140 x 76
- 560 x 140 x 76

Lakkleuren zie pag 195

**Kleur metaal**



**Kleur houtfineer**

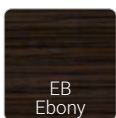

**Kleur lederenleg**

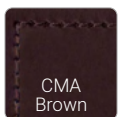
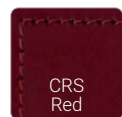

**Greepjes**





### X-10 bureau recht

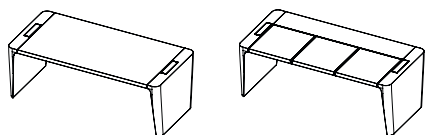

X-10 bureau recht in houtfineer optioneel met lederen inlegdeel, incl. 2x kabelklep in geborsteld chroom.

### bx dxh (cm)

190 x 100 x 76  
210 x 100 x 76  
230 x 100 x 76  
250 x 100 x 76

### X-10 hoekbureau links of rechts

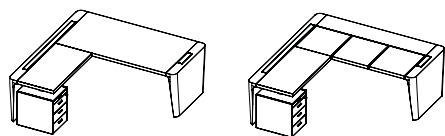

X-10 hoekbureau in houtfineer optioneel met lederen inlegdeel, incl. 1x kabelklep en 1x kabelklep groot in geborsteld chroom. De aanbouw bestaat uit een fraaie fineer wangenpoot en een vast ladenblok met slot.

### bx dxh (cm)

190 x 220 x 76  
210 x 220 x 76  
230 x 220 x 76  
250 x 220 x 76

### X-10 ladenblok

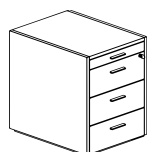

X-10 verrijdbaar ladenblok in houtfineer, 3 laden met slot en aparte pennlade met chromen greepjes, verborgen zwenkwieien en lades anti-tilt met metalen binnenwerk en softclose.

### bx dxh (cm)

58,5 x 45,4 x 58





X-10, de top in directiemeubilair, vult uw ruimte met Italiaans vakmanschap. Vervaardigd van fraaie elementen mdf met prachtig houtfineer voor optimale kwaliteitsbeleving. De rondingen in de wangepoten geven de X-10 een exclusieve look, compleet gemaakt met details in geborsteld rvs en optionele lederen delen in het tafelblad.



**X-10 meeting**

**bx dx h (cm)**

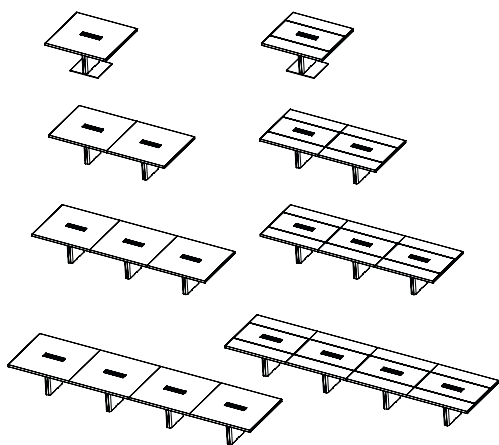

X-10 meetingtafel in delen van 140x140cm met elegante fineer kolompoet. De losse tafel is voorzien van een zware voetplaat in geborsteld chroom. Bladen incl. kabelklep in houtfineer met kopse kant in geborsteld chroom, optioneel met fraaie lederen inleg.

141 x 140 x 77  
281 x 140 x 76  
421 x 140 x 76  
561 x 140 x 76

**X-10 koffietafel**

**bx dx h (cm)**

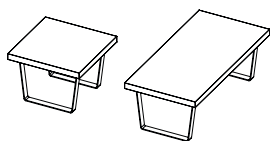

X-10 koffietafel met blad in fineer en poten in geborsteld chroom

60 x 60 x 42  
120 x 60 x 42



**Kleur metaal**



**Kleur houtfineer**

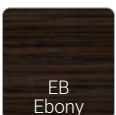

**Kleur lederenleg**

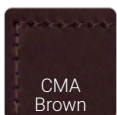
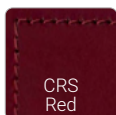

**Greepjes**

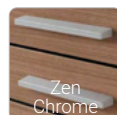



Sittland

Un modello di sostenibilità per Sittland

**ECON**

Our sustainable approach to design





Zitten doen we vandaag de dag met veel aandacht voor elke toepassing. Denk aan ontspannen ontmoeten in fraaie modulaire zit-elementen of een informeel overleg in hoge akoestische zitcellen. Belangrijk is om bij iedere functie de juiste keuze te maken. Laat u door ons adviseren over de ideale oplossing.

Een bureaustoel moet uiteraard voldoen aan de strenge eisen op het gebied van ergonomie en functionaliteit, maar bovenal moet de stoel goed zitten! Van NPR tot C2C, wij nemen u graag mee langs alle uitvoeringen.

Voor uw vergaderruimte heeft u een ruime keuze aan comfortabele sledestoelen of draaibare meetingstoelen, die zich desgewenst met een self-return mechaniek terugdraaien in de juiste stand.

Dan de directiestoel. Deze dient comfortabel te zijn, van topkwaliteit en qua uitstraling perfect passend bij uw inrichting. Het blijft zitten, maar dan graag goed, gevarieerd en passend bij uw wensen.

Vega meeting  
Tafel Tmeeting 1  
Hanglamp Planet



SW-1 bureaustoel met hoogte en breedte verstelbare 4D armleggers.

SW-1, ergonomische bureaustoel volgens NEN - EN 1335 voor optimaal zitcomfort. Voorzien van gebruiksvriendelijk 2-hendel synchroonmechaniek anti-panic in 3 posities te blokkeren. Standaard 2D armleggers met zachte PU softpad, optioneel leverbaar met 4D armleggers. Voetkruis zwart kunststof met NPR gasveer en 65mm PHD zwenkwielen voor alle vloeren.

Gestoffeerde rug en zitting voorzien van vormvast CFK-vrij koudschuim en zeer slijtvaste stof (100.000 Martindale) in duotoon met lijnstiksel.



Lichaamsgewicht is traploos instelbaar middels een slinger en de schuifzitting zorgt voor de juiste zithouding.



De rugleuning is met een knop in hoogte verstelbaar.



# SW-1 MESH



VOORRAAD



GARANTIE



ARBO KEUR



MONTAGE

203

SW-1 mesh, ergonomische bureaustoel volgens NEN - EN 1335 voor optimaal zitcomfort. Standaard met gebruiksvriendelijk 2-hendel synchroniemechaniek anti-panic in 3 posities te blokkeren. Lichaamsgewicht is traploos instelbaar middels een slinger en de schuifzitting zorgt voor de juiste zithouding. Gestoffeerde zitting voorzien van vormvast CFK-vrij koudschuim en zeer slijtvaste stof (100.000 Martindale) in duo-toon met lijnstiksel.



De rugleuning is uitgevoerd in slijtvaste zwarte mesh en voorzien van een hoogte verstelbare lendensteun.



Voetkruis zwart kunststof met NPR gasveer en 65mm PHD zwenkwielen voor alle vloeren.



Standaard 2D armleggers met zachte PU softpad, optioneel leverbaar met 4D armleggers.



SW-1 mesh bureaustoel met 2D armleggers.



Zeer professionele bureaustoel die voldoet aan de strengste NPR normen.

Compleet geleverd met aluminium gepolijst voetkruis en 4D armleggers.  
Keuze uit een gestoffeerde of mesh rug.  
TUV NPR testrapporten beschikbaar.



Custom NPR



Hoogte verstelbare rugleuning



Breedte verstelbare armleggers en zithoek instelbaar



4D armleggers met zachte PU top



Draibare armleggers



Schuifbare armleggers



VOORRAAD



GARANTIE



ARBO KEUR



MONTAGE

**Custom NPR**

- Aluminium gepolijst voetkruis met universele 55mm wielen
- Koudschuim foam in gestoffeerde delen
- Zwarte stof 100.000 Martindale
- Rug in hoogte verstelbaar
- Schuifzitting 10cm
- 2 hendel synchronmechisme
- Zitting neigbaar met free-float functie
- 4D armleggers met zachte PU top
- Gecertificeerd NPR 1813 (testrapport beschikbaar)
- Optioneel PHD 65mm wielen voor harde vloeren



Custom NPR Mesh

**Model**

Custom NPR

Custom NPR Mesh



Custom Pro NPR voor optimaal dynamisch en ergonomisch zitten. Deze stoelen voldoen aan de strengste NPR normen.

Compleet geleverd met aluminium gepolijst voetkruis, rugsupport en 4D armleggers. Keuze uit een ranke ademende gestoffeerde of mesh design rug. TUV NPR testrapporten beschikbaar.



Custom Pro NPR

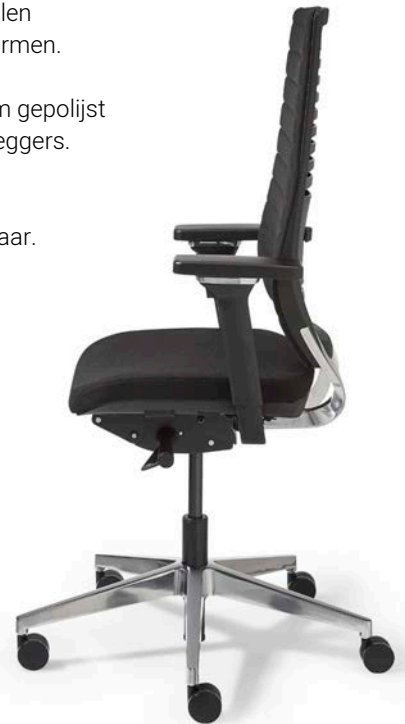

Hoogte verstelbare lendensteun



Geavanceerd synchroon mechaniek



4D armleggers met zachte PU top



Draaibare en schuifbare armleggers



Verstelbare hoofdsteun (optioneel)



VOORRAAD



GARANTIE



ARBO KEUR



MONTAGE

**Custom Pro NPR / Custom Pro NPR Mesh**

- Aluminium gepolijst voetkruis met universele 55mm wielen
- Ergonomische bureaustoel volgens NPR 1813
- Uitgevoerd met een fantastisch lopend autoweight synchronmechisme
- In 4 posities te blokkeren met terugslagbeveiliging
- Diepte instelling d.m.v. 10cm schuifzitting
- Lichaamsgewicht fijnafstelling d.m.v. draaiknop onder mechaniek
- 4D verstelbare armleggers met PU top
- Zitting van hoogwaardige CFK-vrije koudschuim
- Rug uitgevoerd in stof of met een netweave stoffering
- Lendensteun in hoogte te verstellen
- Zitting leverbaar in zwarte stoffering met 100.000 martindale
- Optioneel PHD 65mm wielen voor harde vloeren



Custom Pro NPR Mesh

**Model**

Custom Pro NPR

Custom Pro NPR Mesh



Custom Thor NPR met fraai gestikte zitting en rug voldoet aan de strengste NPR normen. Compleet geleverd met zwart metalen voetkruis met handige voetsteunen, 4D armleggers en lendensteun met opblaasbare diepteverstelling.



## Custom Thor NPR met 4D armleggers

### Getoond:

Follow Desk 299F large in kleur zand RAL 7044 met blad 160x80 Q4 eucalyptus. Ladenblok Q4 melamine 3-laden in eucalyptus.



Handige opblaasbare diepteverstelling lendensteun

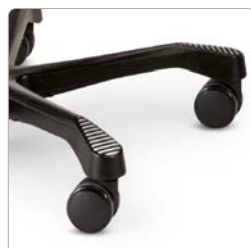

Voetkruis metaal met voetsteunen



Geavanceerd synchroon mechaniek



4D armleggers met zachte PU top



Draaibare en schuifbare armleggers





VOORRAAD



GARANTIE



ARBO KEUR



MONTAGE

### Custom Thor NPR

- Zwart metalen voetkruis met zachte 60mm wielen (voor alle vloeren)
- Ergonomische bureaustoel volgens NPR 1813
- Uitgevoerd met een fantastisch lopend autoweight synchroonmechanisme
- In 4 posities te blokkeren met terugslagbeveiliging
- Diepte instelling d.m.v. 10cm schuifzitting
- Lichaamsgewicht fijnafstelling d.m.v. draaiknop onder mechaniek
- 4D verstelbare armleggers met PU top
- Zitting en rug van hoogwaardige CFK-vrije koudschuim
- Rugleuning in hoogte te verstellen
- Lendensteun met opblaasbare diepteverstelling
- Gestoffeerd in Gabriel Medley 6099 (75.000 Martindale)

**Model**

Custom Thor NPR



## sitland

Design by  
Bertolini-Ferrarese-Scagnellato

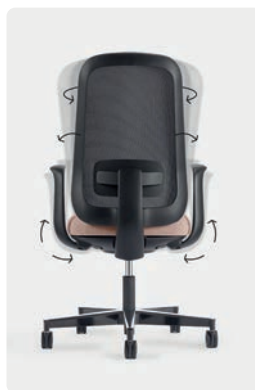
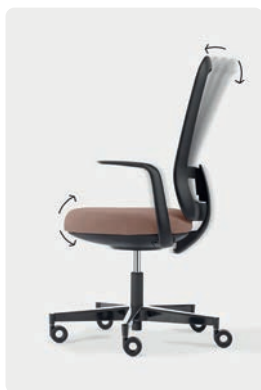

Our sustainable approach to design

Skate, een actieve bureaustoel met een dynamisch karakter.  
Geïnspireerd op het principe van een skateboard, met actieve zitting die zich aanpast aan uw bewegingen.

Leverbaar in 2 versies: met dynamische vaste zitting en met synchro mechaniek met schuifzit waarbij de bediening fraai onder de zitting verwerkt is.  
Standaard geleverd met 70cm zwart nylon voetkruis en 65mm geremde harde wielen.



Skate synchro zwart, rug in mesh, zitting in Remix RM, armleggers 3D met PU top.

## Modellen

Skate synchro mesh zwart met rug in RR of RY  
Skate synchro mesh wit met rug in RR of RY

Skate synchro zwart met zitting en rug in stof  
Skate synchro wit met zitting en rug in stof

Skate mesh zwart met rug in RR of RY  
Skate mesh wit met rug in RR of RY

Skate zwart met zitting en rug in stof  
Skate wit met zitting en rug in stof

## Stoffering



BN-AL-AB-ME-CH-MF-ST-SY-CS-RM



SC



Scan de prijslijst voor alle opties.

## Skate armleggers



Vaste armleggers zwart (SKATE0N000)  
Vaste armleggers wit (SKATE0B000)



Hoogte verstelbare armleggers step by step zwart (SKATE1N000)  
Hoogte verstelbare armleggers step by step wit (SKATE1B000)



Hoogte en breedte verstelbare armleggers 3D zwart (SKATE3N000)  
Hoogte en breedte verstelbare armleggers 3D wit (SKATE3B000)



## Mesh rug RR in 10 kleuren



## Mesh rug RY in 5 kleuren

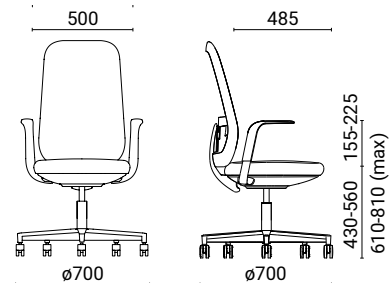

Skate

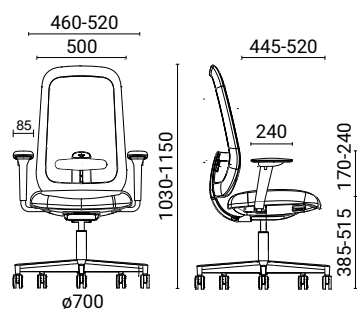

Skate synchro



Nova bureaustoel wit met rug in mesh RY,  
zitting in CH, voetkruis wit en armleggers  
HV wit met zachte PU top

#### Nova

- Leverbaar in zwart of wit kunststof rug- en zittingsupport
- Hoge rug in mesh TT, RR of RY met verstelbare lendensteun
- Zitting van multiplex met vormvast koudschuim (klasse 11M)
- Zitdiepte 7cm verstelbaar voor optimale ondersteuning
- Synchroon mechanisme met 2 hendel-systeem
- Rugleuning anti-panic te fixeren in 4 posities
- Rugcontact gewichtsaafhankelijk instelbaar
- Zwart of wit nylon voetkruis met 50mm geremde wielen
- Voetkruis alu gepolijst met chromen gasveer optioneel
- Diverse armleggers optioneel

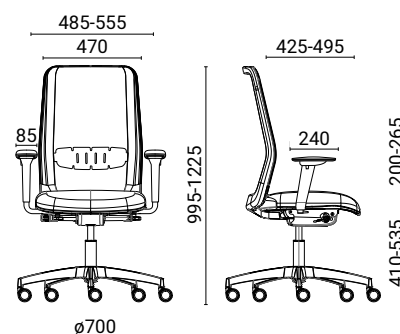



VOORRAAD



4-6  
weken  
LEVERTIJD



GARANTIE



DUURZAAM



CIRCULAIR



MONTAGE



**Modellen**

Nova bureaustoel zwart met rug in mesh TT, RR of RY\*

Nova bureaustoel wit met rug in mesh TT, RR of RY

\* Voorraad in BN01/RR01

**Opties**

Armleggers HV zwart of wit, met zachte PU top (NV1D)

Armleggers 2D zwart of wit, met zachte PU top (NV2D)

Armleggers 4D zwart, met zachte PU top (NV4D)

Aluminium gepolijst voetkruis

Wielen 65mm ongeremd

Wielen 65mm rubber PHD voor harde vloeren

Holle zwarte wielen ongeremd 65mm PHD voor harde vloeren

Holle witte wielen ongeremd 65mm PHD voor harde vloeren

Holle chromen wielen ongeremd 65mm PHD voor harde vloeren

**Stoffering**



BN-AB-ME-CH-ST-MF-MW  
SY-WI



-



-



Our sustainable approach to design

**Mesh rug RR in 10 kleuren**



**Mesh rug RY in 5 kleuren**



**Mesh rug TT**

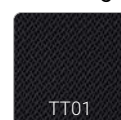

**sitland**



De Mesh-Line van Sitland staat voor optimale kwaliteit!  
Met zijn grote comfort-zitting, forse in hoogte verstelbare  
hoge mesh rug en optimale versteltechniek is dit de  
ideale stoel voor elke werkplek.



**sitland**

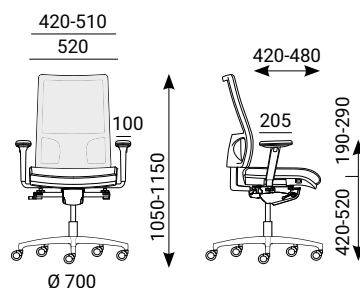



VOORRAAD

4-6  
weken

LEVERTIJD



5

GARANTIE



MONTAGE

- Mesh rug in RR of RY leverbaar
- Zitting met koudschuim en Comfort Air System
- In hoogte verstelbare rugleuning
- Schuifzitting 6cm verstelbaar
- Synchroon mechanisme met 2 hendel-systeem
- Rugleuning anti-panic te fixeren in 5 posities
- Rugcontact gewichtsafhankelijk instelbaar
- Zwart nylon onderstel met zwarte gaslift
- Aluminium gepolijst onderstel met chromen gaslift
- Armleggers optioneel
- 65mm geremde harde wielen

**Model Rug in mesh RR**

Mesh-Line zwart\*

Mesh-Line chroom

\*Voorraad in BN01/RR01

**Opties**

Geremde 65mm PHD wielen voor harde vloeren

Holle zwarte ongeremde 65mm PHD wielen voor harde vloeren

Holle chromen ongeremde 65mm PHD wielen voor harde vloeren

Rug in RY

**Stoffering zitting**AL-BN-AB-ME-CH-RR\*-ST  
RY\*

SC



-

\*RR bij RR rug / RY bij RY rug

**Armleggers**

Hoogte verstelbare armleggers met PU top (TRBREG0101)



Hoogte en breedte verstelbare 2D armleggers met PU top (TRBR031)



Hoogte en breedte verstelbare armleggers 4D met schuifbare en draibare PU top (TRBR051)



Hoogte en breedte verstelbare armleggers 4D met schuifbare en draibare PU top aluminium support (TRBREG021)

**Mesh rug RR in 10 kleuren****Mesh rug RY in 5 kleuren**

Comfort Air System



Wiel 65mm PHD

Hol wiel 65mm met  
zwarte supportHol wiel 65mm met  
chromen support



De Leaf, optimale ergonomie gecombineerd met duurzame materialen in één bureaustoel en voor 98% recyclebaar.

Leaf met haar unieke facet-vormige zitting van 75mm dik koudschuim en Comfort Air luchtkussens. De rugleuning met innovatieve netbespanning heeft een holle ventilerende ruimte en is voorzien van een verstelbare lendensteun.

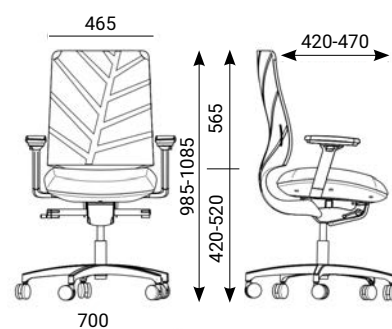

Design by  
Sergio Bellin

**sitland**



Flexibele lendensteun



Ergonomisch



Ventilerend



Flexibele zitdiepte



**Leaf**

- Innovatieve Leaf rug in 2 varianten
- Rugsupport in zwart of witgrijs met verstelbare lendensteun
- Gestoffeerde Comfort Air zitting
- Zitting in unieke facetvorm 75mm dik!
- Schuifzitting met 5cm free-floating
- Synchroon mechanisme
- Rugleuning anti-panic te fixeren in 5 posities
- Rugcontact gewichtsafhankelijk instelbaar
- Zwart, witgrijs óf aluminium gepolijst onderstel
- 65mm geremde wielen
- Armleggers optioneel in diverse uitvoeringen



**Model rug in bladvorm**

Leaf zwart

Leaf witgrijs

**Stoffering zitting**



BN-AB

**Stoffering rug in bladvorm**



BN01/BN04 - AB03/AB51

**Model rug in mesh RR**

Leaf Air zwart

Leaf Air witgrijs

Rug ook leverbaar in mesh RY (Gabriel Rythm) ipv mesh RR

**Stoffering zitting**



BN-AL-AB-ME-CH-RR  
ST-CS-SY-RM

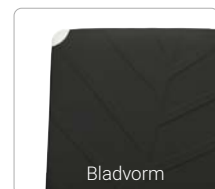

**Opties**

Geremde 65mm PHD wielen voor harde vloeren

Holle zwarte ongeremde 65mm PHD wielen voor harde vloeren

Holle chromen ongeremde 65mm PHD wielen voor harde vloeren

Aluminium gepolijst voetkruis

**Armleggers**



Zwarte hoogte en breedte verstelbare 2D armleggers met PU top (LFBR03)



Zwarte hoogte en breedte verstelbare armleggers 4D met schuifbare en draaibare PU top (LFBR05)



Witgrijze hoogte en breedte verstelbare armleggers 4D met schuifbare en draaibare PU top (LFBR05G)



Zwarte hoogte en breedte verstelbare armleggers 4D met schuifbare en draaibare PU top aluminium gepolijst support (LFBREG04)



Comfort Air System



Wiel 65mm PHD



Hol wiel 65mm met zwarte support



Hol wiel 65mm met chromen support



Team Strike chromo

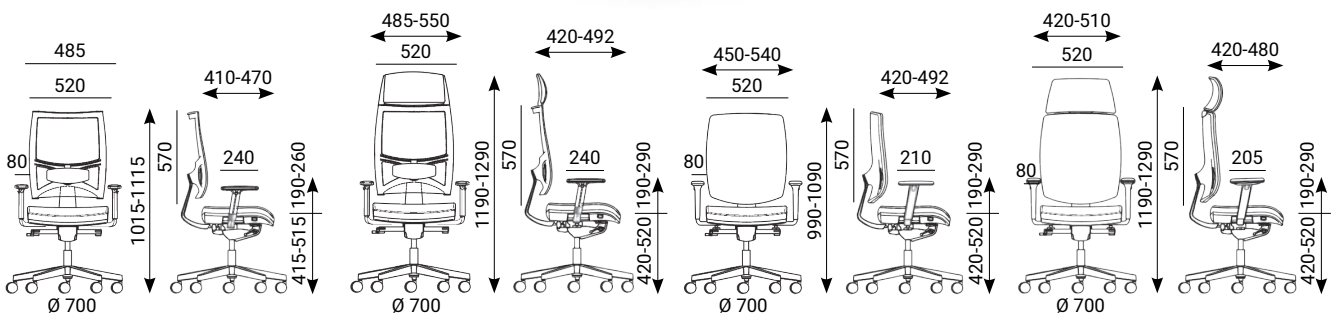

Team Strike Air

Team Strike Air executive

Team Strike

Team Strike executive

### Team Strike

- Bureaustoel met gestoffeerde rug of mesh rug (Air)
- Rugsupport in zwart, lichtgrijs (Air) of chromen uitvoering
- Rug voorzien van hoogte verstelbare lendensteun in PU (Air)
- Leverbaar als executive met gestoffeerde neigbare hoofdsteen of hoogte verstelbare PU-hoofdsteen (Air)
- Comfort Air zitting met vormvast koudschuim
- Schuifzitting 7cm verstelbaar
- Synchroon mechanisme met 2 hendel-systeem
- Rugleuning anti-panic te fixeren in 5 posities
- Rugcontact gewichtsafhankelijk instelbaar
- Onderstel in zwart nylon of aluminium gepolijst (met bijpassende gaslift of lichtgrijs bij Air)
- 50mm geremde wielen voor zachte vloeren



Team Strike Air executive zwart



Team Strike Air lichtgrijs



Team Strike Air chroom

#### Model rug in mesh RF

Team Strike Air zwart

Team Strike Air lichtgrijs

Team Strike Air chroom

Team Strike Air executive zwart

Team Strike Air executive lichtgrijs

Team Strike Air executive chroom

Rugleuning in mesh RR /RP

Rugleuning in mesh RY

#### Model gestoffeerde rug

Team Strike zwart

Team Strike chroom

Team Strike executive zwart

Team Strike executive chroom

#### Stoffering



BN-AL-AB-ME-CH  
MF-ST-SY-RM



NX-SC



SX+NX

#### Armleggers



Hoogte verstelbare armleggers met PU top (TRBREG010)



Hoogte en breedte verstelbare 2D armleggers met PU top (TRBR03)



Hoogte en breedte verstelbare armleggers 4D met schuifbare en draaibare PU top (TRBR05)



Hoogte en breedte verstelbare armleggers 4D lichtgrijs met schuifbare en draaibare PU top (FHBR05G)



Hoogte en breedte verstelbare armleggers 4D met schuifbare en draaibare PU top aluminium support (TRBREG020)



#### Opties

Geremde 65mm PHD wielen voor harde vloeren

Holle zwarte ongeremde 65mm PHD wielen voor harde vloeren

Holle chromen ongeremde 65mm PHD wielen voor harde vloeren

Aluminium gepolijst onderstel



Comfort Air System



Wiel 65mm PHD



Hol wiel 65mm met zwarte support



Hol wiel 65mm met chromen support

sitland



Team Strike Evo, de grote update van de bestseller Team Strike waarbij alle actuele technieken en materialen samenkomen in één.



Team Strike Evo wit met rug in stof ME

Design by  
Zakaria Khalfaoui



Our sustainable approach to design

sitland

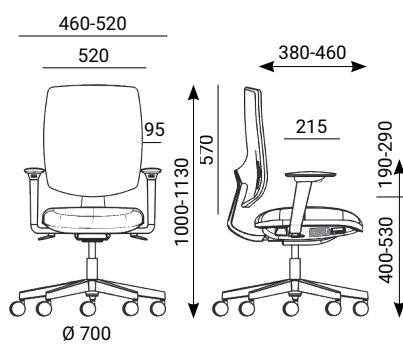

Team Strike Evo

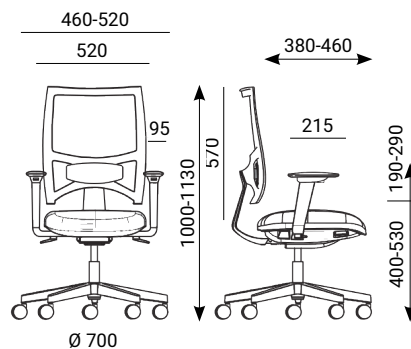

Team Strike Evo Air



Team Strike Evo Air wit met gestoffeerde mesh rug



Team Strike Evo Air zwart met rug in mesh RR



Team Strike Evo zwart met dikke rug

**Team Strike Evo modellen**

Team Strike Evo Air zwart of wit met mesh rug in RF, RR of RY

Team Strike Evo Air zwart of wit met gestoffeerde mesh rug\*

Team Strike Evo zwart met dikke rug gestoffeerd

Team Strike Evo Air executive zwart of wit met mesh rug in RF, RR of RY

Team Strike Evo Air executive zwart of wit met gestoffeerde mesh rug\*

Team Strike Evo executive zwart met dikke rug gestoffeerd

**Stoffering zitting / dikke rug**



BN\*-AL-AB\*-ME\*-CH\*  
MF-SY-CS\*-RM\*



NX-SC



SX

\* gestoffeerde mesh rug



**Team Strike Evo vs Team Strike**

- 1- Rug in mesh of stof
- 2- Rugsupport van gerecycled plastic
- 3- Nieuwe armleggers
- 4- Zitting lijmsloos en eenvoudig vervangbaar
- 5- Nieuw mechaniek weggewerkt in de zittingschaal
- 6- Voetkruis van gerecycled plastic
- 7- Leverbaar in zwart of wit

**Team Strike Evo opties**

Armleggers HV zwart of wit, met zachte PU top (TSEV01)

Armleggers 2D zwart, met zachte PU top (TSEV02)

Armleggers 4D zwart, met zachte PU top (TSEV04)

Aluminium gepolijst voetkruis

Wielen 65mm ongeremd

Wielen 65mm rubber PHD voor harde vloeren

Holle zwarte wielen ongeremd 65mm PHD voor harde vloeren (Starck)

Holle witte wielen ongeremd 65mm PHD voor harde vloeren (Starck)



SCAN  
VOOR  
PRIJSLIJST



Design by  
Baldanzi & Novelli

**sitland**



Spirit manager chromo met  
Spirit design 2D armleggers

#### Spirit

- Spirit rugleuning met het unieke FREEDOM FLEX torsiepunt in het frame
- Gestoffeerde rug met geïntegreerd kledinghaakje
- Rugsupport in matzwart of chromen uitvoering
- In hoogte verstelbare lendensteun
- Spirit zitting met Comfort Air koudschuim
- Schuifzitting 5cm verstelbaar met free float
- 4 graden zithoek-verstelling (optioneel)
- Dynamico synchroon mechanisme met 2 hendel-systeem
- Rugleuning anti-panic te fixeren in 11 posities
- Rugcontact gewichtsaafhankelijk instelbaar
- Spirit voetkruis in zwart nylon of aluminium gepolijst
- 65mm geremde wielen voor zachte vloeren

#### Spirit executive

- Met neigbare gestoffeerde hoofdsteen en zwart of chromen support

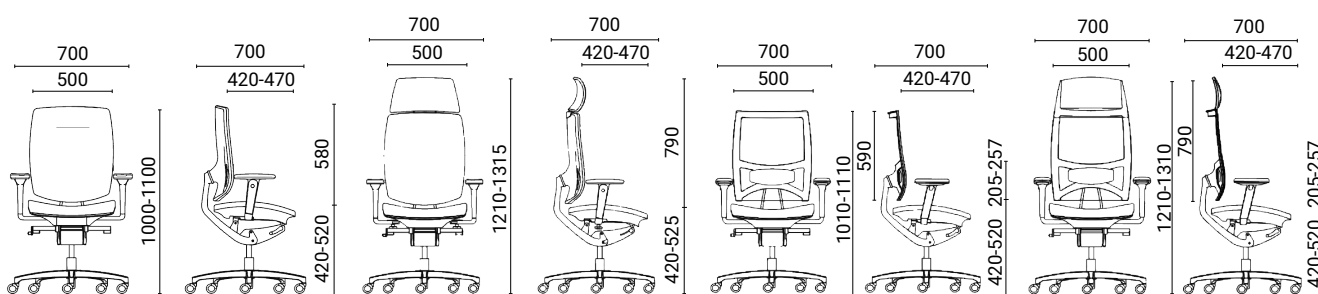

Spirit manager

Spirit executive

Spirit Air manager

Spirit Air executive



Spirit Air manager chroom met Spirit design armleggers



Spirit executive zwart met 4D armleggers

#### Model Spirit

Spirit manager zwart met 4D armleggers zwart

Spirit manager chroom met 4D armleggers chroom

Spirit executive zwart met 4D armleggers zwart

Spirit executive chroom met 4D armleggers chroom

#### Model Spirit Air, rug in mesh RP of RR

Spirit Air manager zwart met 4D armleggers zwart

Spirit Air manager chroom met 4D armleggers chroom

Spirit Air executive zwart met 4D armleggers zwart

Spirit Air executive chroom met 4D armleggers chroom

Spirit Air rug in mesh RY (ipv RP of RR)

#### Stoffering



AL-AB-ME-CH-MF  
ST-CS-SY-RM



NX-SC



SX-PA-TS

#### Opties Spirit en Spirit Air

Spirit design 2D armleggers chroom (ipv 4D armleggers)

Zwart aluminium voetkruis (ipv zwart nylon)

Negatieve zithoek-verstelling 4 graden

Geremde 65mm PHD wielen voor harde vloeren

Holle zwarte ongeremde 65mm PHD wielen voor harde vloeren

Holle chromen ongeremde 65mm PHD wielen voor harde vloeren



Comfort Air System



Wiel 65mm PHD



Hol wiel 65mm met  
zwarte support



Hol wiel 65mm met  
chromen support



Line doet zijn naam eer aan: elegante lijnen afgewisseld met optioneel fraaie stiksels en design armleggers.

#### Line executive advanced & Line manager

- High back met cfk-vrij vormvast koudschuim
- Rondom gestoffeerd (lijnstiksel optioneel)
- Zwart of chromen pyramide voetkruis met 65mm geremde harde wielen
- Mechaniek 1 hendel blokkeerbaar 5 posities (executive & manager) of anti knee-tilting met 4 posities en scharnierpunt aan voorzijde stoel (executive advanced)
- Design armleggers zwart of chroom met zachte PU-inleg

#### Line meeting

- Medium back met cfk-vrij vormvast koudschuim
- Rondom gestoffeerd (lijnstiksel optioneel)
- Pyramide voetkruis verrijdbaar HV 5-teens of draaibaar 4-poots pyramide in zwart of chroom
- Zonder armleggers (optioneel)
- Soft tilting mechanisme (optioneel)

Line P executive advanced  
zwart met holle zwarte wielen

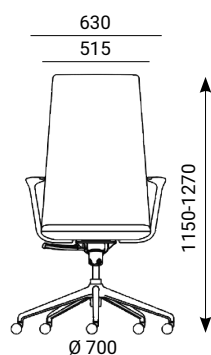

Line executive  
high back

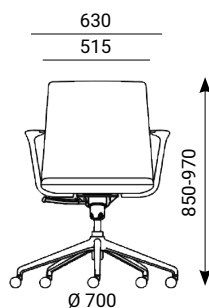

Line manager  
medium back

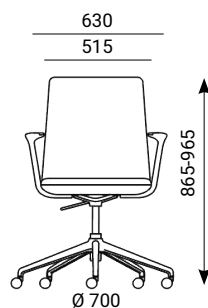

Line meeting  
verrijdbaar HV

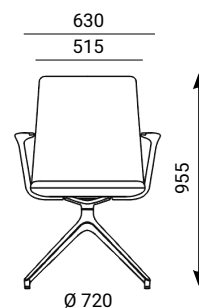

Line meeting  
4-poots





Line L executive chroom met holle chromen wielen



Line L meeting chroom met chromen design armleggers



Line L meeting chroom met holle chromen wielen



Line P meeting zwart met holle zwarte wielen

#### Model Line P (zonder stiksel)

Line executive advanced high back met armleggers

Line executive high back met armleggers

Line manager medium back met armleggers

Line meeting verrijdbaar HV zonder armleggers

Line meeting draaibaar zonder armleggers, pyramide 4-poots chroom

#### Stoffering



ME-CH-MF-CS-SY-RM



NX-SC



SX+NX-PA



#### Opties

Lijn stiksel (Line L)

Soft tilting mechanisme (tbv Line meeting)

Design armleggers voor meeting, in matzwart of chroom

Pyramide 4-poot in matzwart

Geremde 65mm PHD wielen voor harde vloeren

Holle zwarte ongeremde 65mm PHD wielen voor harde vloeren

Holle chromen ongeremde 65mm PHD wielen voor harde vloeren

# sitland



Wiel 65mm PHD



Hol wiel 65mm met zwarte support



Hol wiel 65mm met chromen support



### Classic executive & Classic manager

- Chromen of matzwart frame en armleggers
- Gestoffeerde zitting en rug met horizontale stiksellijnen
- Classic+ speciale stiksel afwerking optioneel
- Neigmechanisme met anti-panic lock
- Rugcontact gewichtsaafhankelijk instelbaar
- Voetkruis alu gepolijst of matzwart
- Geremde 50mm wielen
- Gestoffeerde armopdekjes (optioneel)

### Executive advanced

- Mechanisme anti-knee-tilting (scharnierpunt aan voorzijde van de stoel)
- Gewichtsinstelling met knop aan de onderzijde van het mechanisme
- Rugleuning anti-panic te fixeren in 5 posities

## sitland



Classic executive advanced



Classic manager



Classic visitor

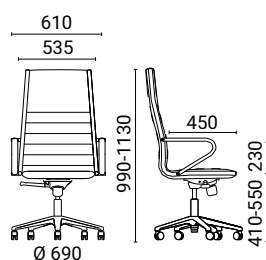

Classic executive

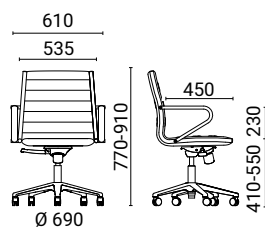

Classic manager

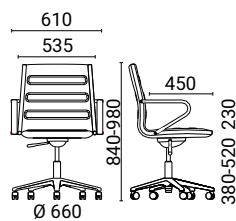

Classic+ meeting HV

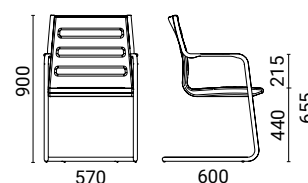

Classic+ visitor



Classic+ meeting HV  
verrijdbaar met armleggers



Classic visitor  
sledeframe



Classic+ meeting  
self return

#### Classic modellen

- Classic executive advanced high back
- Classic executive high back
- Classic manager low back
- Classic meeting HV verrijdbaar met of zonder armleggers
- Classic meeting self return met of zonder armleggers
- Classic visitor sledemodel

#### Stoffering



ME-CH-MF-CS-SY-RM



NX-SC



SX+NX-SX-PA-TS

#### Classic opties

- Gestoffeerde armopdekjes (niet bij visitor sledemodel)
- Classic+ speciale stiksel afwerking
- Geremde 50mm PHD rubberen wielen voor harde vloeren
- Geremde 65mm PHD rubberen wielen voor harde vloeren
- Holle zwarte ongeremde 65mm PHD rubberen wielen voor harde vloeren
- Holle chromen ongeremde 65mm PHD rubberen wielen voor harde vloeren



Classic stiksel



Classic+ stiksel



Wiel 65mm PHD



Hol wiel 65mm met  
zwarte support



Hol wiel 65mm met  
chromen support



Vega-L executive high back chrom, stoffering en armopdekjes in SC, holle chromen wielen

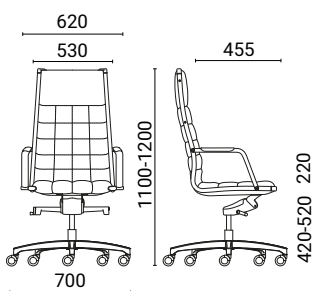

Vega-S executive advanced

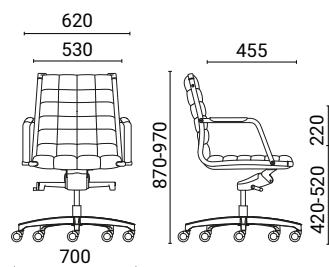

Vega-S manager advanced

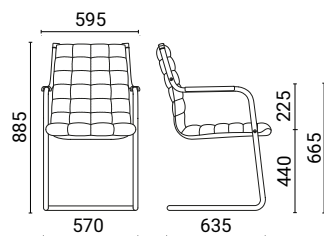

Vega-S visitor

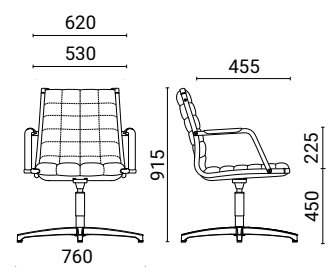

Vega-S meeting self return  
4-teens

Vega, de evolutie van een klassieker met comfort-zitting en voorzien van zeer fraaie stiksel-afwerking. Kies uit de grote vierkanten van de Vega-S of de lijnen van de Vega-L.

**Vega executive high back**

- Chromen of matzwart frame en armleggers
- Zitting en rug in extra dik vormvast koudschuim
- Mechanisme met anti-kneetilting scharnierpunt aan voorzijde van de stoel
- Gewichtsafhankelijk instelbaar met centrale knop onder het mechaniek
- Rugleuning anti-panic blokkeerbaar in 5 posities
- Aluminium gepolijst of matzwart voetkruis met 65mm geremde wielen
- Armopdekjes gestoffeerd (optioneel)



Vega S visitor matzwart

**Vega executive advanced high back**

- Dynamic mechanisme met anti-kneetilting scharnierpunt aan voorzijde van de zitting
- 2 hendel systeem
- Gewichtsinstelling middels slinger in de hendel



Vega L meeting self return chroom met soft tilting

**Vega modellen**

Vega executive advanced high back

Vega executive high back

Vega manager advanced medium back

Vega manager medium back

Vega meeting HV verrijdbaar 5-teens

Vega meeting self return 4-teens

Vega visitor sledemodel

**Stoffering**



MF-CS-SY-RM



NX-SC



SX+NX-SX-PA-TS



**Vega opties**

Gestoffeerde armopdekjes

Soft tilting mechanisme voor Vega meeting

Voetenkruis 4-teens chroom of matzwart met glijdoppen, alleen voor meeting HV

Design by Sergio Bellin

**sitland**

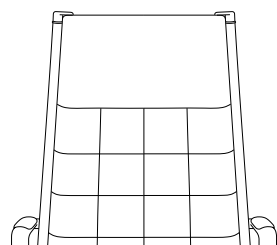

Stiksel Vega S

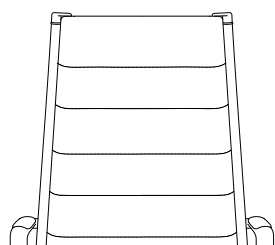

Stiksel Vega L

- Wiel 65mm PHD
- Hol wiel 65mm met zwarte support
- Hol wiel 65mm met chromen support



Vega Hit, directiestoelen met luxe stikselafwerking en exclusieve design armleggers.

**Vega Hit**

- Chrom of matzwart frame met design armleggers
- Zitting en rug in vormvast geïnjecteerd koudschuim voor optimaal comfort
- Stoffering met luxe stikselafwerking in lijnen of blokken (L of S)
- Vega Hit armleggers standaard met zwarte ABS armopdekjes, optioneel gestoffeerd
- Voetkruis in gepolijst of matzwart aluminium met 65mm geremde wielen voor zachte vloeren
- New generation anti knee-tilting mechaniek met scharnierpunt aan voorzijde van de stoel
- Gewichtsafhankelijk instelbaar met slinger in de hendel
- Rugcontact blokkeerbaar in 4 posities



Vega Hit S executive



Vega Hit S manager



Vega Hit S meeting



Vega Hit S manager

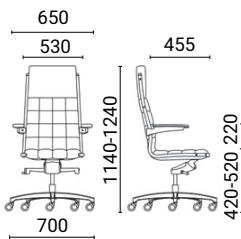

Vega Hit executive

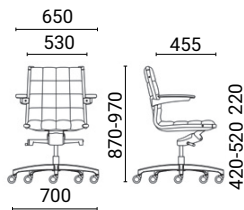

Vega Hit manager

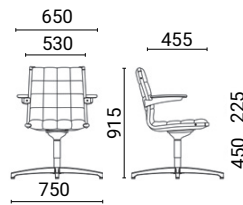

Vega Hit meeting  
self return 4 teens

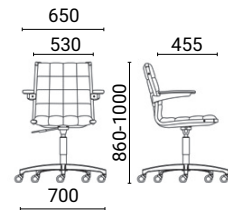

Vega Hit meeting  
HV verrijdbaar

**Vega Hit modellen**

- Vega Hit executive high back
- Vega Hit manager medium back
- Vega Hit meeting HV verrijdbaar
- Vega Hit meeting self return 4-teens

**Vega Hit opties**

- Gestoffeerde armopdekjes
- Soft tilting 3D mechaniek bij meeting modellen
- Ongeremde wielen 65mm
- Rubberen PHD wielen 65mm geremd
- Holle zwarte PHD wielen 65mm ongeremd
- Holle chromen PHD wielen 65mm ongeremd

**Stoffering**

- MF-CS-SY-RM
- NX-SC
- SX+NX-SX-PA  
TS-TU

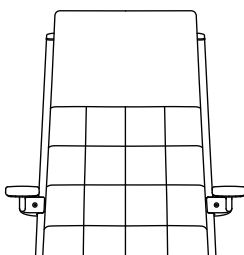

Stiksel Vega Hit S

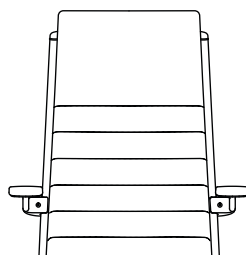

Stiksel Vega Hit L

- Wiel 65mm PHD
- Hol wiel 65mm met  
zwarte support
- Hol wiel 65mm met  
chromen support



#### Sit-it high back of medium back

- Frame en armleggers in chroom
- Plat design aluminium gepolijst voetkruis of extra verchromd (meerprijs)
- Neigmechaniek anti-knee-tilting en blokkeerbaar in 4 posities
- Inclusief chromen armleuningen
- Zitting en rug in diverse densiteiten foam voor optimaal comfort
- Geremde wielen 65mm voor zachte vloeren
- De rug-achterzijde is altijd in zwart of wit.

#### Sit-it meeting

- Frame en armleggers in chroom
- Plat design aluminium gepolijst 4-spaaks voetkruis of extra verchromd (meerprijs)
- Sit-it armleggers in chroom
- Hoogte verstelbaar of self-return

Designed by  
Fiorenzo Dorigo

**sitland**





Sit-it manager medium back



Sit-it meeting self return

**Model**

- Sit-it executive high back
- Sit-it manager medium back
- Sit-it meeting HV
- Sit-it meeting self return

**Stoffering**



-



SC



SX-PA-TS



**Opties**

- Gestoffeerde armopdekjes
- Extra verchromd voetkruis 4- en 5-teens
- Geremde 65mm PHD wielen voor harde vloeren
- Holle zwarte ongeremde 65mm PHD wielen voor harde vloeren
- Holle chromen ongeremde 65mm PHD wielen voor harde vloeren

**Bij iedere stofferingkeuze staat de kleur van de achterzijde vast:**

**Wit      Zwart**

- SC01    SC17/SC18
- SX03    SX01/SX02/SX07/SX11
- PA02    PA04/PA08/PA09/PA11
- TS15    TS01/TS13/TS24

Andere combinaties op aanvraag

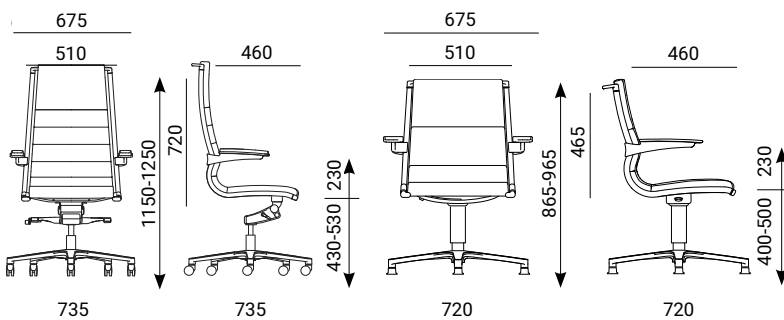

Sit-it executive high back

Sit-it meeting HV



Wiel 65mm PHD

Hol wiel 65mm met zwarte support

Hol wiel 65mm met chromen support



**sitland**

**Of Course executive high back**

- Optimaal comfort door verschillende densiteiten vormvast koudschuim
- Dynamico synchroon mechanisme anti-panic te fixeren in 4 posities
- Gewichtsafhankelijk instelbaar
- Rondom gestoffeerd
- Aluminium gepolijst of optioneel extra verchromd plat design voetkruis
- 65mm ongeremde wielen voor zachte vloeren



Of Course meeting 4-teens self-return

**Of Course modellen**

Of Course executive high back

Of Course manager medium back

Of Course meeting 5-teens draaibaar

Of Course meeting 5-teens HV

Of Course meeting 4-teens draaibaar

Of Course meeting 4-teens self-return

Of Course meeting 4-teens HV

Of Course visitor sledeframe

**Of Course opties**

Extra verchromd voetkruis 4- of 5-teens

Rubberen PHD wielen 65mm geremd

Holle zwarte PHD wielen 65mm ongeremd

Holle chromen PHD wielen 65mm ongeremd

**Stoffering**



CS-SY-RM



SC



SX+NX-SX-PA  
TS-TU



Of Course visitor sledeframe

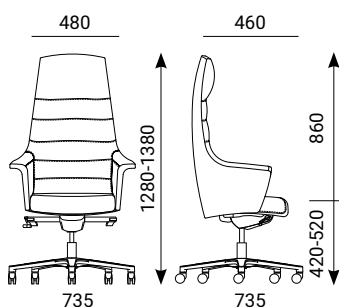

Executive high back

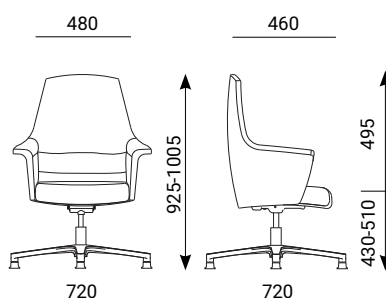

Meeting 4-teens draaibaar





Conferentie- en vergaderstoelen zijn er natuurlijk in allerlei vormen en maten.

Wilt u goed en comfortabel zitten voor een intensieve meeting, kies dan voor een stoel met een comfortabel en flexibel sledeframe. Even een kort overleg, dan zijn de vele fraaie modellen met kuipzit en 4-poots of pyramide poten mogelijk.

Heeft u echter stoelen nodig voor zeer verschillende doeleinden, dat kan het best met een stoel waar u keuze heeft in diverse pootjes. Hoe dan ook, voor elke wens bieden wij u een passende oplossing.

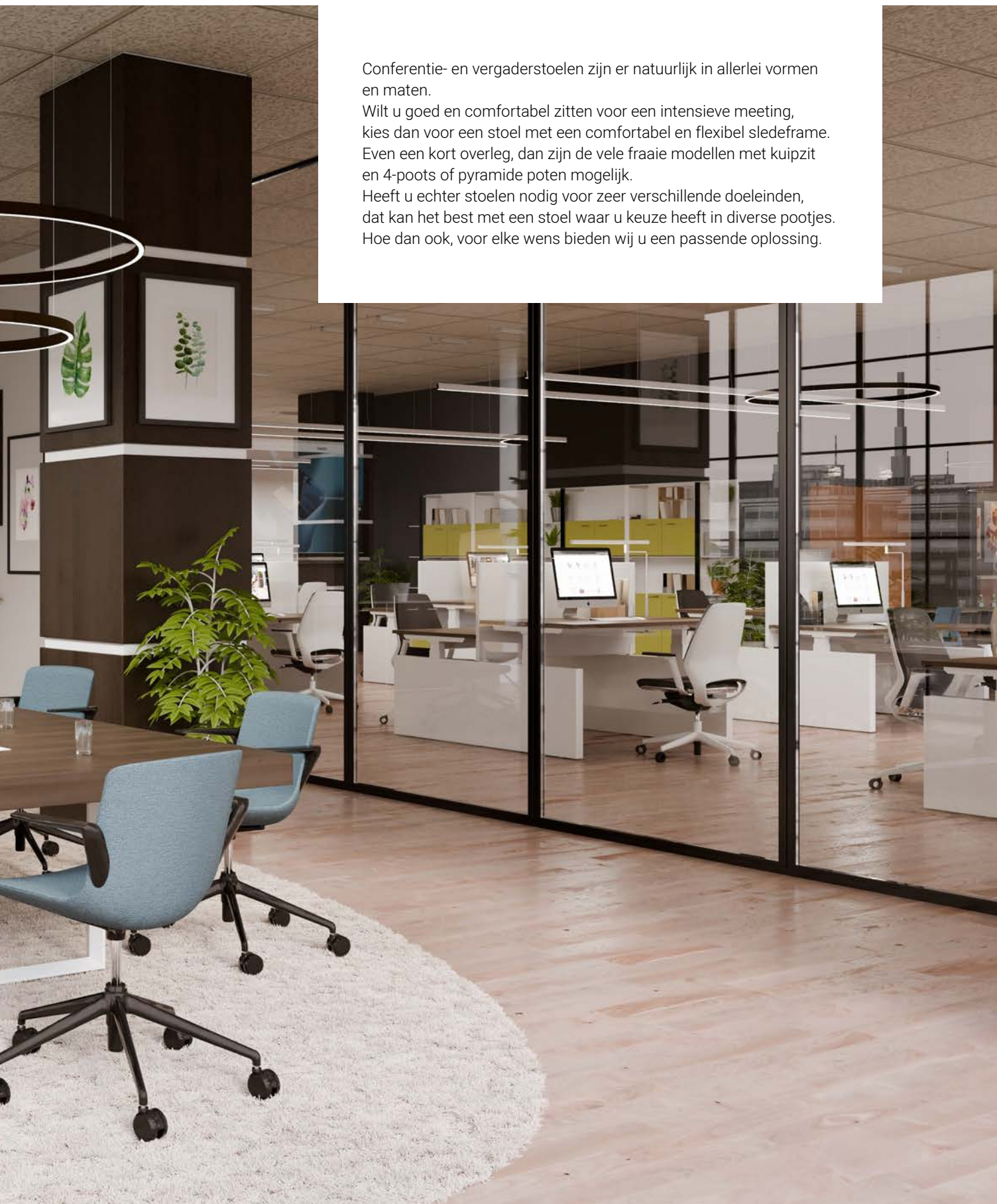

T45 meeting vergadertafel met Milos meeting vergaderstoel



Flap, ontworpen door Eurolinea Studio. Uitgevoerd in technopolymeer, dus 100% recyclebaar. Flap onderscheidt zich door haar grote zitcomfort en stabiliteit, en is door een gepatenteerd vouwsysteem zeer eenvoudig te stapelen. Geschikt voor binnen en buiten, de ideale stoel voor elke omgeving.



Muurbeugel  
zwart of wit tbv  
2x klapstoel



Gaber®

#### Flap modellen

Flap klapstoel (per 2 stuks)

#### Opties

Flap trolley met zwenkwieën metaal zwart

Flap muurbeugel 23bx16dx7h kunststof zwart of wit

Flap koppeling kunststof wit

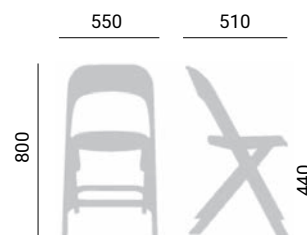

Flap klapstoel leverbaar in 10 kleuren





Dream klapstoel, ontworpen door Frédéric Boonen, is gemaakt van versterkt polypropyleen, onverwoestbaar en tijdloos. Uit voorraad leverbaar in 6 kleuren, geschikt voor binnen en buiten.



Dream klapstoel leverbaar in 6 kleuren

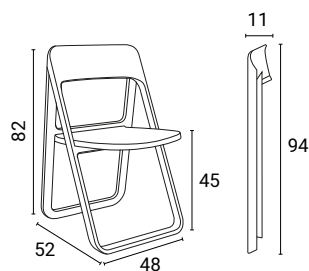

Dream

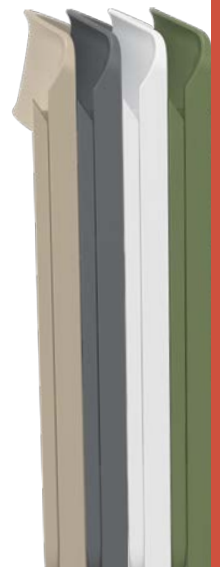







Stapelbare stoel Artesia, met haar ranke en elegante uitstraling verrassend stevig en comfortabel. Goede zithouding en uitermate geschikt voor vele flexibele toepassingen.

Leverbaar in 7 kleuren kunststof kuip (Greenguard 100% recyclebaar) met bijpassend metalen frame in duurzaam poedercoat. Het armleggerframe is leverbaar in zwart of chroom met de kunststof armleggers in dezelfde kleur als de zitting.

### Artesia S zonder armleggers



Frame in zwart, wit of chroom  
Frame in kleur

### Artesia barkruk



Frame in zwart, wit of chroom  
Frame in kleur

### Artesia SS met armleggers



Frame in zwart of chroom

### Optie Artesia S



Schrijftablet met chromen support en top in kunststof (rechts- of linkshandig)

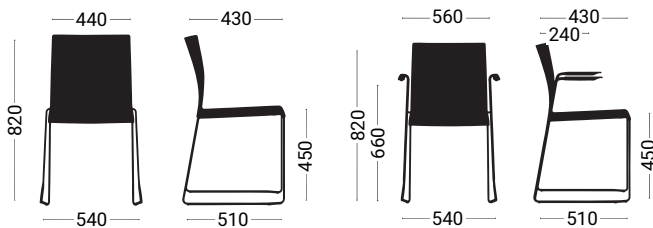

### Optie kussen (per 4 stuks te bestellen)



Artesia kussen klein in stof (38x40cm)



Artesia kussen groot in stof (44x43cm)

### Stoffering kussen



K-B-DK



E



-



### Trolley



Artesia trolley zwart metaal met grote zwenkwielen en handige beugel, geschikt voor max 50 stoelen (hoogte 210cm).



### Artesia kunststof kuip leverbaar in 7 kleuren



### Artesia S leverbaar in 8 framekleuren Artesia SS leverbaar in chroom of zwart

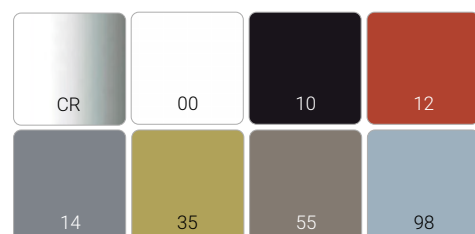



Design by  
Studio Favaretto

Nuta en Nuta Light van Gaber, ontworpen met een elegante en tijdloos klassieke uitstraling.

Nuta in 100% recyclebaar TP (Greenguard) en Nuta Light met metalen 4-pootsframe voorzien van comfortabele zitting en rug in stof.

#### Nuta kunststof modellen



Nuta zonder armleggers



Nuta B met armleggers



Nuta Stool 68 en 78h

Nuta zitkussens los (vanaf 4 stuks)  
Nuta rugkussens los (vanaf 4 stuks)

#### Stoffering Nuta kussens



K-MG-SX-B-DK



E



-



Nuta met kussens

#### Nuta Light modellen



Nuta Light zonder armleggers  
(vanaf 4 stuks)



Nuta Light B met armleggers  
(vanaf 4 stuks)



Nuta Light Stool 67 en 77h  
(vanaf 4 stuks)

#### Stoffering Nuta light



K-MG-S



-



-



Nuta

#### Nuta leverbaar in 8 kleuren kunststof



#### Metalen framekleuren Nuta Light

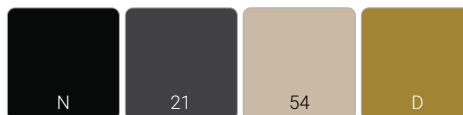

Gaber®



Nuta Light



Design by  
Forsix

De unieke vorm van de rug en de strakke designlijnen maken Jubel een opvallende verschijning. Leverbaar in een aantrekkelijke reeks kuip-kleuren en diverse onderstellen.

## Jubel modellen



Jubel NA 4-poots metaal  
Jubel TB 4-poots metaal met armleggers



Jubel S ringpoot  
Jubel SS ringpoot met armleggers



Jubel BL 4-poots hout



Jubel 5R verrijdbaar  
Jubel 5R-BR verrijdbaar met armleggers



Jubel L pyramidepoot  
Jubel L-BR pyramidepoot met armleggers



Jubel IV kunststof 4-poots  
Jubel IV kunststof 4-poots met armleggers

Jubel trolley is in 3 modellen leverbaar (zie prijslijst)



Jubel ST66 barkruk ringpoot  
Jubel ST76 barkruk ringpoot



Jubel BST66 barkruk gestoffeerd  
Jubel BST76 barkruk gestoffeerd

Jubel zitkussen los (vanaf 4 stuks)

## Stoffering Jubel kussen of kuip



K-DK-(kussen +B)



E



-



Jubel IV

Jubel leverbaar in 6 kleuren





Design by  
Stefano Sandona

Met Kanvas kan elke wens worden ingevuld.  
Strakke vormgeving en leverbaar in een veelvoud aan uitvoeringen.  
Diverse modellen frames met een comfortabele kunststof kuip,  
optioneel front of volledig gestoffeerd leverbaar.

#### Kanvas modellen



Kanvas NA 4-poots metaal



Kanvas TB 4-poots metaal met armleggers



Kanvas S ringpoot dun



Kanvas ST ringpoot buisframe



Kanvas Z



Kanvas TC spinpoot



Kanvas T5R verrijdbaar  
Kanvas T5R-BR verrijdbaar met armleggers



Kanvas BL 4-poots hout

Kanvas trolley is in 2 modellen leverbaar (zie prijslijst)



Kanvas ST66 barkruk ringpoot buisframe  
Kanvas ST76 barkruk ringpoot buisframe

Kanvas zitkussen los (vanaf 4 stuks)

#### Stoffering



K-B-DK



E



-



Kanvas NA

Kanvas kuip leverbaar in 12 kleuren

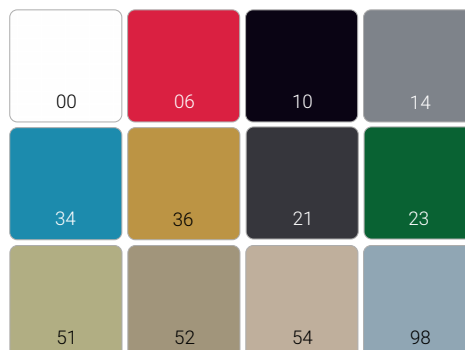



Design by  
Stefano Sandona

De strak vormgegeven en stevige Akami heeft een geperforeerde rugleuning met handige greep. Akami is in diverse modellen leverbaar met de kuip in 5 kunststofkleuren of met vormvast koudschuim en rondom gestoffeerd.

## Akami modellen



Akami NA 4-poots metaal



Akami TB 4-poots metaal met armleggers



Akami S ringpoot dun



Akami SS ringpoot met armleggers



Akami BL 4-poots hout



Akami T5R verrijdbaar  
Akami T5R-BR verrijdbaar met armleggers



Akami U pyramidepoot  
Akami U BR pyramidepoot met armleggers



Akami UR pyramidepoot verrijdbaar  
Akami U BR pyramidepoot verrijdbaar met armleggers

Akami trolley is in 2 modellen leverbaar (zie prijslijst)



Akami ST66 barkruk ringpoot buisframe  
Akami ST76 barkruk ringpoot buisframe

Akami zitkussen los (vanaf 4 stuks)

## Stoffering



K-B-DK



-



-



Akami TB

Akami kuip leverbaar in 5 kleuren

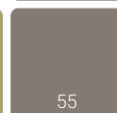
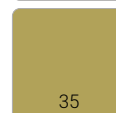
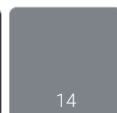
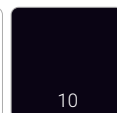
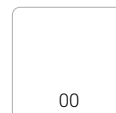



Design by  
Alessandro Busana

Fraaie kuipstoel met een ruime keuze aan praktische onderstellen. Basket is leverbaar met kunststof kuip in 6 kleuren of volledig gestoffeerd met vormvast koudschuim in diverse stoffen.

#### Basket modellen



Basket NA 4-poots metaal



Basket BP 4-poots kunststof



Basket BL 4-poots hout



Basket CTL sledeframe



Basket ST ringpoot buisframe



Basket U pyramidepoot



Basket UR pyramidepoot verrijdbaar



Basket PL pyramidepoot hout

#### Stoffering



K-B-S-DK



E



-



Basket U



Basket kuip leverbaar in 6 kleuren

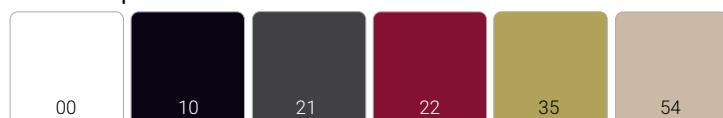

Gaber®



LEVERTIJD



GARANTIE



CIRCULAIR



MONTAGE



De Dame van Gaber, elegante kuipstoel ontworpen door Forsix en leverbaar in 8 kleuren met diverse onderstellen.

Dame is standaard voorzien van een comfortabel gestoffeerd zitkussen en leverbaar met kunststof kuip of kuip met vormvast koudschuim gestoffeerd (vanaf 4 stuks).

Design by  
Forsix

Gaber®

## Dame modellen



Dame NA 4-poots metaal



Dame BP 4-poots kunststof



Dame BL 4-poots hout



Dame CTL sledeframe



Dame ST ringpoot buisframe



Dame R draaibare ronde voet



Dame U pyramidepoot



Dame UR pyramidepoot verrijdbaar



Dame PL pyramidepoot hout



Dame S 68 barkruk ringpoot buisframe

## Stoffering



K-B-S-DK-SX-MG



E



P



Dame BP

## Dame kuip leverbaar in 8 kleuren





City kuipstoelen, comfortabel en veelzijdig. Kies het ideale onderstel en het kuipzitzje in de gewenste stofkleur, voor elke ruimte de juiste oplossing.

### City modellen



City 4-poots metaal



City ringpoot metaal



City 4-poots hout



City pyramide poot (white, silver en shadow grey)



City 4-poots design frame (Déco) metaal (shadow grey, gold, bronze en corten)



City sledeframe



City spinpoot verrijdbaar incl. 65mm zwarte wielen tbv zachte vloeren (chromm, white, silver en shadow grey)

### Kleuren hout onderstel



Natural Varnished



Walnut Varnished

### Kleuren metaal onderstel

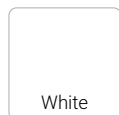

White

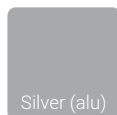

Silver (alu)



Chrome



Shadow grey

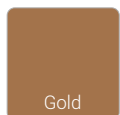

Gold

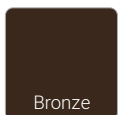

Bronze



Corten

### Stoffering



B01 - C01 - C05 - D02 - D03  
E01 - D04 - E02 - E03 - E04  
I01 - I02 - M01 - M02 - M03



B03 - D06



P01



SCAN  
VOOR  
PRIJSLIJST

### Opties

Set viltgeleiders tbv 4-poots metaal

Set viltgeleiders tbv 4-poots hout

Set viltjes tbv pyramide poot

Set viltgeleiders tbv 4-poots design frame (Déco) metaal

Set 65mm PHD wielen zwart tbv harde vloeren

Set 65mm PHD wielen wit of zilver tbv harde vloeren

Set 65mm PHD holle wielen wit of zilver tbv harde vloeren

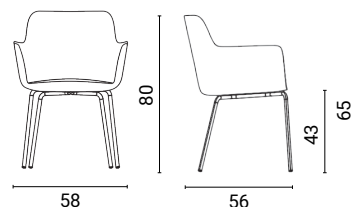



City Déco geeft net dat beetje extra. Comfortabel en ruim gestoffeerd waardoor de City Déco die huiselijke look krijgt met nonchalante vouwen in de ruime keuze aan stofferingen.



## City Déco modellen



City Déco 4-poots metaal



City Déco ringpoot metaal



City Déco 4-poots hout



City Déco 4-poots design frame (Déco) metaal  
(shadow grey, gold, bronze en corten)



City Déco sledeframe

## Opties

Set viltgeleiders tbv 4-poots metaal

Set viltgeleiders tbv 4-poots hout

Set viltgeleiders tbv 4-poots design frame (Déco) metaal

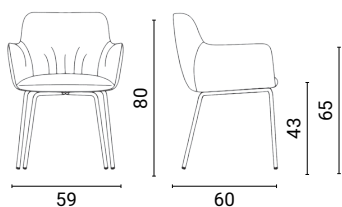

## Stoffering



D02 - D03 - E01 - D04  
E02 - E03 - E04 - I01



-



-



SCAN  
VOOR  
PRIJSLIJST

Design by  
Edi & Paolo Ciani



Quadrifoglio Group



City Déco 4-poots hout



Cove, één grote familie!

Slim en comfortabel kuipmodel in combinatie met verschillende afwerkingen en onderstellen maken de Cove ideaal voor verschillende functies en ruimtes.

Facilitair pluspunt: hang de Cove stoel met de armleggers aan uw tafelblad om de vloer eronder goed te kunnen reinigen.

Cove is leverbaar in 9 kleuren duurzaam PP kunststof met optionele zitkussens of in rondom gestoffeerde kuip met vormvast geïnjecteerd koudschuim.

**Cove modellen**



Cove 4-poots chrome, silver, white of shadow grey (PP kuip stapelbaar t/m 4 stoelen)



Cove ring chrome, silver, white of shadow grey (PP kuip stapelbaar t/m 4 stoelen)



Cove 4-poots houten frame in oak of walnut



Cove HV verrijdbaar in silver, white of shadow grey



Cove pyramidepoot draaibaar in silver, white of shadow grey



Cove barkruk 4-poots H65 of H75 in chrome



Cove barkruk HV (53-78h) met ronde voet en voetsteun in chrome



Cove kruk HV (58-84h) voetkruis met voetring in silver of white



Cove bankje 2, 3 of 4-zits in diverse uitvoeringen leverbaar, frame silver

**Stoffering**



B01-C01-C05-D02  
D03-E01



B03



P01



Cove zitkussen groot

Cove zitkussen gestoffeerd klein  
Cove zitkussen gestoffeerd groot

**Cove kuip in 9 kleuren polypropyleen**



**Kleuren metaal**

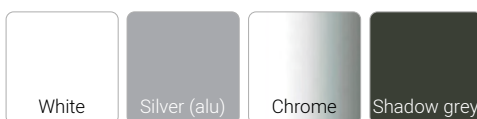

**Kleuren hout**





De Soul met body uit één stuk combineert een elegante vormgeving met slim verborgen techniek. Soul is in hoogte verstelbaar en stelt zichzelf in naar uw gewicht.

Leverbaar als Soul Air met ademende mesh rug en Soul Tecno met de rug uitgevoerd in stof.



Soul Tecno

**Soul Air / Soul Tecno**

- Polyamide frame uit 1 stuk met of zonder armleggers
- Frame in zwart of lichtgrijs ral 7047
- Hoogte verstelbaar met hendel in frame verwerkt
- Neigemechaniek gewicht onafhankelijk
- Kuip Soul Air in mesh of Soul Tecno thermisch gevormd met streeppatroon

Design by  
Inger Mosholt Nielsen

**sitland**



Soul Air lichtgrijs met  
pyramidepoot alu gepolijst



Soul Air met  
pyramidepoot zwart

**Soul modellen**

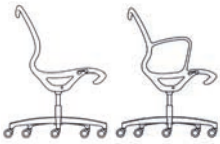

Soul Air of Tecno zonder armleggers zwart  
verrijdbaar 5-teens nylon

Soul Air of Tecno met armleggers zwart of  
lichtgrijs verrijdbaar 5-teens nylon

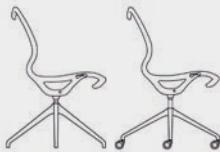

Soul Air of Tecno zonder armleggers zwart  
pyramidepoot 4-teens alu

Soul Air of Tecno zonder armleggers zwart  
pyramidepoot 4-teens alu verrijdbaar

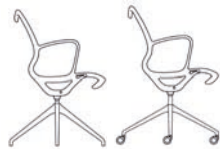

Soul Air of Tecno met armleggers zwart of  
lichtgrijs pyramidepoot 4-teens alu

Soul Air of Tecno met armleggers zwart of  
lichtgrijs pyramidepoot 4-teens alu verrijdbaar

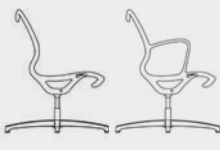

Soul Air of Tecno zonder armleggers zwart  
4-teens alu gepolijst

Soul Air of Tecno met armleggers zwart of  
lichtgrijs 4-teens alu gepolijst



Soul Air verrijdbaar met 5-teens  
pyramidepoot zwart of alu gepolijst  
met holle wielen Starck

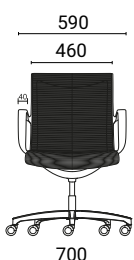

Soul Air

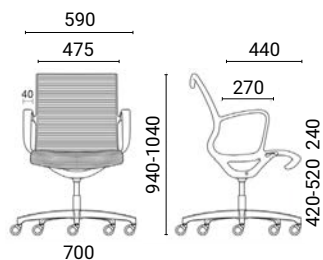

Soul Tecno

**Stoffering**



Mesh RR-RY-IR



Tecno ME01  
ME02-ME03  
ME09



**RR mesh (Gabriel Runner) in 10 kleuren**



**RY mesh (Gabriel Rhythm) 5 kleuren**



**IR mesh (Fidivi Iron)**



**Tecno stoffering in  
ME (Gabriel Medley)**

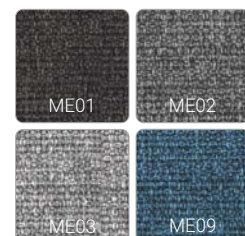



**sitland**



Join meeting 4-poots verrijdbaar zwart



Join meeting 4-poots wit



Join HV 5-teens verrijdbaar zwart



Join slede wit

Join is breed inzetbaar en leverbaar in diverse uitvoeringen. Met zijn hoge rug en geïntegreerde armleggers is Join er als zwarte of witte variant.

Kies voor de verrijdbare 5-poots versie met hoogte verstelling, een stijlvolle meeting pyramide voet of het comfortabele stapelbaar sledeframe (max 3 stuks).

De rug kan naar wens gestoffeerd of in mesh TT, RF, RR of RY worden gekozen.



### Join modellen

Join slede zwart of wit stapelbaar\*

Join meeting 4-poots zwart of wit

Join meeting 4-poots verrijdbaar zwart of wit

Join HV 5-teens verrijdbaar zwart of wit

\* Join slede zwart in BN01/RR01 op voorraad

### Stoffering zitting



BN-AL-AB-ME-CH-ST  
MF/MW-CS-SY-WI



-



-

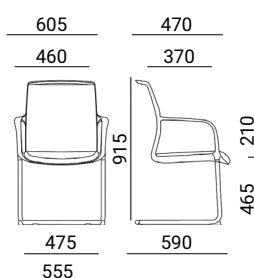

Join slede

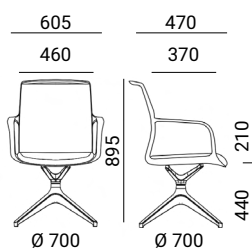

Join meeting 4-poots

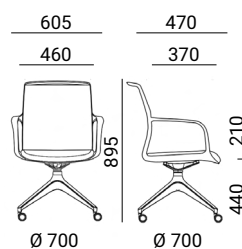

Join meeting 4-poots verrijdbaar

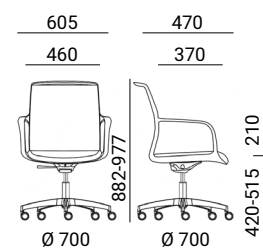

Join HV 5-teens verrijdbaar



Comfortabele gestoffeerde sledestoel voor ieder interieur. Het fraaie buisframe is leverbaar in matzwart of chroom met koudschuim Comfort Air zitting en rug in medium of high back versie. Optioneel te voorzien van zwarte PU armopdekjes en viltgeleiders voor harde vloeren. Stoffering in duo-toon is tevens mogelijk met een meerpijs van 10%.







VOORRAAD



4-6  
weken

LEVERTIJD



5

GARANTIE



MONTAGE



### Uni modellen

Uni medium back matzwart frame

Uni medium back chroom frame

Uni high back matzwart frame

Uni high back chroom frame

Uni in de 4 uitvoeringen in BN01 op voorraad

### Stoffering



BN-AL-AB-ME-CH-MF  
MW-ST-CS-SY-WI



ECO

NX-SC



SX+NX-SX-PA-TS

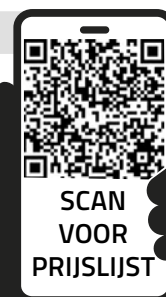

SCAN  
VOOR  
PRIJSLIJST

### Opties

PU armopdekjes zwart

Viltgeleiders tbv harde vloeren

In duo stoffering leverbaar (veelvoud van 2 stuks per stofkleur)

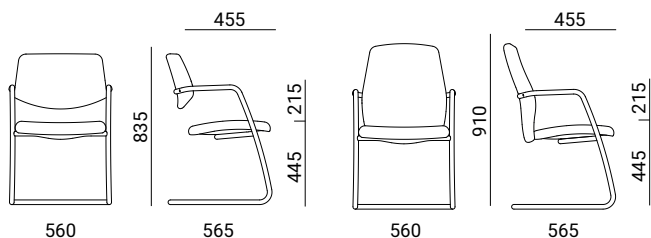

Uni medium back

Uni high back

sitland



Comfort Air System



De comfortabele vergaderstoel met stevig metalen frame en de fraaie kenmerkende verstekhoeken bij de armleuningen. Rug en zitting zijn uitgevoerd in CFK-vrij koudschuim met Comfort Air techniek en fraai gestikte zijpanden.

Kies uw ideale model in slede, 4-teens of verrijdbaar en diverse stof- en ledersoorten. Ook leverbaar in duo-toon en standaard voorzien van conische armleggers met standaard PU opdekjes.



PassePartout medium back matzwart frame in duo-toon ME13+ME11



PassePartout high back chrom frame



PassePartout meeting 4-teens

**PassePartout modellen**

PassePartout sledeframe medium back matzwart of chroom

PassePartout sledeframe highback matzwart of chroom

PassePartout meeting medium back HV verrijdbaar 5-teens matzwart of chroom

PassePartout meeting high back HV verrijdbaar 5-teens matzwart of chroom

PassePartout meeting medium back self return 4-teens chroom

PassePartout meeting high back self return 4-teens chroom

**Stoffering**



BN-AL-AB-ME-CH-MW  
MF-CS-ST-SY-WI



NX-SC



SX+NX-SX



**sitland**



Comfort Air System

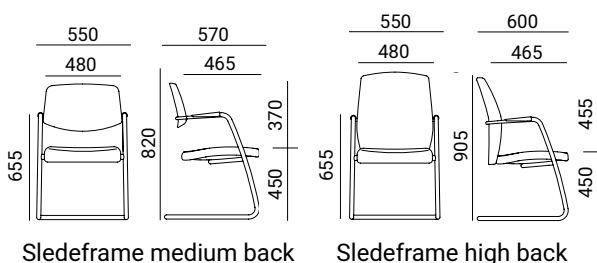

Sledeframe medium back

Sledeframe high back

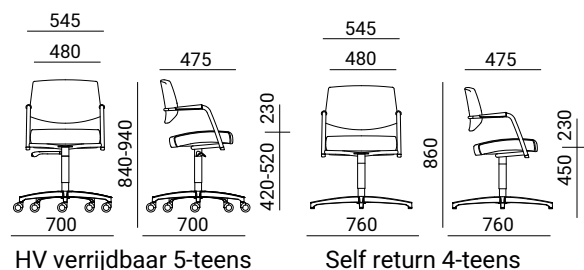

HV verrijdbaar 5-teens

Self return 4-teens



Met zijn bewegende rugleuning zorgt PK voor echt optimaal zitcomfort. Leverbaar als sledeframe of als hoogte verstelbare 4- of 5-teens variant. Met de conisch gevormde armleggers krijgt PK een eigentijdse look. Kies voor diverse kleuren frame en combineer die met zwarte of lichtgrijze kunststof delen. De rugleuning en zitting zijn er in 4 soorten mesh en de zitting kan desgewenst ook worden gestoffeerd.



PK met bewegende rugleuning



Design by  
Sergio Bellin



**PK model rug en zitting in mesh**

PK slede zwart, lichtgrijs of chroom

PK 4-teens meeting HV zwart of chroom

PK 5-teens verrijdbaar HV zwart of chroom

**PK model rug in mesh en zitting gestoffeerd**

PK slede zwart, lichtgrijs of chroom

PK 4-teens meeting HV zwart of chroom

PK 5-teens verrijdbaar HV zwart of chroom

**Opties**

Viltgeleiders (slede)

Kunststof delen in lichtgrijs

**Stoffering**



BN-AL-AB-ME-CH-RR-RY  
MW-MF-ST-CS-SY-WI  
(mesh: RF-RP-RR-RY)



SC



-



sitland



Comfort Air System

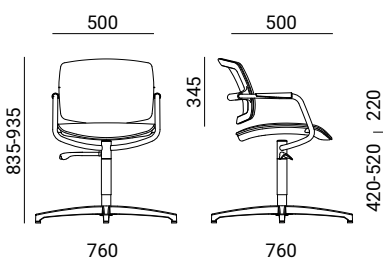

PK 4-teens

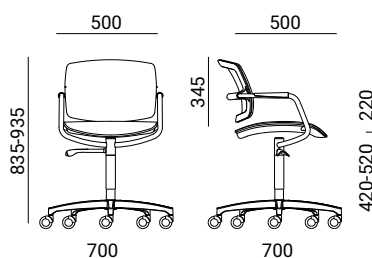

PK 5-teens verrijdbaar

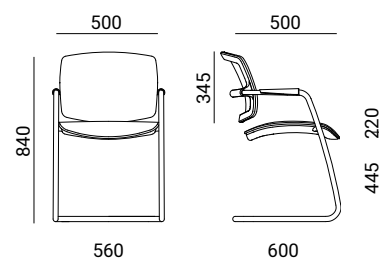

PK slede



De herkenbare Classic vergaderstoel met haar exclusief vormgegeven sledeframe in matzwart of chroom. Het fraaie armleggerframe draagt een rondom gestoffeerde kuip die voorzien is van comfortabel koudschuim en fraaie stikselafwerking in lijnen of retro bij de Classic+ versie. De Classic Visitor van het Italiaanse Sitland is in diverse stof- en leersoorten naar uw eigen wensen leverbaar.



#### Classic visitor model

Classic visitor met matzwart of chroom frame

Classic+ visitor met matzwart of chroom frame

#### Stoffering



ME-CH-MF-CS-SY-RM



NX-SC



SX+NX-PA-TS

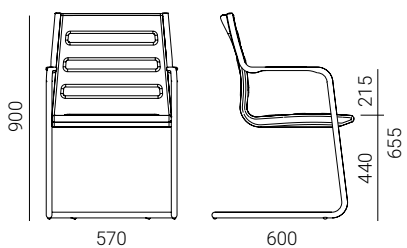

Classic stiksel

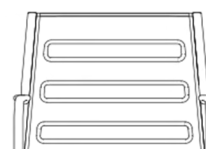

Classic+ stiksel



Vega visitor, ontworpen door Sergio Bellin, de evolutie van een klassieker. Extra comfortabele zitting van vormvast koudschuim met fraaie stikselaafwerking. Kies uit de grote vierkanten van Vega-S of de lijnen van de Vega-L. Standaard voorzien van PU armopdekjes, optioneel gestoffeerd.



### Vega visitor model

Vega-S visitor sledeframe in matzwart of chroom

Vega-L visitor sledeframe in matzwart of chroom

Optie gestoffeerde armopdekjes

### Stoffering



MF-CS-SY-RM



NX-SC



SX+NX-SX-PA-TS

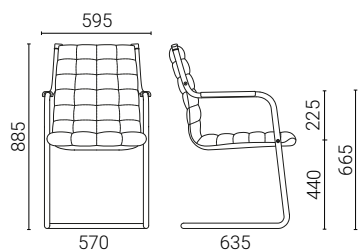

Vega-S visitor

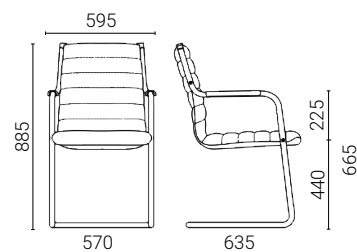

Vega-L visitor



Vega, ontworpen door Sergio Bellin, met extra comfortabele zitting van vormvast koudschuim. Kies uit de fraaie stikselaafwerking met grote vierkanten van de Vega-S of de lijnen van de Vega-L. Vega Hit heeft naast een chroom of matzwart frame de herkenbare design armleggers. Standaard zijn de Vega en Vega Hit voorzien van krasvaste PU armopdekjes, optioneel gestoffeerd leverbaar.







Vega L meeting self return 4-teens



Vega Hit S meeting self return 4-teens

**Vega en Vega Hit meeting**

- Matzwart of chromen frame en armleggers
- Voetkruis in matzwart of gepolijst aluminium
- Armleggers standaard voorzien van zwarte ABS opdekjes

**Vega en Vega Hit modellen**

- Vega meeting HV verrijdbaar 5-teens
- Vega Hit meeting HV verrijdbaar 5-teens
- Vega meeting self return 4-teens
- Vega Hit meeting self return 4-teens

**Stoffering**

- MF-CS-SY-RM
- NX-SC
- SX+NX-SX-PA-TS-TU



**Vega en Vega Hit meeting opties**

- Gestoffeerde armopdekjes
- Soft tilting 3D mechaniek
- Ongeremde wielen 65mm
- Rubberen PHD wielen 65mm geremd
- Holle zwarte PHD wielen 65mm ongeremd
- Holle chromen PHD wielen 65mm ongeremd

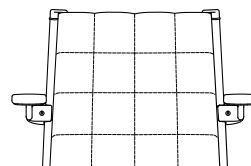

Stiksel Vega Hit S

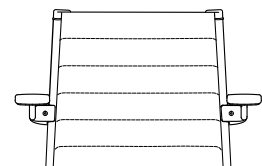

Stiksel Vega Hit L

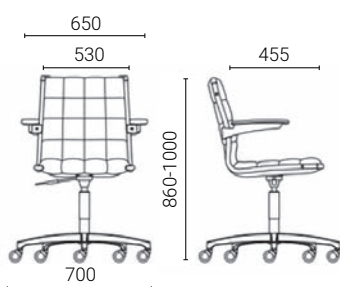

Vega Hit S meeting HV verrijdbaar

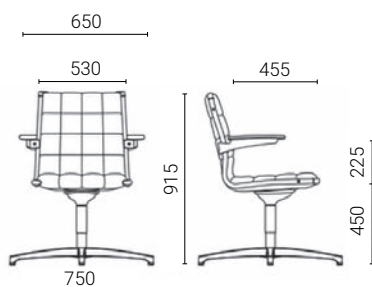

Vega Hit S meeting self return 4 teens

- Wiel 65mm PHD
- Hol wiel 65mm met zwarte support
- Hol wiel 65mm met chromen support



## sitland

Design by Dorigo

De Milos familie bestaat uit een ruime collectie stoelen met een elegante vormgeving en duurzame materialen. Voor elke functie en ruimte een passend model. Milos Elle heeft een PP kuip in diverse kleuren of een gestoffeerde kuip desgewenst met lijnstiksel. Milos Life kan worden uitgevoerd met diverse armleggers en onderstellen. Milos Shell heeft een comfortabele kuip die tevens kan worden geleverd met diverse onderstellen. Laat uw mensen duurzaam en comfortabel zitten met deze prachtige Milos serie.



Milos Elle PP ringframe



Milos Life verrijdbaar met design armleggers



Milos Shell 4-poots hout



Milos Life bar

**Model Milos Elle PP kunststof\***

- Milos Elle PP 4-poots metaal
- Milos Elle PP 4-poots metaal met armleggers
- Milos Elle PP ringpoot metaal
- Milos Elle PP ringpoot metaal met armleggers
- Milos Elle PP barkruk 64h
- Milos Elle PP barkruk 74h

\* Frame in wit, zwart of chroom

**Kunststof kleuren Milos Elle PP**

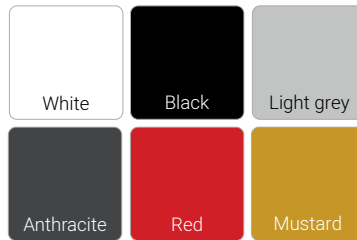

**Model Milos Elle stof plain of lijnstiksel\***

- Milos Elle stof 4-poots metaal
- Milos Elle stof 4-poots metaal met armleggers
- Milos Elle stof ringpoot metaal
- Milos Elle stof ringpoot metaal met armleggers
- Milos Elle stof barkruk 64h
- Milos Elle stof barkruk 74h

\* Frame in wit, zwart of chroom

**Stoffering Milos Elle**



AL-ME-CH-MF-MW  
CS-SY-WI-RM



SC



-

**Model Milos Life gestoffeerd**

- Milos Life 4-poots pyramide hout
- Milos Life 5-teens HV verrijdbaar\*
- Milos Life 4-teens verrijdbaar of glijdoppen\*
- Milos Life 4-teens HV verrijdbaar of glijdoppen\*
- Milos Life barkruk 67h\*
- Milos Life barkruk 77h\*

\*Frame in wit, zwart of chroom

**Stoffering Milos Life**



AL-ME-CH-RG-MF-MW  
CS-SY-YO-WI-FT-RM  
RW-HE-FD-S1-SE-S4



SC



SX+NX

**Model Milos Shell gestoffeerde kuip**

- Milos Shell 4-poots hout
- Milos Shell 4-poots pyramide hout
- Milos Shell 5-teens HV verrijdbaar\*
- Milos Shell 4-teens vaste hoogte\*
- Milos Shell 4-teens HV verrijdbaar\*

\*Frame in wit, zwart of chroom

**Stoffering Milos Shell**



AL-ME-CH-RG-MF-MW  
CS-SY-YO-WI-FT-RM  
RW-HE-FD-S1-S3-S4



-



-

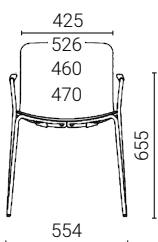

Milos Elle 4-poots met armleggers

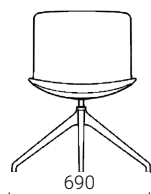
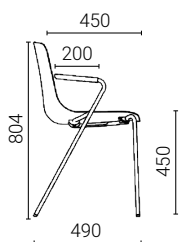

Milos Life 4-teens op glijdoppen



Milos Shell 4-poots pyramide hout

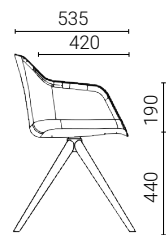

# TERRAS EN KANTINE







## Maya

De Maya is een elegant 4-poots model vervaardigd van 100% recyclebaar polypropyleen. Stapelbaar en geschikt voor binnen en buiten. Uit voorraad leverbaar in 8 kleuren.



- 5994 White
- 6076 Dark grey
- 6083 Tropical green
- 6038 Orange
- 6069 Silver grey
- 6021 Black
- 6045 Light Blue
- 0067 Olive Green

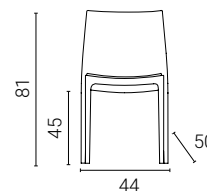

## Diva

Een robuuste armstoel van 100% recyclebaar polypropyleen. Stapelbaar en geschikt voor binnen en buiten. Uit voorraad leverbaar in 8 kleuren.



- 6205 White
- 6274 Dark grey
- 6281 Tropical green
- 6229 Orange
- 6236 Silver grey
- 6243 Red
- 6250 Black
- 6267 Light Blue

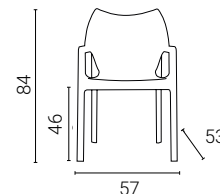



VOORRAAD



GARANTIE



CIRCULAIR



OOK VOOR BUITEN



## Juliette

Stapelbare stoel met een kunststof zitting en rug van 100% recyclebaar polypropyleen en 25mm poten in geanodiseerd aluminium.

Geschikt voor binnen en buiten.  
Uit voorraad leverbaar in 7 kleuren.



2313  
White

2382  
Beige

2368  
Light green

2351  
Orange

2344  
Red

2375  
Black

2399  
Blue

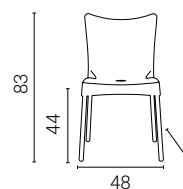

## Romeo

Stapelbare armstoel met een kunststof kuip van 100% recyclebaar polypropyleen en 25mm poten in geanodiseerd aluminium.

Geschikt voor binnen en buiten.  
Uit voorraad leverbaar in 7 kleuren.



2016  
White

2085  
Beige

2061  
Light green

2054  
Orange

2047  
Red

2078  
Black

2092  
Blue

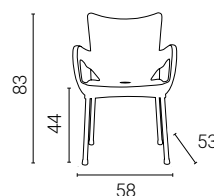



## Helen

Stapelbare stoel met vriendelijk en degelijk 4-pootsframe. Geschikt voor binnen en buiten, uit voorraad leverbaar in 6 kleuren.

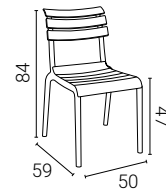

0688  
Black

0695  
Dark grey

0718  
Olive green

0701  
Taupe

0671  
White

0947  
Marsala



## Helen 75 barkruk

Stevige kruk uit één stuk met aangename rugleuning. Zithoogte 75cm geschikt voor bar- en statafels, uit voorraad leverbaar in 6 kleuren.

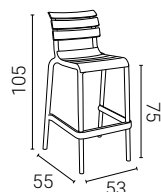

1517  
Black

1524  
Dark grey

1548  
Olive green

1531  
Taupe

1500  
White

1555  
Marsala





VOORRAAD



GARANTIE



CIRCULAIR



OOK VOOR BUITEN



MONTAGE



## Paris

Comfortabele armstoel in één stuk vervaardigd dus extra stevig. Uit voorraad leverbaar in 6 fraaie kleuren.

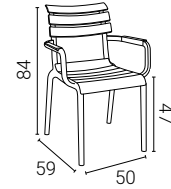

0633  
Black

0640  
Dark grey

0664  
Olive

0657  
Taupe

0626  
White

0930  
Marsala



## Paris tafels

Praktische tafeltjes die tevens als bankje of poef gebruikt kunnen worden. Mooi in combinatie met stoel Paris en Helen, leverbaar als kleine sidetable of iets grotere loungetable in 6 kleuren.

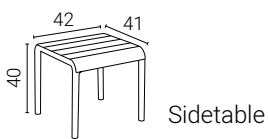
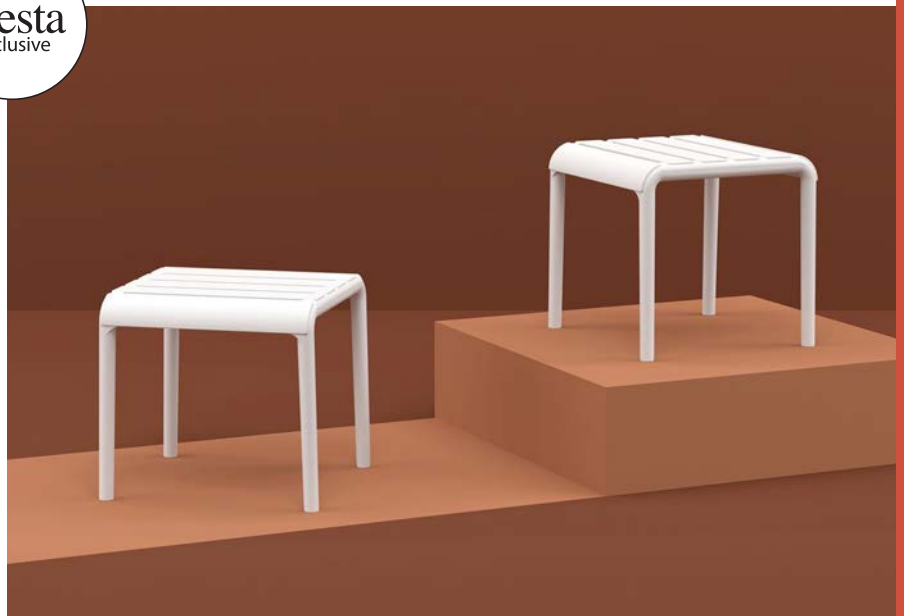

Sidetable

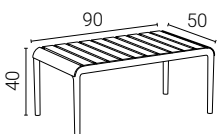

Loungetable



Black

Dark grey

Olive green

Taupe

White

Marsala



## Air

Stapelbaar en 100% polypropyleen uit één vorm. Geschikt voor binnen en buiten. Uit voorraad leverbaar in 8 kleuren.



1736  
Yellow



6540  
White



6588  
Dark grey



6564  
Tropical green



6557  
Orange



6595  
Taupe



6786  
Red



6571  
Black

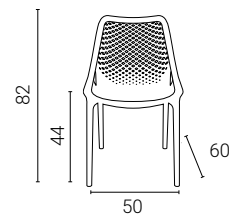

Air



VOORRAAD



GARANTIE



CIRCULAIR



OOK VOOR BUITEN



## Sky pro

Comfortabele stapelbare kuipstoel uit één stuk.  
De Sky Pro is uit voorraad leverbaar in 6 fraaie kleuren en geschikt voor binnen en buiten.

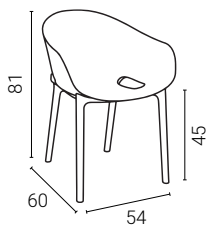

0398  
White



0411  
Dark grey



0404  
Black



0428  
Taupe



0435  
Olive green



0954  
Marsala



## Sky tafel

De Sky 80 en 105 zijn zeer praktische kunststof tafels met een stevige pyramidepoot in UV bestendig PP. De tafels zijn voorzien van rubberen stelvoetjes, geschikt voor binnen- en buitengebruik. Uit voorraad leverbaar in 5 aantrekkelijke kleuren en 2 maten.



Sky 80

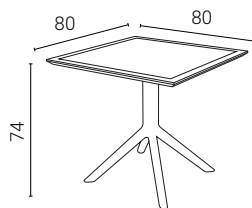

Sky 105

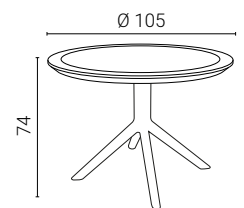



VOORRAAD



4-6  
weken

LEVERTIJD



GARANTIE



CIRCULAIR



OOK VOOR BUITEN



MONTAGE

## Vegas

Stevige 4-poots tafels in UV-bestendig kunststof.

De Vegas is leverbaar in diverse uitvoeringen en middels een slim schuifstelsel in lengte aan te passen. Geschikt voor binnen en buiten. Op bestelling leverbaar (4-6 weken).



### Vegas 100-140



7486  
White

7516  
Black

7493  
Dark grey

7509  
Taupe

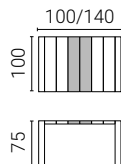

### Vegas medium 180-220



7615  
White

7646  
Black

7622  
Dark grey

7639  
Taupe

### Vegas Bar 100-140



7936  
White

7967  
Black

7943  
Dark grey

7950  
Taupe

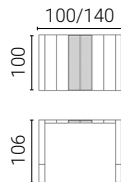

### Vegas XL 260-300



0022  
White

0053  
Black

0046  
Dark grey

0039  
Taupe





SCAN  
VOOR  
PRIJSLIJST

Air barkruk brengt de succesvolle Air tot grote hoogte. Uit voorraad leverbaar in 7 kleuren.



4331  
White

4379  
Dark Grey

4355  
Tropical Green

4348  
Orange

4386  
Taupe

4393  
Red

4362  
Black

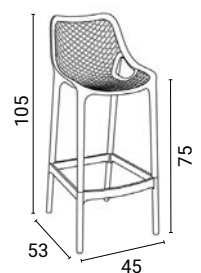

# MAYA BAR



VOORRAAD



GARANTIE



CIRCULAIR



OOK VOOR BUITEN



MONTAGE

279



Uit voorraad leverbaar in 5 kleuren, stapelbaar.



6977  
Black



6168  
White



6984  
Dark Grey



6991  
Taupe



0036  
Olive Green

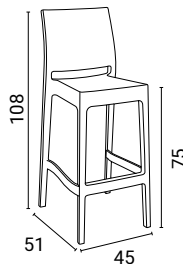



## Bakhita

Handig 4 poots model vervaardigd uit ijzersterk techno polymeer. De stapelbare Bakhita is geschikt voor binnen en buiten en leverbaar in 11 kleuren. Leverbaar vanaf 4 stuks per kleur.

### Model

Bakhita zonder armleggers

Bakhita B met armleggers

Trolley zwart (maximaal 10 stuks)



# Gaber®

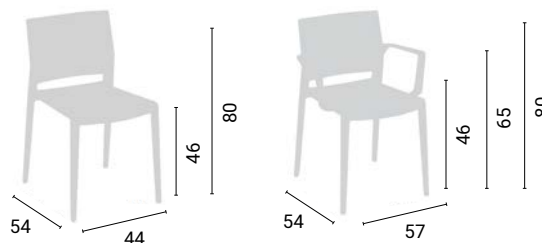

## Bakhita barkruk

Leverbaar in 9 kleuren (vanaf 4 stuks per kleur).

### Model

Bakhita barkruk H66 of H76

Design by  
Eurolinea

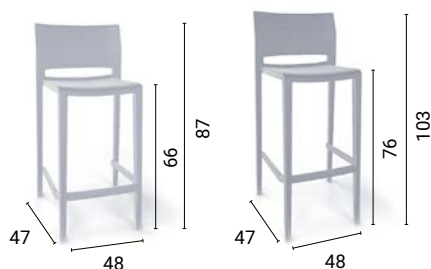





## Lilibet

Leverbaar als handige stapelbare 4-poots stoel met of zonder armleggers. Het techno polymeer frame maakt Lilibet sterk en stabiel. Lilibet is in 8 kleuren beschikbaar waarvan 3 kleuren 100% gerecycled, lekker duurzaam! Leverbaar vanaf 4 stuks per kleur.

### Model

Lilibet zonder armleggers

Lilibet B met armleggers

Trolley zwart

(Lilibet maximaal 14 stuks en de Lilibet B maximaal 8 stuks)



Design by  
Forsix



### Kleuren

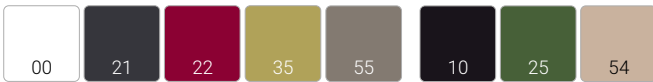

### Zero waste kleuren (100% recycled)

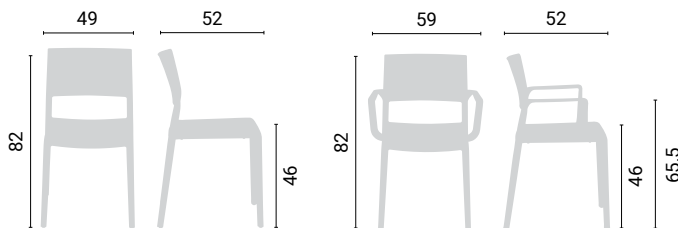

## To-me

Elegante 4-poot stoel met of zonder armleggers, stapelbaar tot max 6st. In 8 kleuren leverbaar waarvan 3 kleuren vervaardigd van 100% gerecycled techno polymeer. Leverbaar vanaf 4 stuks per kleur.

### Model

To-me zonder armleggers

To-me B met armleggers



reddot winner 2023

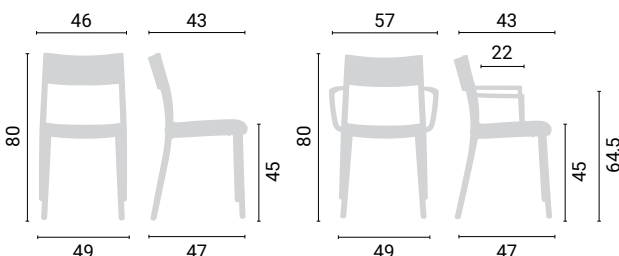

Design by  
Favaretto & Partners

### Kleuren



### Zero waste kleuren (100% recycled)

**BN**

Bondai FIDIVI, 100% Polyester, 150.000 Martindale

**AL**

Alba FIDIVI, 100% Polyester, 100.000 Martindale

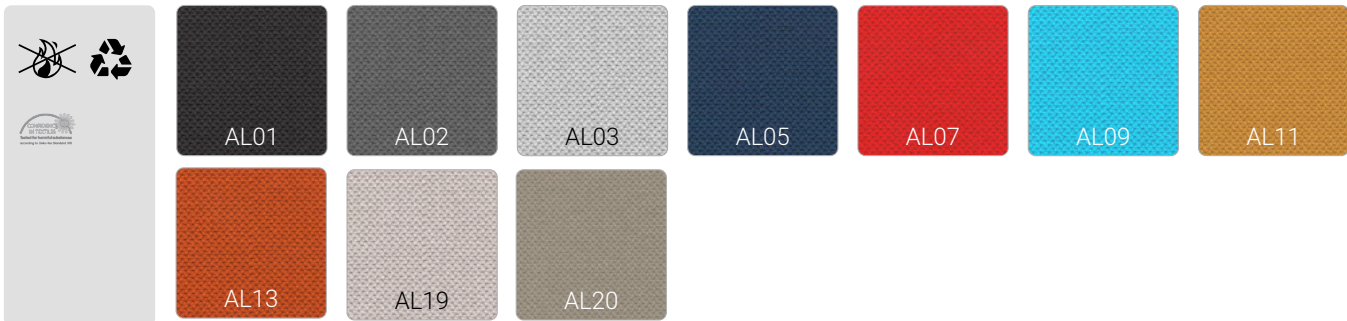
**AB**

Xtreme Plus Camira, 100% post-consumer recycled Polyester, 100.000 Martindale

**ME**

Medley Gabriel, 100% Polyester, 75.000 Martindale

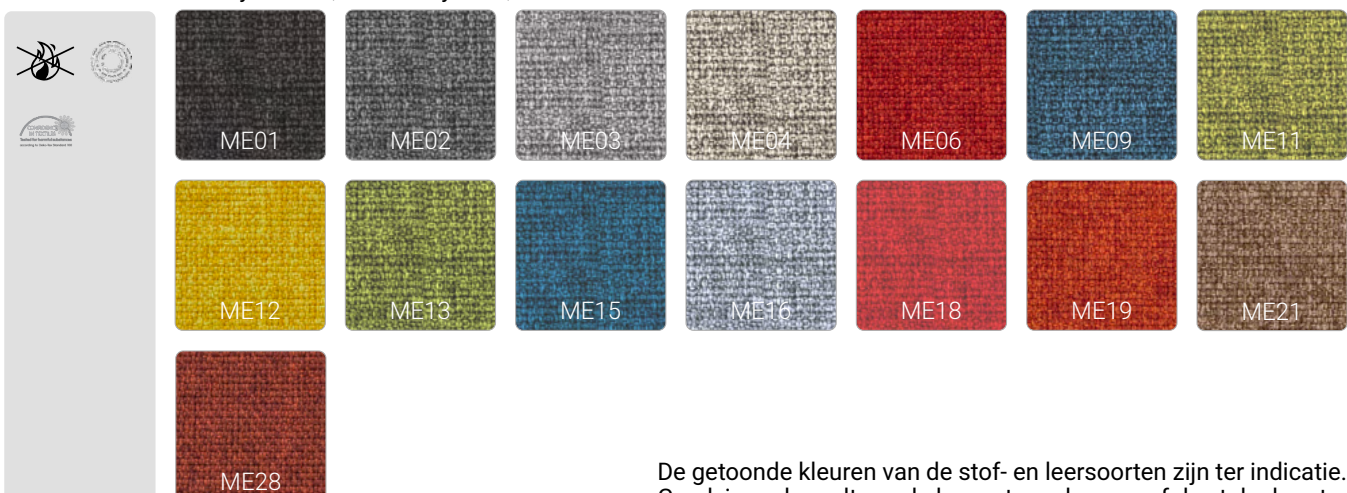

De getoonde kleuren van de stof- en leersoorten zijn ter indicatie.  
Geadviseerd wordt om de keuze te maken vanaf de stalenkaart.

**CH**

Chili Gabriel, 100% post-consumer recycled brandvertraged, Polyester, 60.000 Martindale

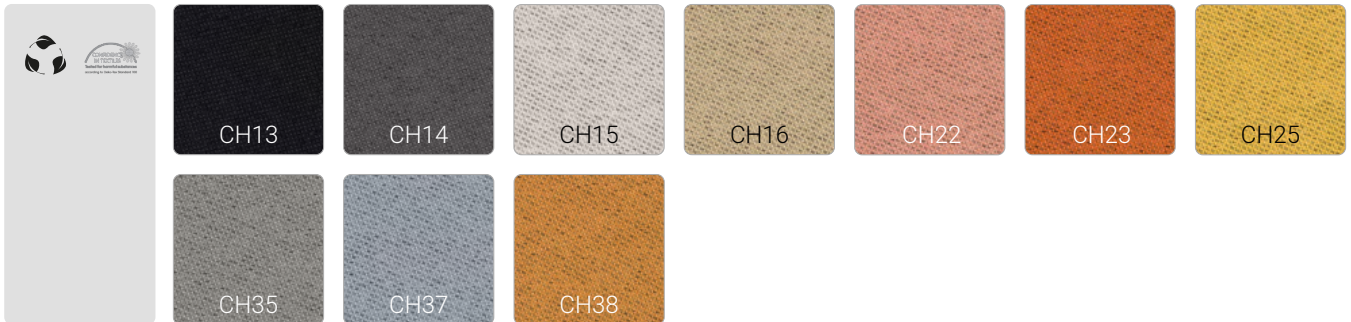

**RG**

Regent Camira, 100% brandvertraged Polyester, 50.000 Martindale



**MW/MF**

Main Line Twist/Main Line Flax Camira, 75% wol, 25% Flax, 50.000 Martindale



**ST**

Step Gabriel, 100% Trevias CS, 100.000 Martindale



**CS**

Crisp Gabriel, 93% Wol uit New Zealand, 7% Polyamide 200.000 Martindale

**SY**

Synergy Camira, 95% WV, 5% Polyamide, 100.000 Martindale

**WI**

Wilson Vescom, 100% post-consumer recycled Polyester, 80.000 Martindale

**YO**

Yoredale Camira, 95% wol, 3% Polyester, 2% Polyamide, 50.000 Martindale

**FT**

Foster Vescom, 97% recycled brandvertragend Polyester, 3% brandvertragend Polyester, 60.000 Martindale

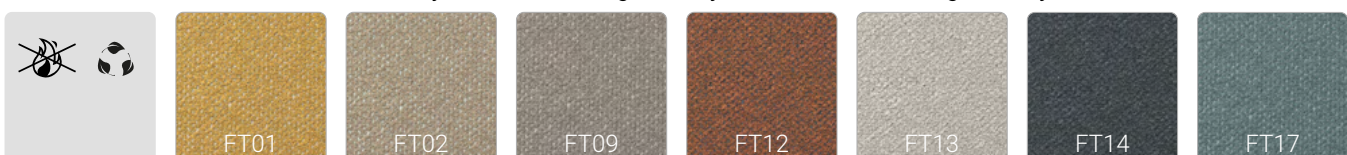

## RF

Mesh Polo FIDIVI, 100% polyester, 100.000 Martindale

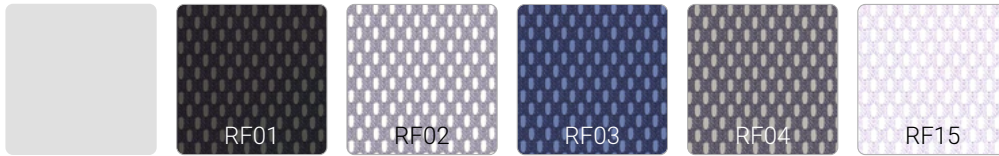

## RR

Runner Gabriel, 100% Polyester, 70.000 Martindale

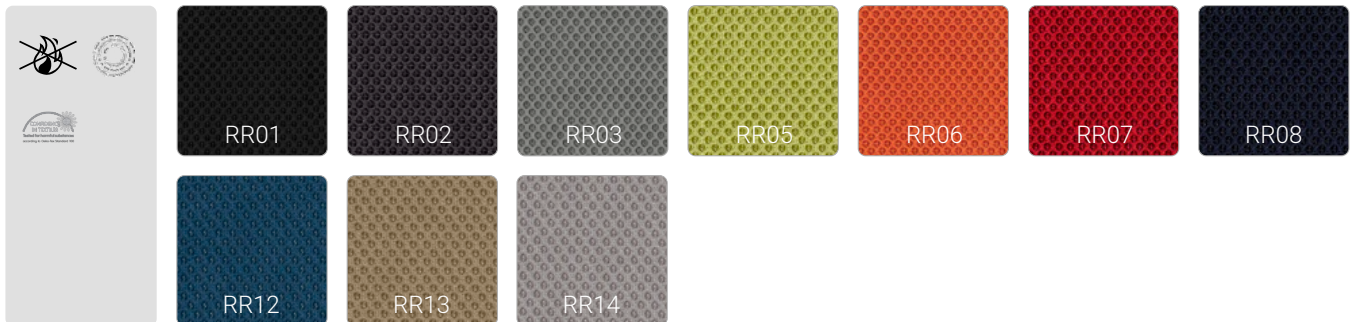

## RP

Net Medium Plastitex, 70% PVC, 30% Polyester, 100.000 Martindale

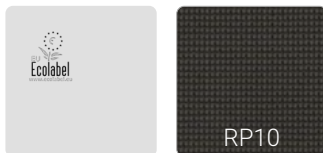

## IR

Iron Fidivi Service, 100% Polyester, 100.000 Martindale



## TT

100% brandvertragend Polyester, 60.000 Martindale

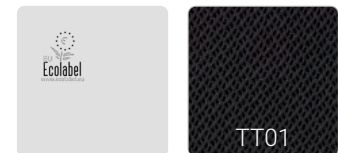

## RY

Rhythm Gabriel, 100% brandvertragend Polyester, 100.000 Martindale

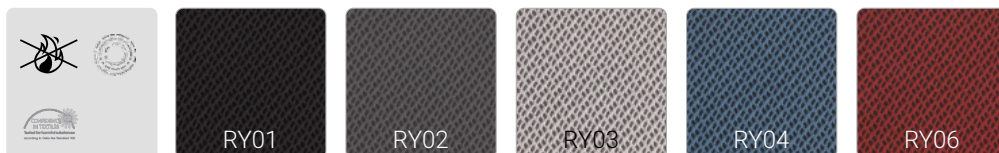

## SC

Kunstleder Flukso Secret, 76% PVC, 2% PU, 22% PES, 60.000 Martindale



 **NX**

Kunstleder Lederplast, 91% PVC, 9% Polyester, 60.000 Martindale

 **SX**

Box Land Dani, 100% europees leder - ISO 14025 EPD

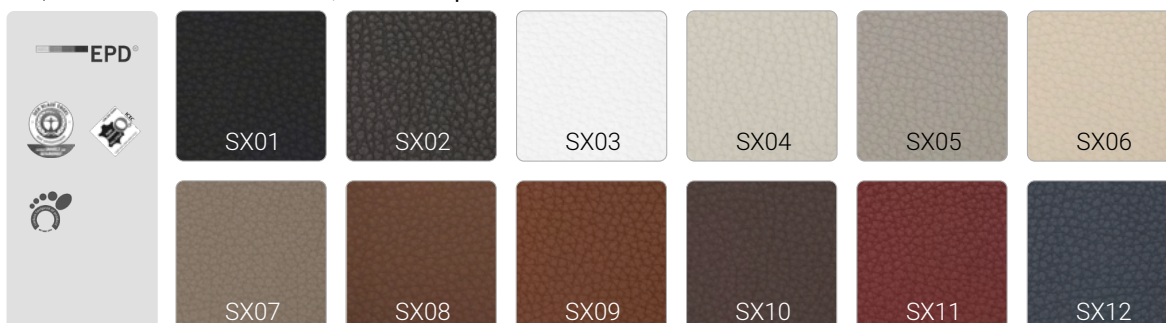
 **PA**

Panama Dani, 100% europees leder - ISO 14025 EPD

 **TS**

Florida Dani, 100% europees fijn nappaleder - ISO 14025 EPD



De getoonde kleuren van de stof- en leersoorten zijn ter indicatie.  
Geadviseerd wordt om de keuze te maken vanaf de stalenkaart.

## FD

Flord 2, 92% wol, 8% nylon, 60.000 Martindale

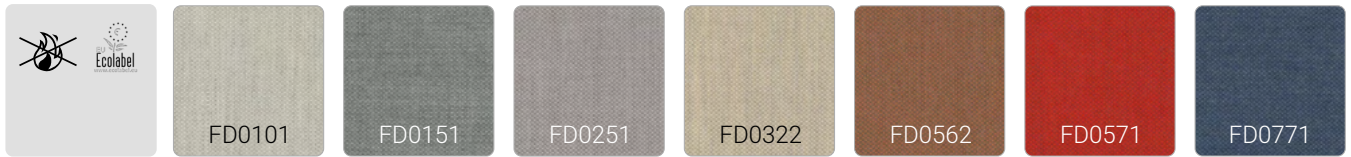

## HE

Hero 2, 97% wol, 3% recycled nylon, 45.000 Martindale

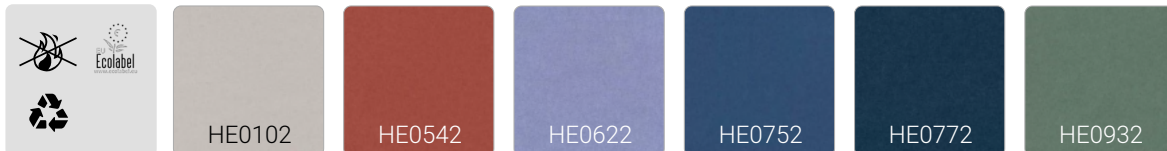

## RM

Remix 3 Kvadrat, 90% wol, 10% nylon, 100.000 Martindale



## RW

Re-Wool Kvadrat, 45% recycled wol, 45% wol, 10% nylon, 100.000 Martindale

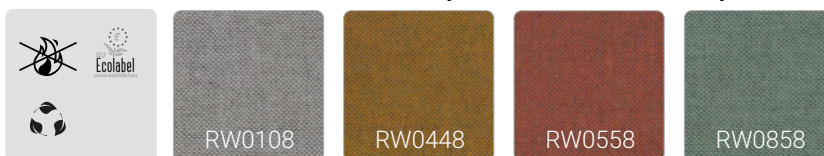

**S1**

Steelcut 3 Kvadrat, 90% wol, 10% nylon, 100.000 Martindale

**SE**

Steelcut Trio 3 Kvadrat, 90% wol, 10% nylon, 100.000 Martindale

**S4**

Steelcut Quartet Kvadrat, 90% wol, 10% nylon, 100.000 Martindale

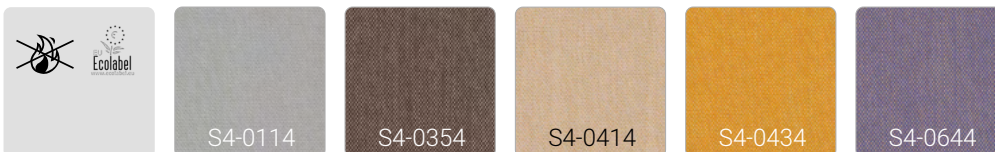



Symbol	Omschrijving
	Geen zware metalen
	EU Ecolabel is een Europees merk dat de verminderde milieu-impact van het product certificeert
	Gemodificeerde polyestervezel "Permanent Vlamvertragend": in staat om de vlamvertragende eigenschappen van de vezel te behouden bij veroudering, slijtage en wassen. Stoffen gemaakt met Trevira CS-vezel doorstaan de zwaarste tests (Klasse 1 in Italië)
	GREENGUARD-certificering is een Europees merk dat het lage niveau van chemische emissies certificeert
	Het Oeko-Tex® STANDARD 100-label garandeert dat elk onderdeel van het artikel is getest op schadelijke stoffen en dat het artikel daarom onschadelijk is in humaan ecologische termen
	Verhindert de groei van bacteriën en geurontwikkeling, ingebouwde duurzame bescherming dankzij de Sanitized® hygiënefunctie
	Der blaue Engel (RAL UZ 148) stelt strengere limieten voor het gehalte aan gevaarlijke stoffen, de uitstoot van verontreinigende stoffen en het gebruik van grondstoffen en water dan wettelijk is voorgeschreven
	Leer uit Italië volledige cyclus (UNI EN 16484) verklaart dat alle productieprocessen in Italië worden uitgevoerd
	Carbon footprint van product (ISO 14067:2018) kwantificeert de uitstoot van broeikasgassen in de toeleveringsketen.
	Milieuproductverklaring & proces EPD (ISO 14025) N.a.v. de LCA (Life Cycle Assessment) studie worden de volgende impactcategorieën onderzocht: broeikaseffect, vermindering van de ozonlaag, verzuring, fotochemische smog, eutrofiërin
	Echt leder
	Eco leder
	Brandvertragend
	Recyclebaar
	Duurzaam - gerecycled
PA	Polyamide
PL	Polyester
PL Fr	Brandvertragend polyester
Tr cs	Trevira CS
W	Wol
WV	Onbewerkte Wol



Milos Lounge

**B01**

Stof B01, 100% polyester FR Trevira CS, 100.000 Martindale (brandwerend EN1021-1+2 en BS5852-1)

**B03**

Ecoleder B03, 76% PVC, 2% PU en 22% polyester, 75.000 Martindale (brandwerend EN1021-2 en BS5852-1)

**C01**

Stof C01, 100% polyester FR Trevira CS, 70.000 Martindale (brandwerend EN1021-1+2 en BS5852-5)





**C05**

Gabriel C05, 100% polyester FR Trevira CS, 100.000 Martindale (brandwerend EN1021-1+2 en BS5852-5)

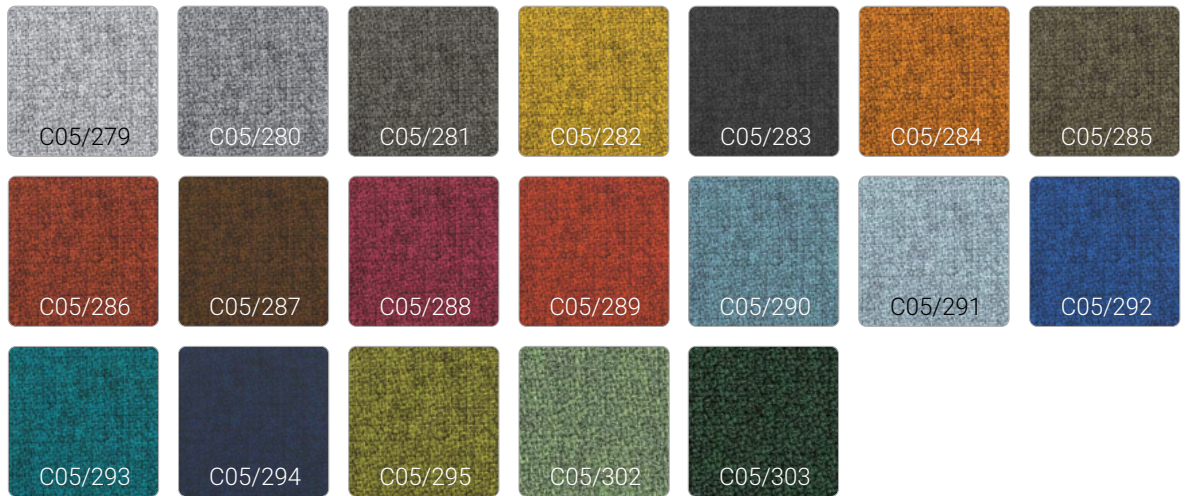

**D06**

Kunstleder D06, PVC en polyster, 300.000 Martindale (brandwerend EN1021-1+2 en BS5852-5)



**P01**

Leder P01, 100% Europees leder



**D02**

Stof D02, 100% polyester FR Trevira CS, 100.000 Martindale (brandwerend EN1021-1+2 en BS5852-5)



**D03**

Stof D03, 75% wool, 25% polyester, 100.000 Martindale (brandwerend EN1021-1+2 en BS5852-5)

**D04**

Stof D04, 68% polyester, 32% polypropyleen, 135.000 Martindale (brandwerend EN1021-1+2)

**D05**

Stof D05, REPVEVE® recycled polyester gemaakt van gebruikte plastic flessen, ≥80.000 Martindale (brandwerend EN1021-1+2 en BS7176 laag en medium risico)





**E01**

Stof E01, 85% Nieuw-Zeeland wol, 15% polyamide, 200.000 Martindale (brandwerend EN1021-1+2 en BS5852-5)

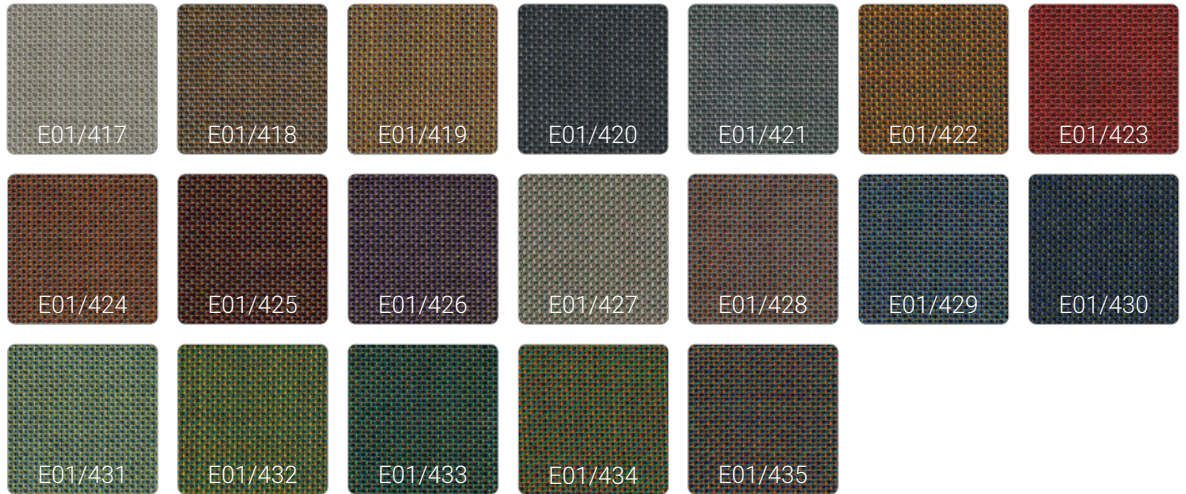

**E02**

Stof E02, 85% Nieuw-Zeeland wol, 15% polyamide, 200.000 Martindale (brandwerend EN1021-1+2 en BS5852-1)



**E03**

Stof E03, 75% puur nieuw wol, 25% vlas, >100.000 dubbele wrijvingen Wyzenbeek (brandwerend BS7176 laag risico)



**E04**

Stof E04, 100% polyester, 150.000 Martindale (brandwerend EN1021-1+2 en BS5852-5)

**I01**

Stof I01, 100% polyester, 50.000 Martindale (brandwerend BS5851-0-1)

**I02**

Stof I02, 92% nieuwe wollen kamgaren, 60.000 Martindale (brandwerend EN1021-1+2 en BS5852-5)





**M01**

Stof M01, 85% wol, 10% vlas en 5% nylon, >100.000 Martindale (brandwerend BS7176 medium risico)

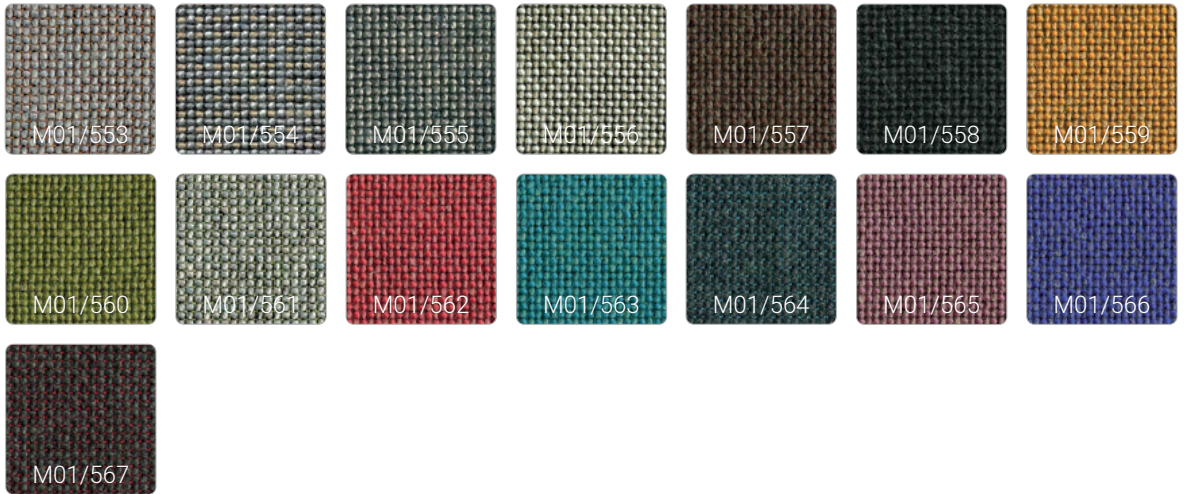

**M02**

Stof M02, 100% wol, 45.000 Martindale (brandwerend EN1021-1+2 en BS5852-5)



**M03**

Stof M03, 100% wol, 45.000 Martindale (brandwerend EN1021-1+2 en BS5852-5)



**K**

King Trevira CS 100% Polyester, UNI EN ISO 12947-2, 80.000 Martindale



**B**

Blazer Camira, 100% onbewerkte wol, 65.000 Martindale, BS EN ISO 12947



**DK**

Kvadrat Steelcut 3, 90% scheerwol en 10% nylon, 100.000 Martindale, EN12947





**DK**

Kvadrat Remix 3, 90% wol en 10% nylon, 100.000 Martindale, EN12947

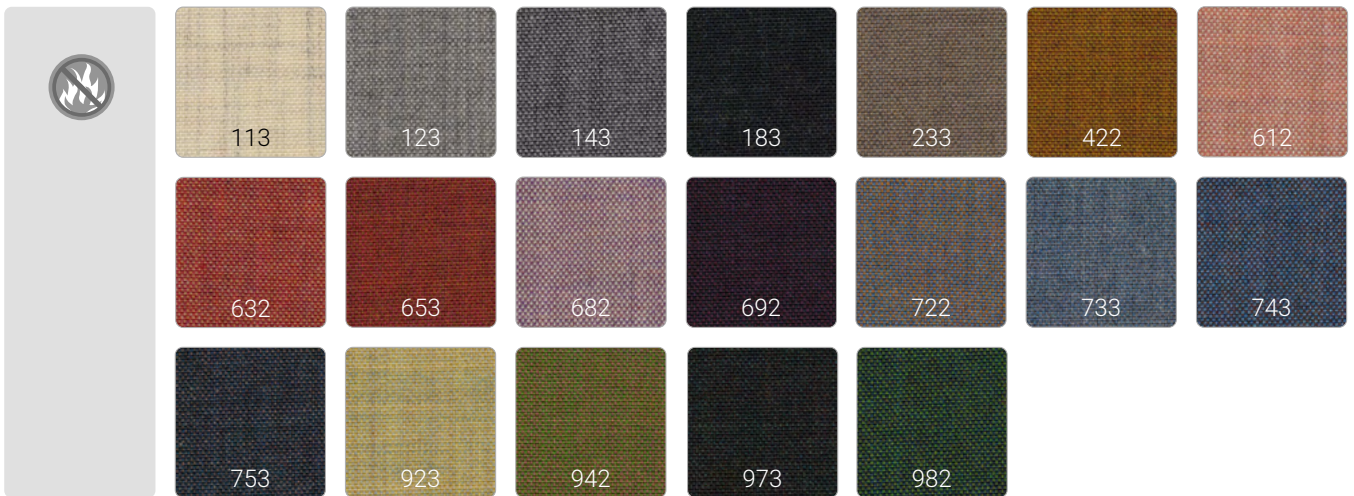

**MG**

Maglia vinyl, 100% vinyl, 100.000 Martindale, EN ISO 12947:1999 part 2

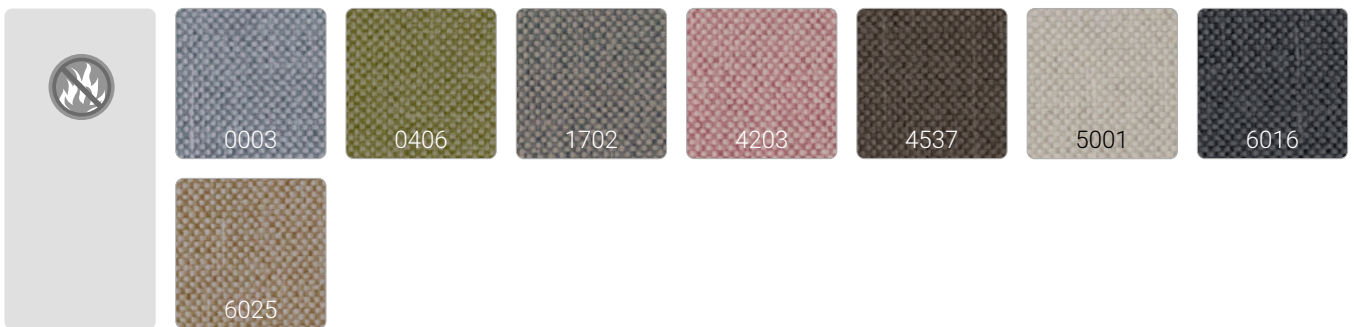

**SX**

Silvertex, 100% vinyl met polyester backing, 300.000 Martindale, EN ISO 12947:1999 part 2



 **E**

Simil ecoleder Aurea, 72% PVC en 25% katoen, 100.000 Martindale, EN ISO 5470-2



**S**

Superb Trevira CS, 100% polyester, 100.000 Martindale, UNI EN ISO 12947

**P**

100% topkwaliteit leder, Italiaanse leerlooierij, lichtweerstand-Xenotest UNI EN ISO 105-B02/6



**CARA**

Camira, 100% polypropyleen, 250gr/m2, brandwerendheid BS476-7 class 1/BSEN1021-1



**I**

Fabraa, voor: 60% RPET en 40% PES, achter: 100% RPE, >100.000 Martindale brandwerendheid EN ISO 12947/2, BS5852 part 1



De getoonde kleuren van de stofsoorten zijn ter indicatie.  
Geadviseerd wordt om de keuze te maken vanaf de stalenkaart.









Waar treft u onze producten aan?

**vet** = pagina met alle productinformatie (dun = pagina waar product is afgebeeld)

## A

<b>Ado soft seating</b>	<b>36-37</b>
<b>Air barkruk</b>	128, <b>278</b>
<b>Air stoel</b>	<b>274, 277</b>
<b>Air2 bartafel</b>	<b>138</b>
<b>Air2 bureau</b>	59, <b>56-57</b>
<b>Air2 Co-Work tafel</b>	<b>134-135</b>
<b>Air2 vergadertafel</b>	124-125, <b>136-137</b>
<b>Afra</b>	<b>117</b>
<b>Akami stoel</b>	<b>245</b>
<b>Akoestische achterwand</b>	161
<b>Arca bartafel</b>	<b>138</b>
<b>Arca bureau</b>	58-59, <b>54-55</b>
<b>Arca vergadertafel</b>	<b>136-137</b>
<b>Arco</b>	15
<b>Argo Libro vouwtafel</b>	<b>130-131</b>
<b>Arket tafel</b>	240, 281
<b>Artesia stoel</b>	<b>240-241</b>
<b>Askia Kameleon</b>	<b>44-45</b>
<b>Asso soft seating</b>	46
<b>Astro Twist</b>	<b>24-25</b>
<b>Avana soft seating</b>	<b>26-27</b>

## B

<b>Babel lamp</b>	142
<b>Bakhita barkruk</b>	<b>280</b>
<b>Bakhita stoel</b>	<b>280</b>
<b>Basic+ scheidingswand</b>	<b>104-105</b>
<b>Basket stoel</b>	<b>246</b>
<b>Benchklem</b>	<b>103, 105</b>
<b>Bi-Box inbouwmodule</b>	<b>156</b>
<b>Bistrot tafel</b>	<b>35</b>
<b>Boekensteun SE</b>	<b>169</b>
<b>Boiserie kast</b>	57, 182-183

## C

<b>Canapé banken</b>	<b>38-39, 50</b>
<b>CD LED</b>	<b>115</b>
<b>Cell 72 soft seating</b>	<b>42</b>
<b>Cell 75 soft seating</b>	<b>43</b>
<b>Cell 128 soft seating</b>	12, <b>40-41</b>
<b>Cell Space akoestisch</b>	<b>40-41</b>
<b>Chicago monitorarm</b>	<b>123</b>
<b>City Déco stoel</b>	145, 150, <b>249</b>
<b>City Déco Lounge</b>	33, 46
<b>City kuipstoel</b>	146, 148, 152, 154, <b>248</b>

City lounge stoel	32, 116
Clark barkruk	144
Classic en Classic+ bureaustoel	226-227
Classic en Classic+ meetingstoel	226-227
Classic en Classic+ visitor	126, 136, 226-227, 262
Cleopas stoel	30-31, 117
Componenten bureaus	58-61
Cove barkruk	250-251
Cove kuipstoel	71, 250-251
CPU houders	122
Cucaracha stoel	20
Custom NPR bureaustoel	204-205
Custom Pro NPR	206-207
Custom Thor NPR	88, 92, 98, 208-209

## D

Dame stoel	247
Diade Rock bureaustoel	68-69, 94-95
Diepteschothje	65-66
Directa stoel	184, 198
Diva soft stoel	192, 194
Diva stoel	270
Dodo poef	28
Dream klapstoel	239

## E

E-10 directiemeubilair	184-185, 196-197
ECO-light	84, 112-113
ECO-screen wanden	79, 86, 88, 92, 106-109, 161
Ecotec roldeurkast	164-165
Elektrificatie werken	120-121
Elektrificatie vergaderen	156-157
Elite ladenblok	66
Entrada bureau	50, 52-53
Entrada vergadertafel	136-137

## F

Fenix HPL bladen	51
Flap klapstoel	238
Flex accessoires	96-97
Flex 3+ bench	50-51, 88-89, 90, 108, 130
Flex 3+ bench wang	48-49, 90, 92-93
Flex 3+ bureau	67, 82-83
Flex 3+ hoekbureau	84-85, 90
Flex 3+ manager	94-95
Flex 3+ meetingtafel	84, 152-153
Flex 3+ wangbureau	86-87, 106
Flex Eco+ bureau	80-81
Flex Raster bureau	76-77
Flexy kabelgoot	119
Follow Desk	98-99, 208

Follow Bench	99
Follow Break en Meeting	150-151
Follow Tilting	150-151
Freestand Meeting	154-155

## G

Galaxy monitorarm	84, 123
Grace verlichting	26, 33, 116

## H

Hangmappenframe BSL	169
Helen stoel	128, 272
Helen barkruk	272
HPL-bladen	51

## I

Idea+ 01 bureau	29, 69, 248
Idea+ Tube bureau	68

## J

Join vergaderstoel	152, 254-255
Joy kruk	12, 28, 41
Jubel stoel	243
Juliette stoel	271

## K

Kabelbak incl. kleppen	88-89, 96-97
Kabelbak telescopisch	90-91, 92-93
Kabelbeugel	118
Kabeldoorvoerdoppen	119
Kabelgoten bureau	97, 119
Kabelgrip	118
Kabelkorf	119
Kabelslang	119
Kantinetafel 4-All	139
Kanvas stoel	244
Kanvas barkruk	147
Kolomtafels	146-147
Koppelgoot bench	88, 97

## L

Ladenschotje	65-66
Leaf bureaustoel	53, 55, 216-217
Legbord roldeurkast	165, 166-167, 169
Libreria kast	15, 158-159, 180-181, 184, 186, 190
Lido soft seating	22-23
Lilibet kantinestoel	281
Line bureaustoel	224-225
Line meetingstoel	224-225
Lockerkasten melamine	179
Lockerkasten metaal	171-173
Lol tafel	242

## M

Mara 230 tafel	147
Mara 250 tafel	147
Mara 253 tafel	146
Mara 258 tafel	146
Maya barkruk	279
Maya stoel	139, 270
Melamine bladen	51
Melamine ladenblok	67
Melbourne tafel	33, 116
Memory unit (Flex)	97
Mesh-Line bureaustoel	214-215
Miami tafel	24, 30, 36, 47
Milos Lounge	34-35
Milos stoel	142, 236-237, 266-267
Mirage hanglamp	192
Monitorarmen	122-123
Montreal tafel	12, 16, 31, 47
Moon stoel	29
Mute scheidingswand	102-103
Mute vrijstaande wanden	110-111

## N

Neutral ladenblok	64-65
Neutral Plus ladenblok	64-65
New Generation kast	166-167
NG draaideurkast	170
NG open kast	170
Nova bureaustoel	212-213
Nuta stoel	242
Nuta Light stoel	134, 242

## O

Of Course executive stoel	234-235
Of Course manager stoel	234-235
Of Course meeting stoel	234-235
Of Course visitor sledemodel	234-235
Ola lamp	30, 124-125
Ombouwsets kasten	168
Oxygen bureaustoel	70, 76

## P

Paris stoel	128, 273
Paris tafels	273
Passepartout stoel	55, 258-259
Pennenbakje ladenblok	65-66
Pipes hanglamp	196
PK vergaderstoel	124-125, 134, 260-261
Plantenbak melamine	163, 168
PL-1 persoonlijke lade	62
PL-S persoonlijke lade	63
Planet	14, 16, 114, 140, 200, 236

Power Cube	121
Power Desk In	121, 157
Power Desk in Slide	157
Power Desk Insert	157
Power Desk Up	120
Power Spot	120

## Q

Q4 melamine kasten	174-175
Q4 ladenblokken	67, 80, 98, 208
Q4 lockerkasten	179
Q4 meetingtafels	148-149
Q4 metalen kasten	176-177, 236
Q4 schuifdeurkasten	178
Q4 wanden	71
QI Power Pop-Up	157

## R

Rest tafel	34-35
Roldeurkast accessoires	169
Romeo stoel	271

## S

S-Light slinger	74-75
S-line tafel	63, 78-79
Salontafels	46-47
Sit-It executive stoel	232-233
Sit-It manager stoel	232-233
Sit-It meeting stoel	232-233
Six tafel	249
Skate bureaustoel	40, 113, 210-211
Sky Pro stoel	268-269, 275, 276
Sky tafel	273, 275, 276
Slide & Go kasten	50-51, 160-163
Slot Fill stoel	136
Soul stoel	22, 132, 252-253
Spirit en Spirit Air bureaustoel	48-49, 222-223
Spot Plus inbouwmodule	121
Starlight verlichting	26
Stekkerdozen en snoeren	120, 157
Sun lamp	38
Sun kabelgoot	119
SW-1 bureaustoel	74, 78-79, 82, 84, 86, 95, 106, 202-203

## T

T02 kolomtafel	46
T05 salontafel	32, 36, 46
T45 bureau	186-187
T45 meeting	188-189, 236-237
Team Strike bureaustoel	50-51, 57, 130, 218-219
Team Strike Evo bureaustoel	220-221
TH02 CPU houder	122



<b>Timmy Libro vouwtafel</b>	<b>132-133</b>
<b>Timmy-R klaptafel</b>	<b>128-129</b>
<b>T-Meeting 1 tafel</b>	<b>140-141, 200-201</b>
<b>T-Meeting 3 tafel</b>	<b>142-143</b>
<b>T-Meeting 4 tafel</b>	<b>144-145</b>
<b>Tobi soft seating</b>	<b>34</b>
<b>To-Go</b>	<b>20-21</b>
<b>To-me</b>	<b>281</b>
<b>Topbladen kasten</b>	<b>168</b>
<b>Turn &amp; Go klaptafel</b>	<b>126-127</b>
<b>Turn kabelgoot</b>	<b>119</b>

## U

<b>Uni sledestoel</b>	<b>256-257</b>
-----------------------	----------------

## V

<b>Vega executive stoel</b>	<b>228-229</b>
<b>Vega manager stoel</b>	<b>228-229</b>
<b>Vega meeting stoel</b>	<b>140, 200-201, 228-229</b>
<b>Vega visitor sledemodel</b>	<b>228-229, 263</b>
<b>Vega Hit executive stoel</b>	<b>230-231</b>
<b>Vega Hit manager stoel</b>	<b>230-231</b>
<b>Vega Hit meeting stoel</b>	<b>230-231, 264-265</b>
<b>Vegas bartafel</b>	<b>277, 279</b>
<b>Vegas tafel</b>	<b>268-269, 277</b>

## W

<b>Warm lamp</b>	<b>36, 236</b>
------------------	----------------

## X

<b>X2 meeting tafel</b>	<b>149</b>
<b>X4 werkplekken</b>	<b>70, 250</b>
<b>X5 bureau en meeting</b>	<b>190-191</b>
<b>X7 bureau en meeting</b>	<b>192-193</b>
<b>X8 bureau en meeting</b>	<b>194-195</b>
<b>X10 bureau en meeting</b>	<b>198-199</b>

## Z

<b>Z1 balie</b>	<b>14-15, 114</b>
<b>Z2 balie</b>	<b>16-19, 24, 32</b>
<b>Zichtschoot metaal</b>	<b>61</b>



Uitgave 2024  
Model- en kleurwijzigingen voorbehouden.

Design en Grafische verzorging:  
Wendrich  
[www.wendrich.nl](http://www.wendrich.nl)





SWAN-PRODUCTS

[www.swan-products.nl](http://www.swan-products.nl)